

W1-1L

W1-1R
TURN

See page 6-2 for symbol design.

A	B	C	D	E	F	G	H	J	K	L	M	N
18	.375	.625	7.25	2.25	2.625	5.875	3.75	1.875	1	.625	2.5	1.5
24	.375	.625	9.625	3	3.5	7.75	5	2.5	1.5	.813	3.25	1.5
30	.5	.75	12	3.75	4.375	9.688	6.25	3	1.875	1	4.063	1.875
36	.625	.875	14.375	4.5	5.25	11.625	7.5	3.625	2.25	1.25	4.875	2.25
48	.75	1.25	19.188	6	7	15.5	10	4.875	3	1.625	6.5	3

C

WARNING SIGN COLORS:
LEGEND – BLACK
BACKGROUND– YELLOW (RETROREFLECTIVE)

TTC SIGN COLORS:
LEGEND – BLACK
BACKGROUND– ORANGE (RETROREFLECTIVE)

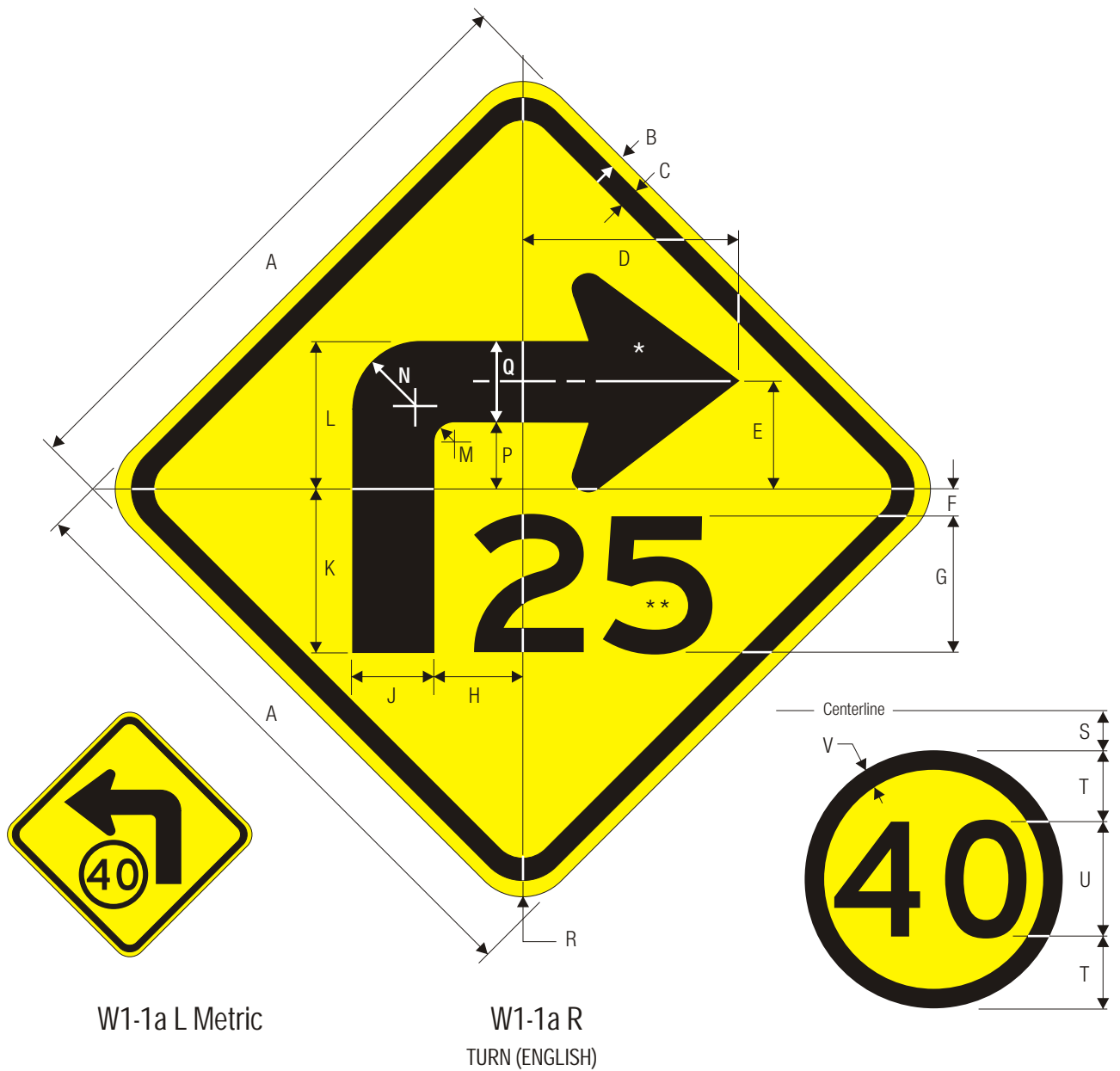

*See page 6-2 for symbol design.
**Optically locate numerals.

A	B	C	D	E	F	G	H	J	K	L	M
30	.5	.75	10.648	5.284	2	6 E	4.363	4	8	7.282	1
36	.625	.875	13.330	6.645	2.922	7 E	5.444	5	9.927	9.123	1.321
48	.75	1.25	18.654	9.327	5.043	9 E	7.605	7	14.050	12.844	1.801

N	P	Q	R	S	T	U	V
3.202	3.282	4	1.875	.960	3.5	5 D	.75
4	4.123	5	2.25	1.160	4.25	6 D	.875
5.604	5.844	7	3	1.561	5.604	8 D	1.25

COLORS: LEGEND — BLACK
BACKGROUND— YELLOW (RETROREFLECTIVE)

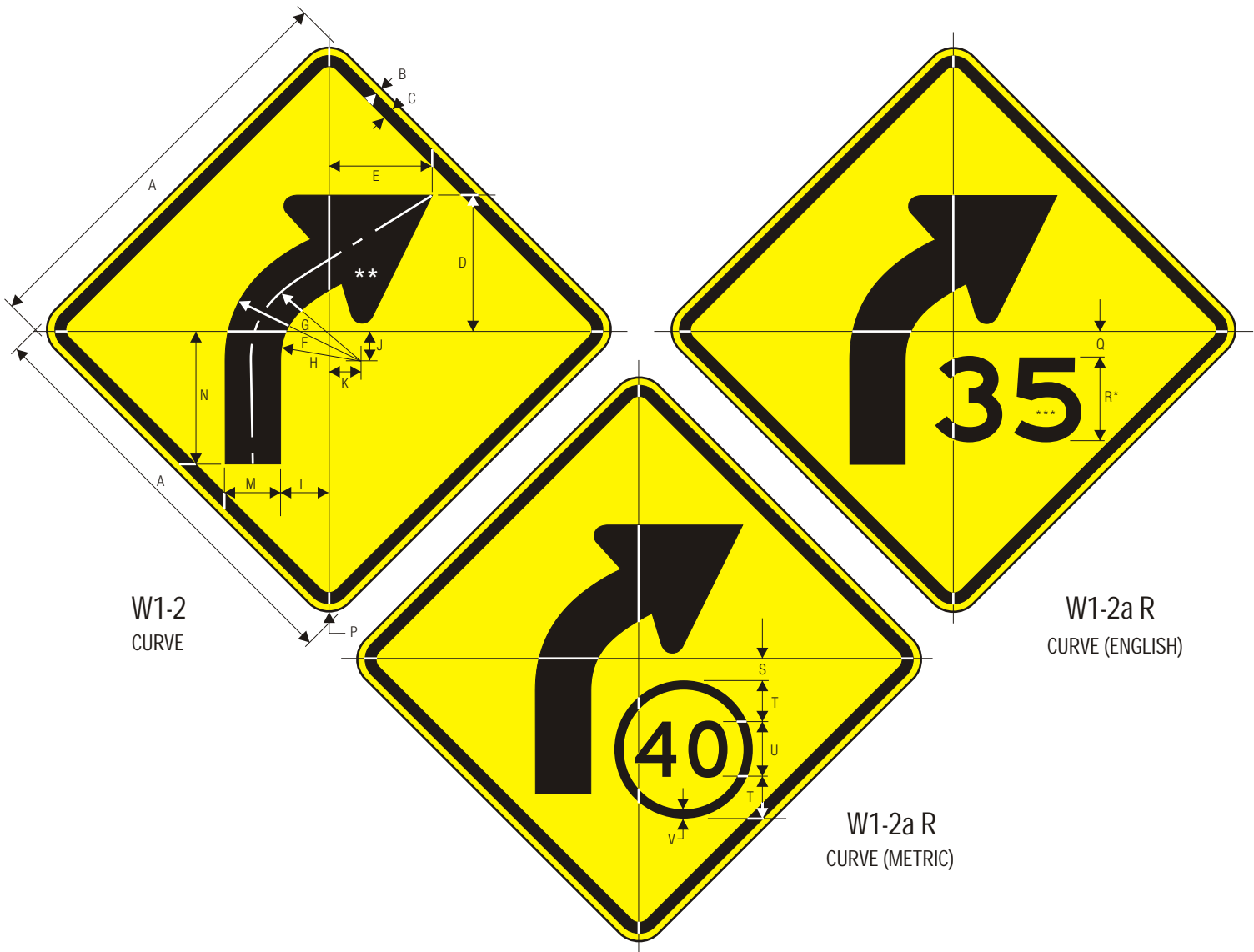

W1-2
CURVE

W1-2a R
CURVE (ENGLISH)

W1-2a R
CURVE (METRIC)

A	B	C	D	E	F	G	H	J	K	L	M
18	.375	.625	5.405	5.144	6	4.687	3.375	1.75	1.312	2.06	2.625
24	.375	.625	7.094	7.25	8	6.25	4.5	2.344	1.75	2.75	3.5
C 30	.5	.75	8.875	9.063	10	7.813	5.625	2.938	2.188	3.438	4.375
36	.625	.875	10.625	10.875	12	9.375	6.75	3.5	2.625	4.125	5.25
48	.75	1.25	14.188	14.5	16	12.5	9	4.688	3.5	5.5	7

N	P	Q	R	S	T	U	V
6.187	1.5	1.5	4 E	1	1.75	2 D	.375
8.25	1.5	2.5	5 E	1.5	2.5	3 D	.5
10.313	1.875	2	6 E	1.5	3	4 D	.625
12.375	2.25	3	7 E	1.813	3.5	5 D	.750
16.5	3	5	9 E	3	5	6 D	1.25

*See page 6-2 for symbol design.
**Optically position numerals.

WARNING SIGN COLORS:
LEGEND — BLACK
BACKGROUND— YELLOW (RETROREFLECTIVE)

TTC SIGN COLORS:
LEGEND — BLACK
BACKGROUND— ORANGE (RETROREFLECTIVE)

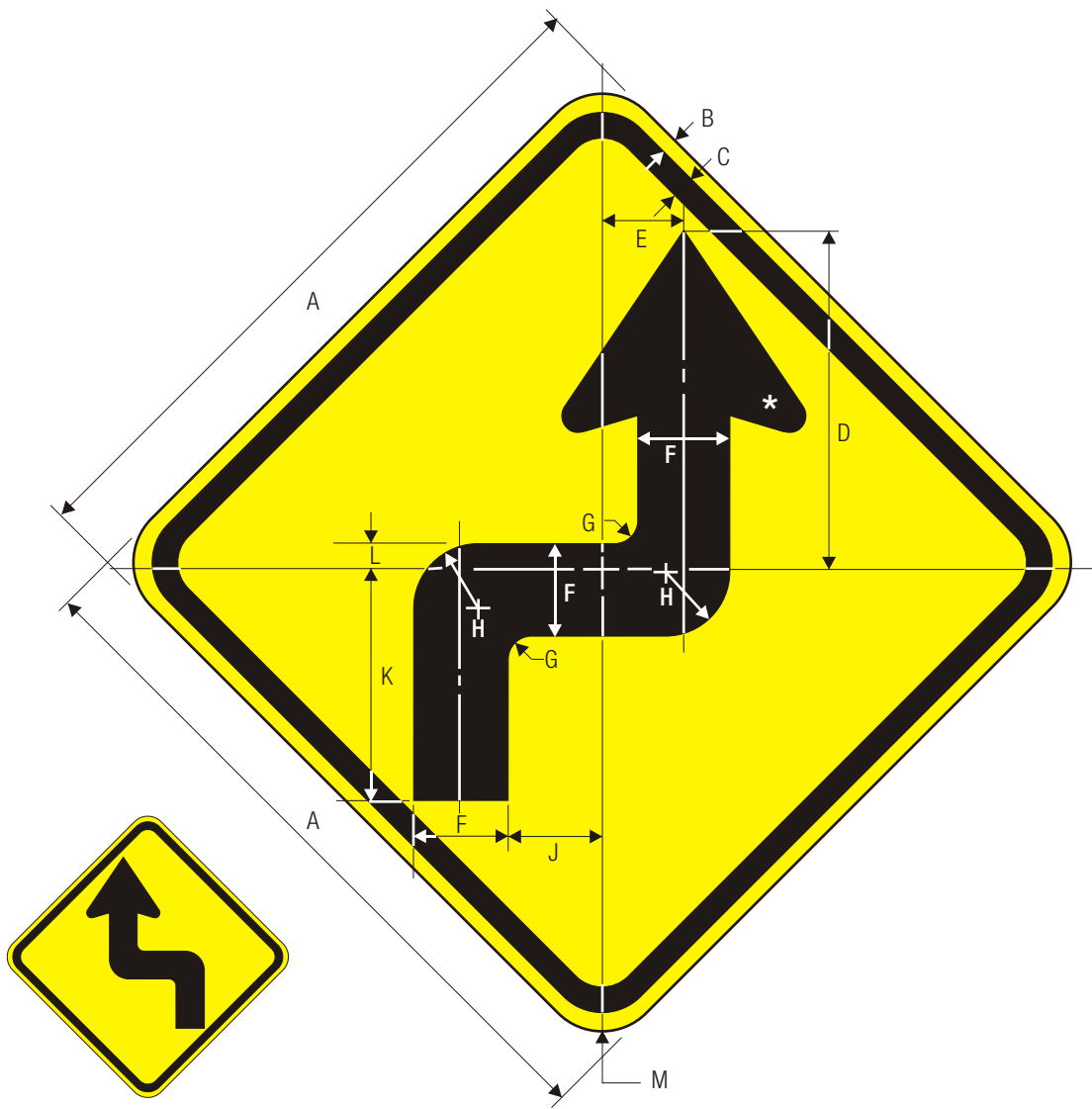

W1-3L

W1-3R
REVERSE TURN

*See page 6-2 for symbol design.

A	B	C	D	E	F	G	H	J	K	L	M
18	.375	.625	8.719	2.109	2.625	.625	1.812	2.25	6.234	.828	1.5
24	.375	.625	11.594	2.813	3.5	.813	2.5	3	8.313	1.094	1.5
C 30	.5	.75	14.5	3.5	4.375	1	3	3.75	10.375	1.375	1.875
36	.625	.875	17.438	4.219	5.25	1.25	3.625	4.5	12.469	1.656	2.25
48	.75	1.25	23.188	5.625	7	1.625	4.875	6	16.625	2.188	3

WARNING SIGN COLORS:
 SYMBOL – BLACK
 BACKGROUND– YELLOW (RETROREFLECTIVE)

TTC SIGN COLORS:
 SYMBOL – BLACK
 BACKGROUND– ORANGE (RETROREFLECTIVE)

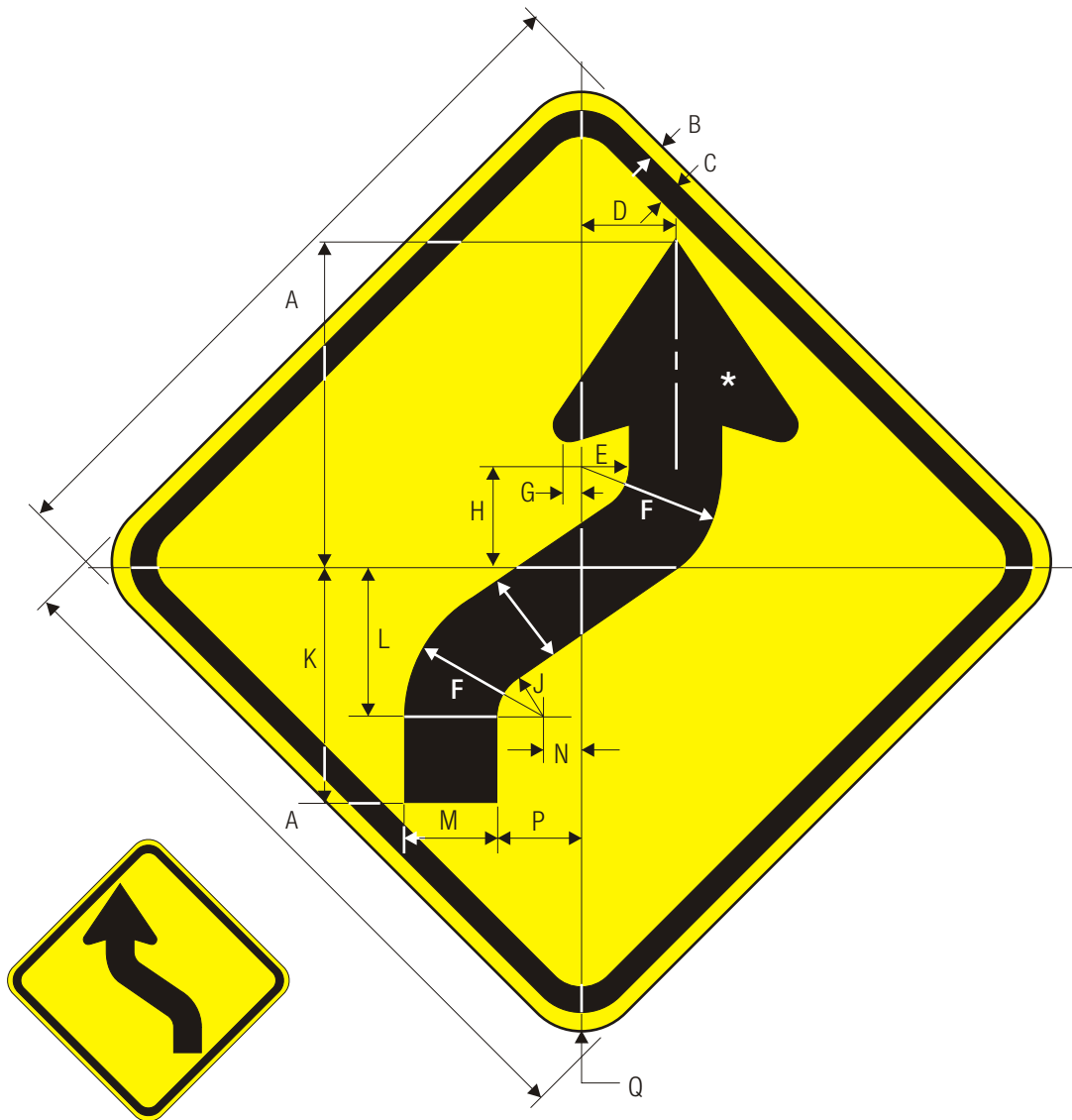

W1-4L

W1-4R

REVERSE CURVE

*See page 6-2 for symbol design.

A	B	C	D	E	F	G	H	J	K	L	M
18	.375	.625	2.375	1	3.875	.25	2.625	8.625	6.25	4	2.625
24	.375	.625	3.156	1.5	5	.313	3.5	11.25	8.25	5.25	3.5
30	.5	.75	3.938	1.875	6.25	.375	4.375	14.063	10.625	6.563	4.375
36	.625	.875	4.719	2.25	7.5	.469	5.25	16.875	12.375	7.875	5.25
48	.75	1.25	6.313	3	10	.625	7	22.5	16.5	10.5	7

N	P	Q
.875	2	1.5
1.125	2.625	1.5
1.406	3.281	1.875
1.688	3.938	2.25
2.25	5.25	3

WARNING SIGN COLORS:

SYMBOL – BLACK

BACKGROUND– YELLOW (RETROREFLECTIVE)

TTC SIGN COLORS:

SYMBOL – BLACK

BACKGROUND– ORANGE (RETROREFLECTIVE)

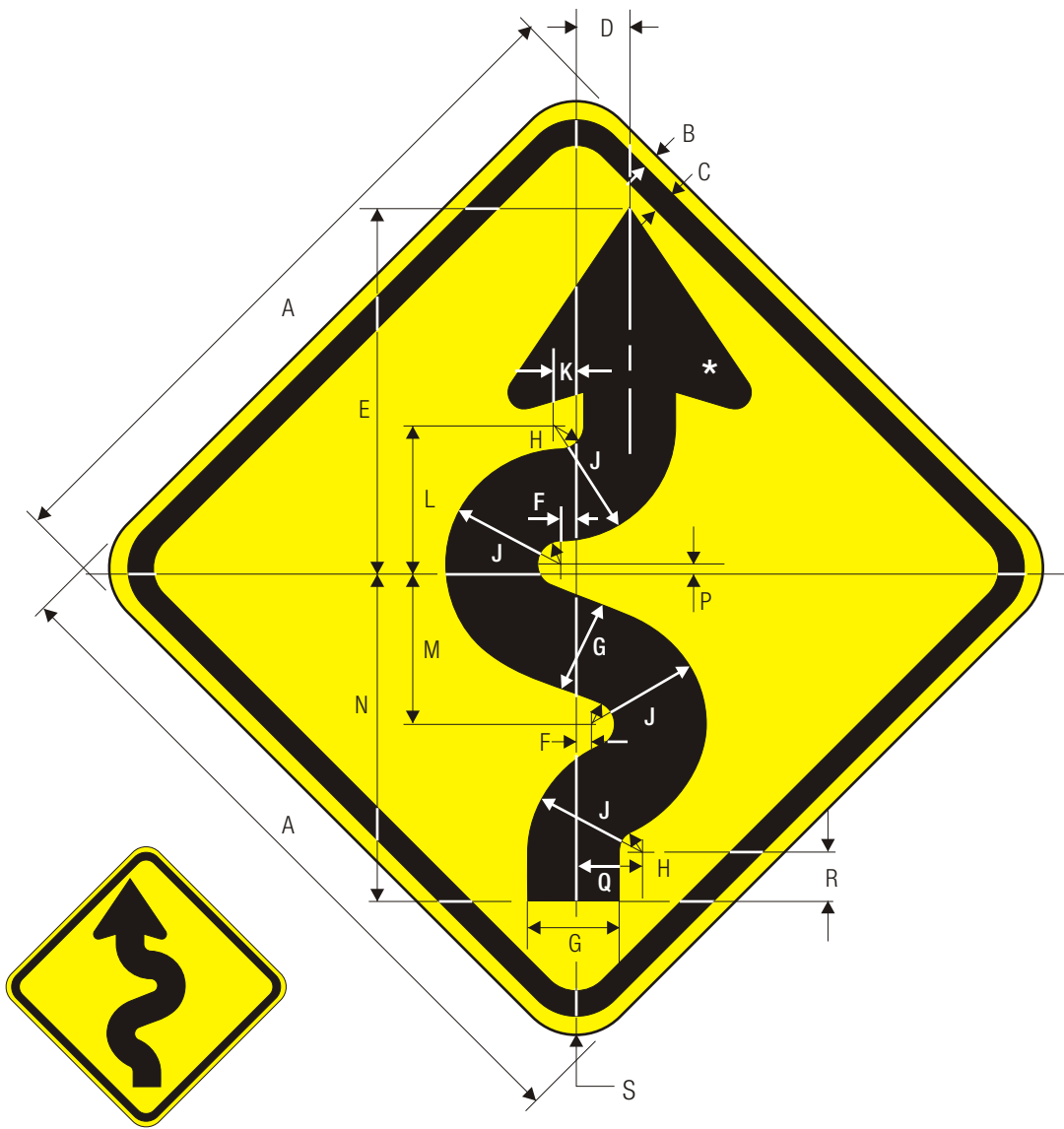

W1-5L

W1-5R
WINDING ROAD

*See page 6-2 for symbol design.

A	B	C	D	E	F	G	H	J	K	L	M
18	.375	.625	1	9.625	.375	2.5	.625	3	1	4	4
24	.375	.625	1.25	12.75	.5	3.25	.875	4.125	1.25	5.188	5.25
30	.5	.75	1.563	15.938	.625	4.063	1.094	5.156	1.563	6.484	9.563
36	.625	.875	1.875	19.125	.75	4.875	1.313	6.188	1.875	7.781	7.875
48	.75	1.25	2.5	25.5	1	6.5	1.75	8.25	2.5	10.375	10.5

N	P	Q	R	S
8.625	.25	2	1.25	1.5
11.375	.25	2.5	1.598	1.5
14.219	.313	3.125	2	1.875
17.063	.375	3.75	2.406	2.25
22.75	.5	5	3.188	3

COLORS: LEGEND – BLACK
BACKGROUND – YELLOW (RETROREFLECTIVE)

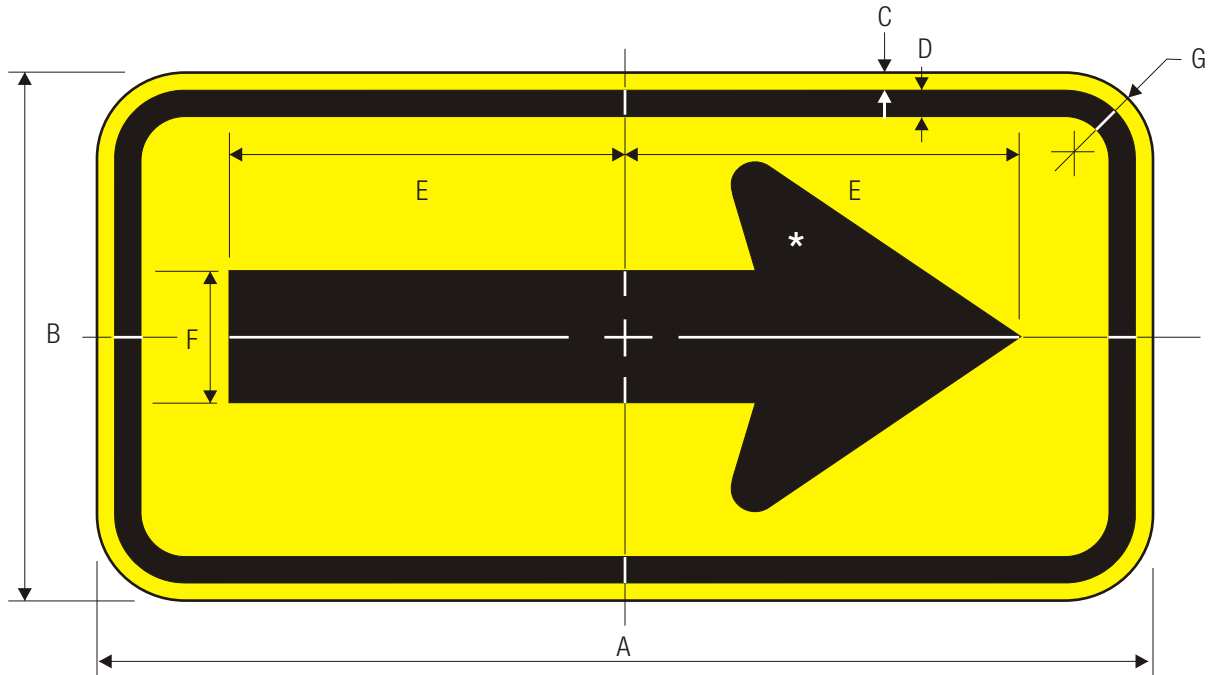

W1-6R

ONE DIRECTION LARGE ARROW



W1-6L

*See page 6-2 for symbol design.

	A	B	C	D	E	F	G
	24	12	.375	.625	9.625	3.25	1.5
	36	18	.375	.625	14.625	5	1.5
C	48	24	.5	.75	19.5	6.5	1.875
	60	30	.625	.875	24.375	8	2.25

WARNING SIGN COLORS:
 SYMBOL – BLACK
 BACKGROUND– YELLOW (RETROREFLECTIVE)

TTC SIGN COLORS:
 SYMBOL – BLACK
 BACKGROUND– ORANGE (RETROREFLECTIVE)

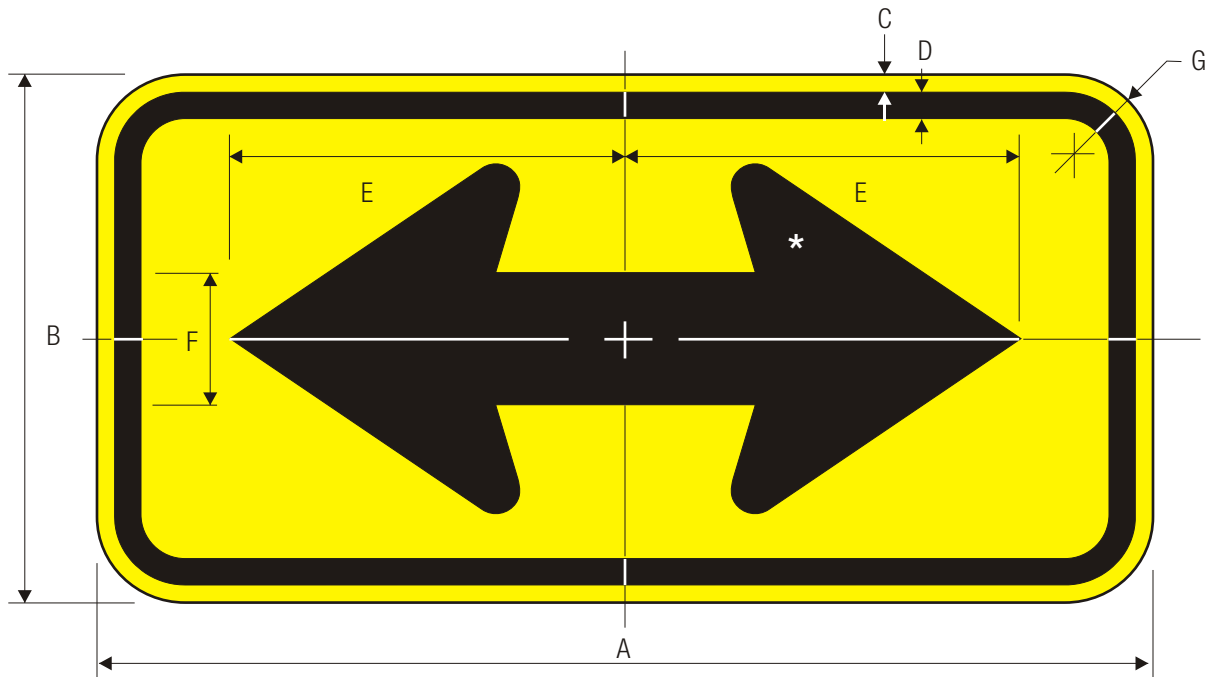

W1-7
TWO DIRECTION LARGE ARROW

*See page 6-2 for symbol design.

	A	B	C	D	E	F	G
	24	12	.375	.625	10.375	3.25	1.5
	36	18	.375	.625	15.625	5	1.5
C	48	24	.5	.75	20.5	6.5	1.875
	60	30	.625	.875	25.375	8	2.25

WARNING SIGN COLORS:
LEGEND — BLACK
BACKGROUND— YELLOW (RETROREFLECTIVE)



W1-8L

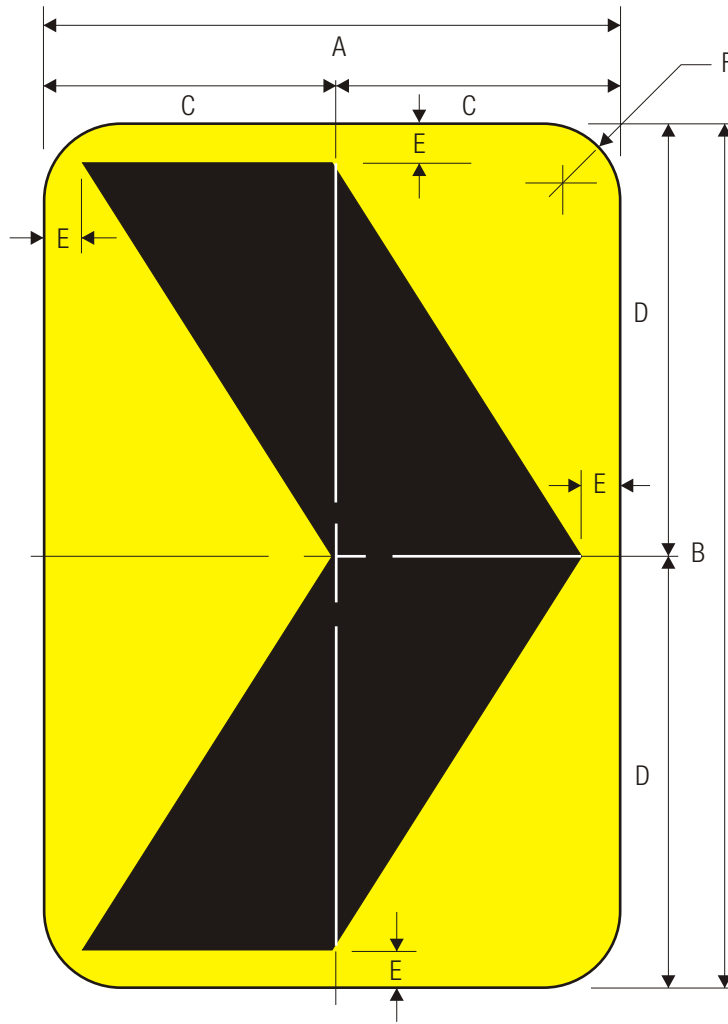

W1-8R
CHEVRON ALIGNMENT

	A	B	C	D	E	F
	12	18	6	9	.5	1.5
C	18	24	9	12	.75	1.5
	24	30	12	15	.875	1.5
	30	36	15	18	1	1.875
	36	48	18	24	1.125	2.25

WARNING SIGN COLORS:
LEGEND – BLACK
BACKGROUND– YELLOW (RETROREFLECTIVE)

TTC SIGN COLORS:
LEGEND – BLACK
BACKGROUND– ORANGE (RETROREFLECTIVE)

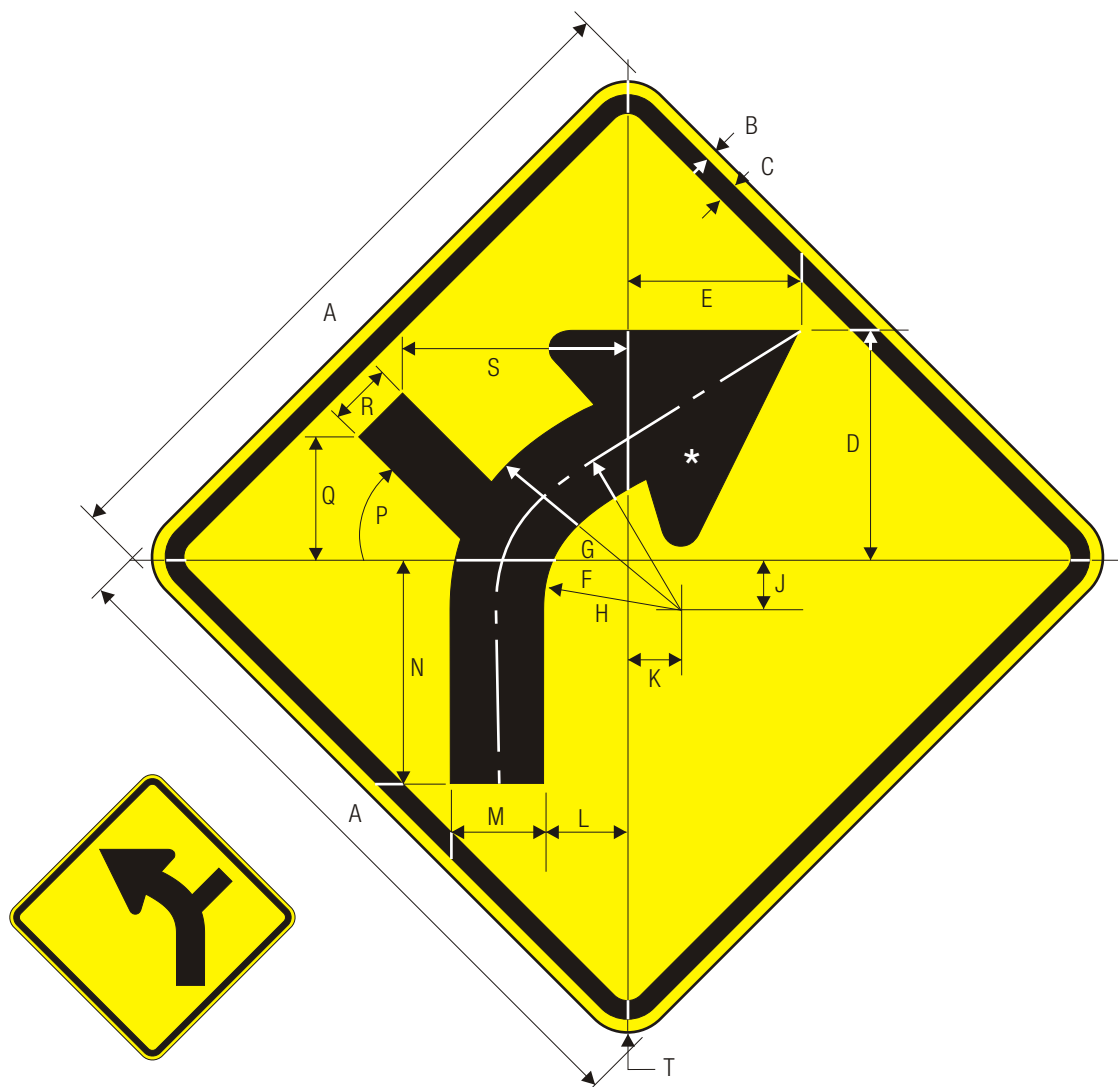

W1-10L

W1-10R

HORIZONTAL ALIGNMENT

See page 6-2 for symbol design.

A	B	C	D	E	F	G	H	J	K	L	M
18	.375	.625	5.844	4.523	5.844	4.643	3.442	1.361	1.401	2.121	2.401
24	.375	.625	7.285	5.604	7.285	5.784	4.283	1.721	1.761	2.601	3
30	.5	.75	9.727	7.525	9.807	7.805	5.804	2.241	2.321	3.482	4
36	.625	.875	12.169	9.367	12.209	9.707	7.205	2.842	2.922	4.363	5
48	.75	1.25	17	13.129	17	13.510	10	3.963	4.083	6.084	7

C

N	P	Q	R	S	T
5.844	45°	3.082	1.601	5.764	1.5
7.285	45°	4.123	2	7.685	1.5
9.727	45°	5.163	2.601	9.607	1.875
12.169	45°	6.204	3	11.528	2.25
17	45°	8.286	4	15.371	3

COLORS: LEGEND — BLACK
BACKGROUND— YELLOW (RETROREFLECTIVE)

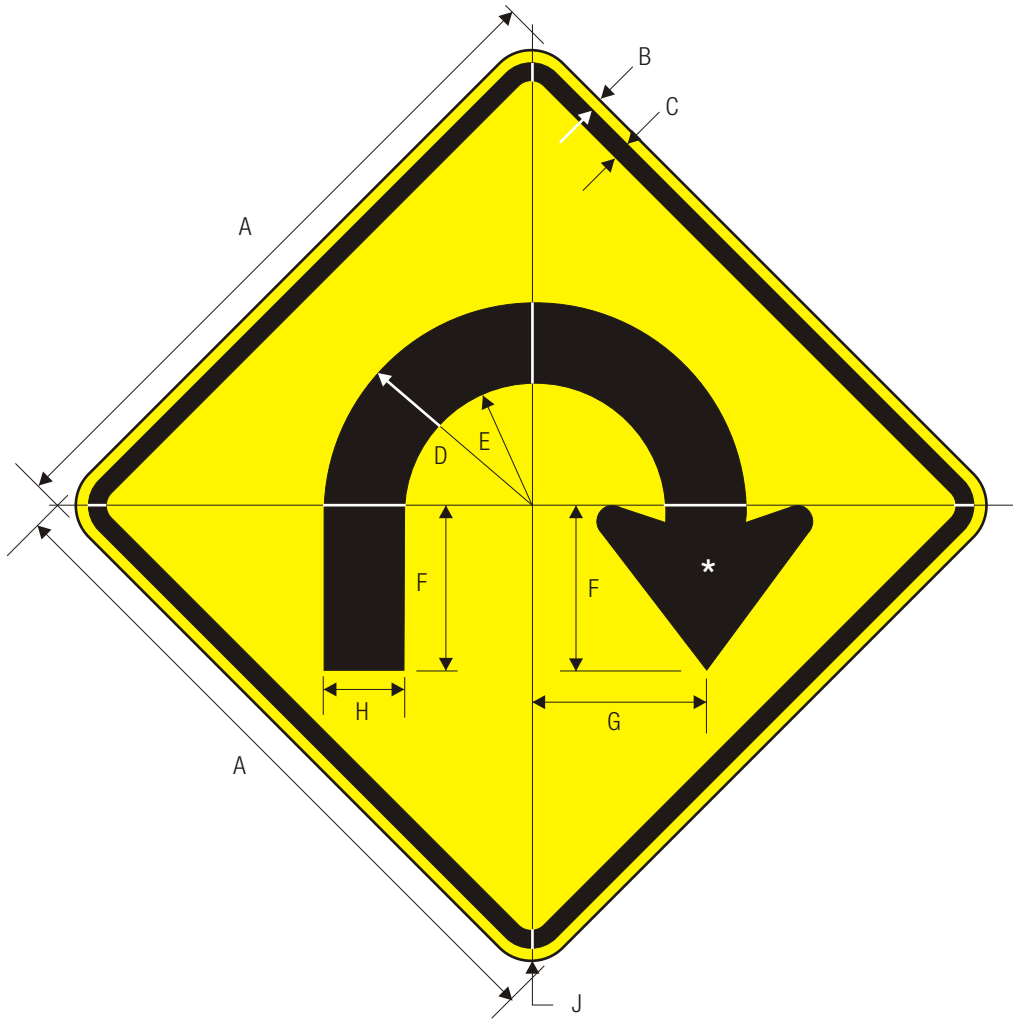

W1-11
HAIRPIN CURVE

*See page 6-2 for symbol design.
**Optically position numerals.

	A	B	C	D	E	F	G	H	J
C	30	.5	.75	9.407	5.804	7.365	7.845	3.603	1.875
	36	.625	.875	11.288	6.965	8.846	9.407	4.323	2.25
	48	.75	1.25	15.051	9.287	11.768	12.569	5.764	3

COLORS: LEGEND — BLACK
BACKGROUND— YELLOW (RETROREFLECTIVE)

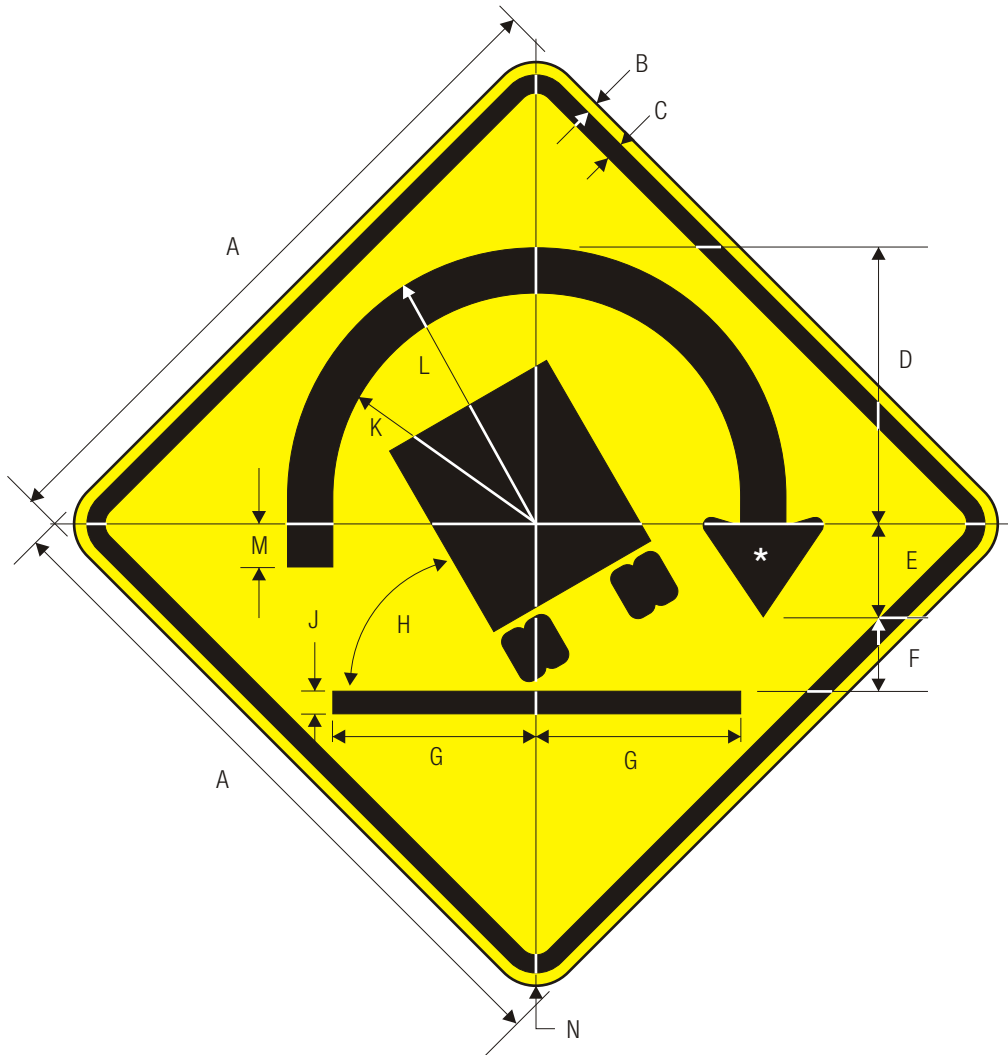

W1-13
TRUCK ROLLOVER

*See page 6-2 and 6-62 for symbol design.

	A	B	C	D	E	F	G	H	J	K	L	M	N
C	30	.5	.75	12.209	4.123	3.322	9.046	60°	.960	10.207	12.209	1.921	1.875
	36	.625	.875	14.651	4.963	4	10.848	60°	1.160	12.249	14.651	2.321	2.25
	48	.75	1.25	19.534	6.605	5.324	14.491	60°	1.521	16.332	19.534	3.082	3

COLORS: SYMBOL – BLACK
BACKGROUND– YELLOW (RETROREFLECTIVE)

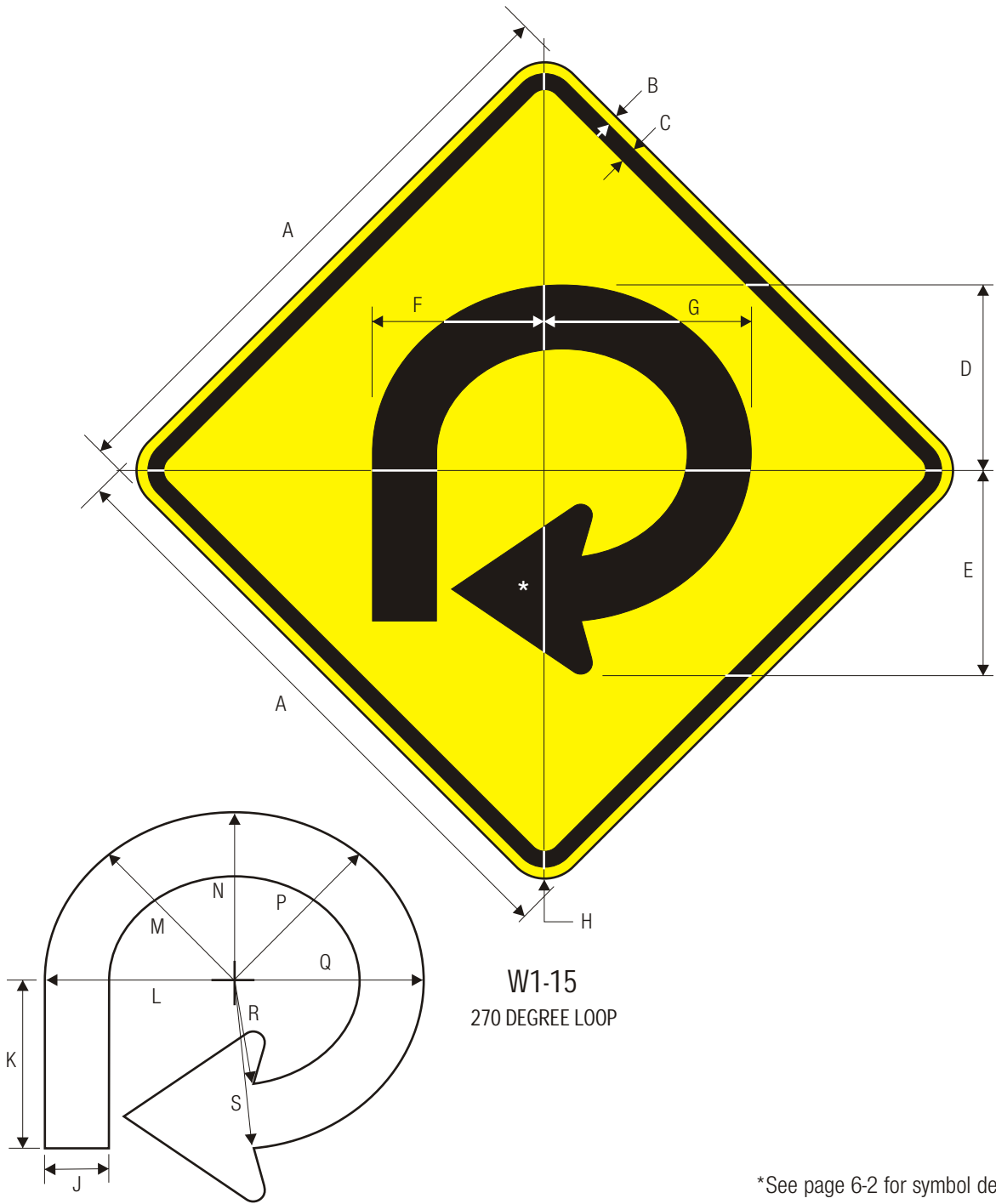

*See page 6-2 for symbol design.

C

A	B	C	D	E	F	G	H	J	K	L	M
30	.5	.75	9.287	10.167	8.606	10.327	1.875	3.202	8.406	9.447	8.966
36	.625	.875	11.128	12.209	10.327	12.409	2.25	3.842	10.087	11.328	10.768
48	.75	1.25	14.851	16.252	13.770	16.532	3	5.123	13.450	15.131	14.330

N	P	Q	R	S
8.366	8.966	9.447	5.284	8.486
10.047	10.768	11.328	6.324	10.167
13.370	14.330	15.131	8.446	13.570

COLORS: LEGEND – BLACK
BACKGROUND– YELLOW (RETROREFLECTIVE)

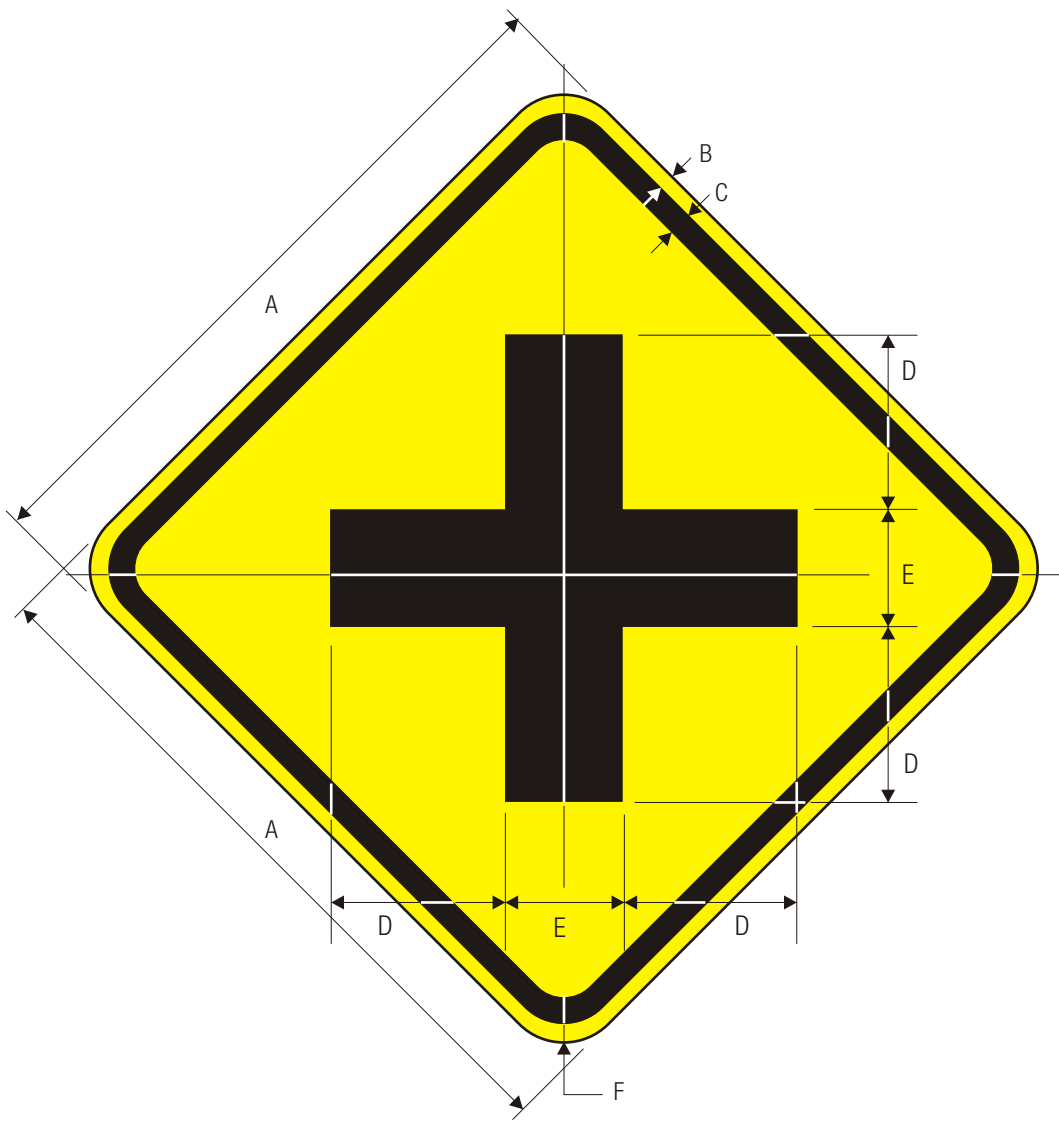

W2-1
CROSS ROAD

	A	B	C	D	E	F
	18	.375	.625	6	3	1.5
	24	.375	.625	8	4	1.5
C	30	.5	.75	10	5	1.875
	36	.625	.875	12	6	2.25
	48	.75	1.25	16	8	3

COLORS: LEGEND — BLACK
BACKGROUND— YELLOW (RETROREFLECTIVE)

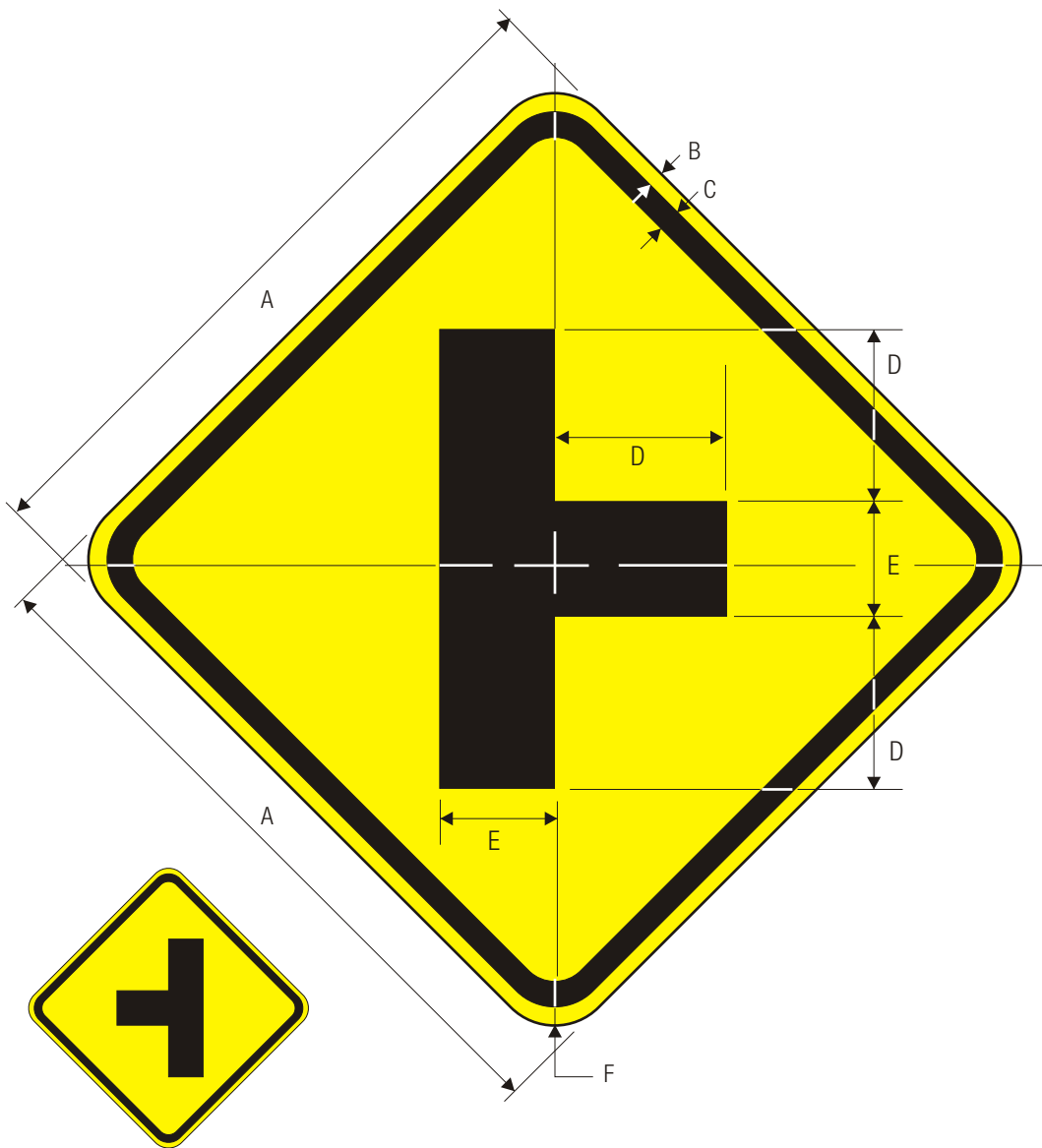

W2-2L

W2-2R
SIDE ROAD

C

A	B	C	D	E	F
18	.375	.625	6	3	1.5
24	.375	.625	8	4	1.5
30	.5	.75	10	5	1.875
36	.625	.875	12	6	2.25
48	.75	1.25	16	8	3

COLORS: LEGEND — BLACK
BACKGROUND— YELLOW (RETROREFLECTIVE)

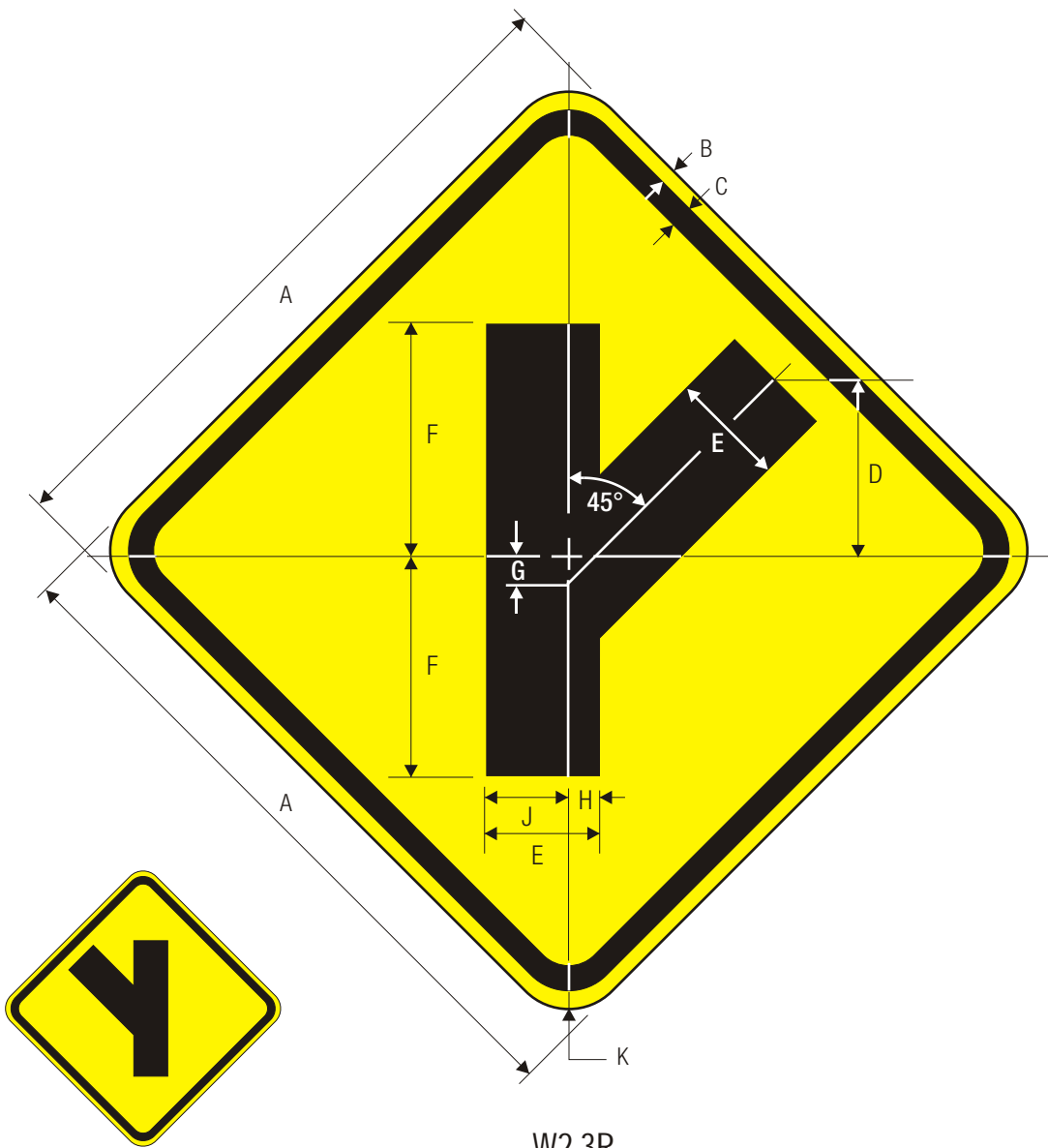

W2-3L

W2-3R
SIDE ROAD

C

A	B	C	D	E	F	G	H	J	K
18	.375	.625	5	3	7.75	.375	.75	2.25	1.5
24	.375	.625	6.656	4	10	.563	1	3	1.5
30	.5	.75	8.313	5	12.5	.688	1.25	3.75	1.875
36	.625	.875	10	6	15	.844	1.5	4.5	2.25
48	.75	1.25	13.313	8	20	1.125	2	6	3

COLORS: LEGEND — BLACK
BACKGROUND— YELLOW (RETROREFLECTIVE)

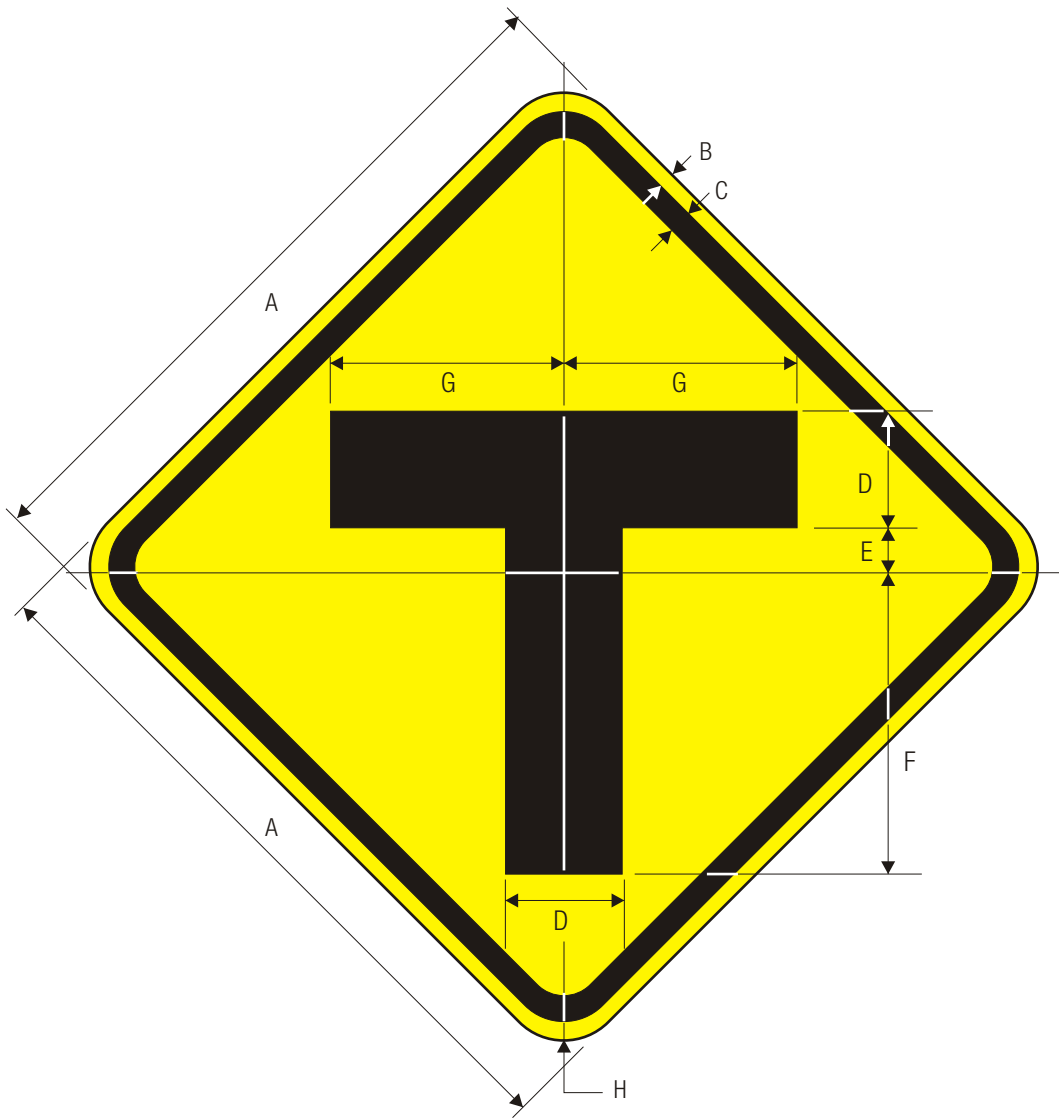

W2-4

T-SYMBOL

	A	B	C	D	E	F	G	H
	18	.375	.625	3	1.25	8.375	6.375	1.5
	24	.375	.625	4	1.5	11	8.5	1.5
C	30	.5	.75	5	1.875	13.75	10.625	1.875
	36	.625	.875	6	2.25	16.5	12.75	2.25
	48	.75	1.25	8	3	22	17	3

COLORS: LEGEND — BLACK
 BACKGROUND— YELLOW (RETROREFLECTIVE)

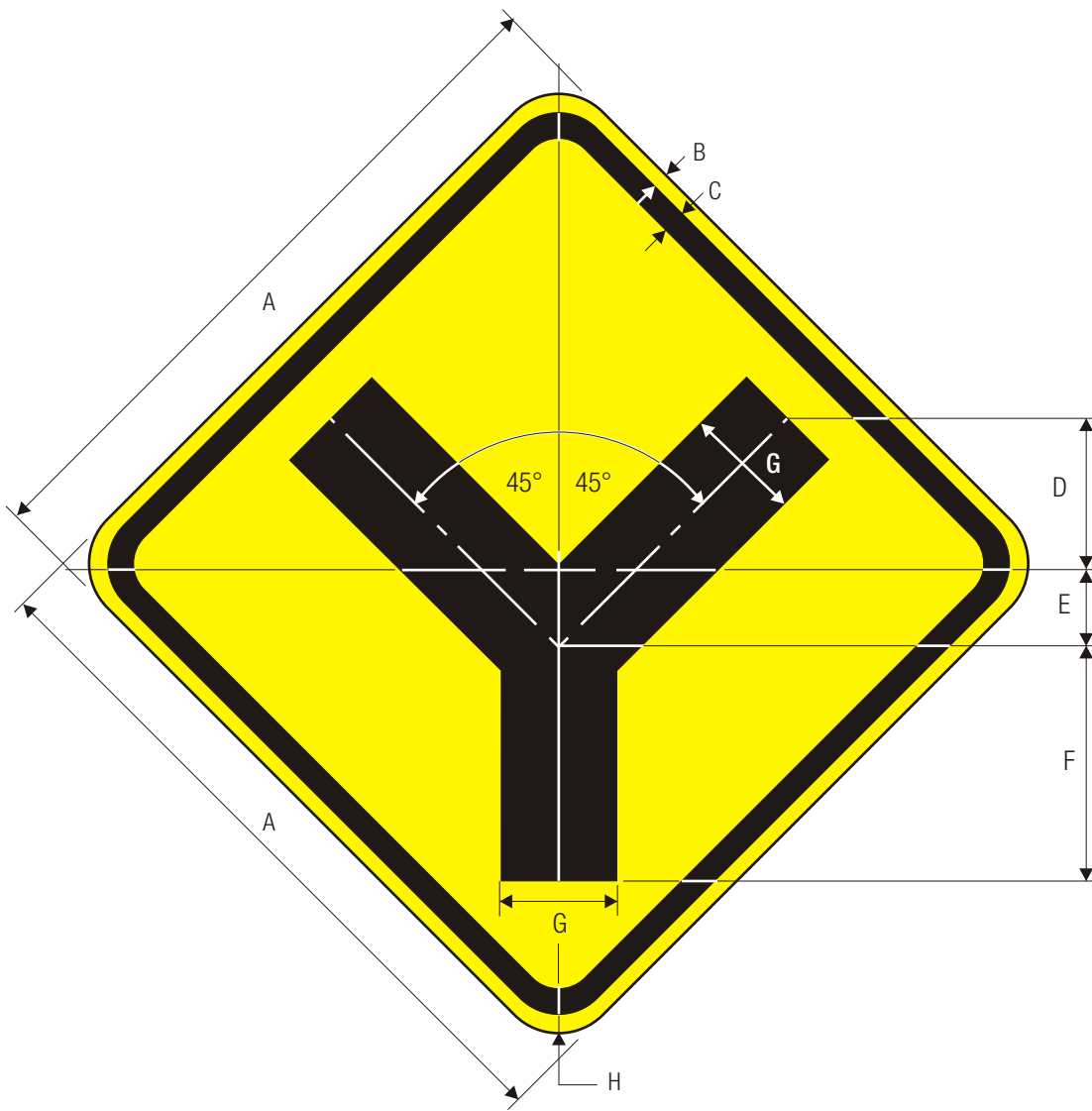

W2-5
Y-SYMBOL

	A	B	C	D	E	F	G	H
	18	.375	.625	4.5	1.75	6.75	3	1.5
	24	.375	.625	5.906	2.406	9.094	4	1.5
C	30	.5	.75	7.375	3	11.375	5	1.875
	36	.625	.875	8.844	3.594	13.656	6	2.25
	48	.75	1.25	11.813	4.813	18.188	8	3

COLORS: LEGEND — BLACK
BACKGROUND— YELLOW (RETROREFLECTIVE)

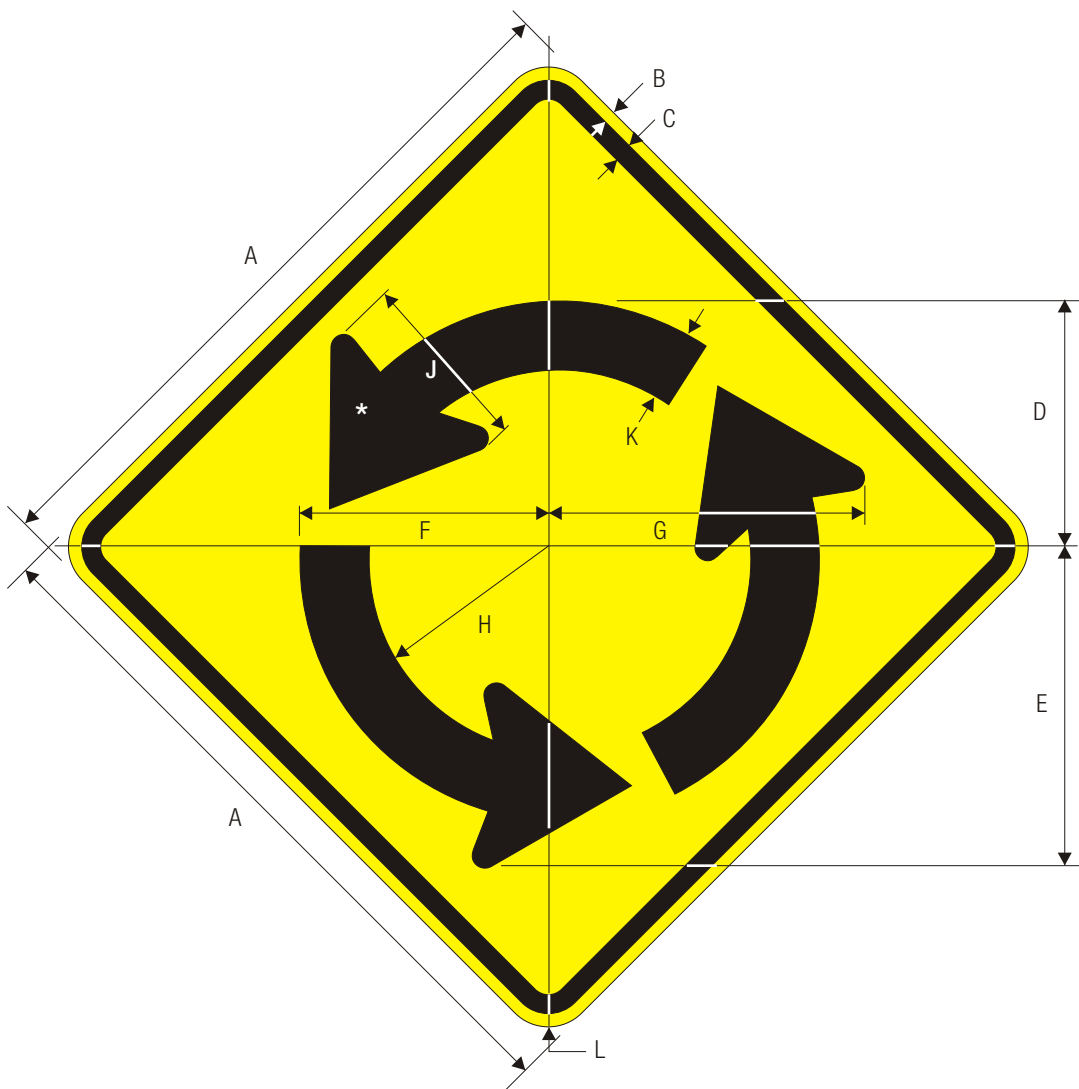

W2-6
CIRCULAR INTERSECTION

*See page 6-36 for symbol design.

A	B	C	D	E	F	G	H	J	K	L
24	.375	.625	8.406	10.808	8.406	10.848	6.028	6.18	2.378	1.5
30	.5	.75	10.487	13.490	10.487	13.570	7.549	7.725	2.938	1.875
36	.625	.875	12.569	16.172	12.569	16.292	9.043	9.27	3.526	2.25
48	.75	1.25	16.812	21.616	16.812	21.696	12.056	12.36	4.756	3

COLORS: SYMBOL – BLACK
BACKGROUND– YELLOW (RETROREFLECTIVE)

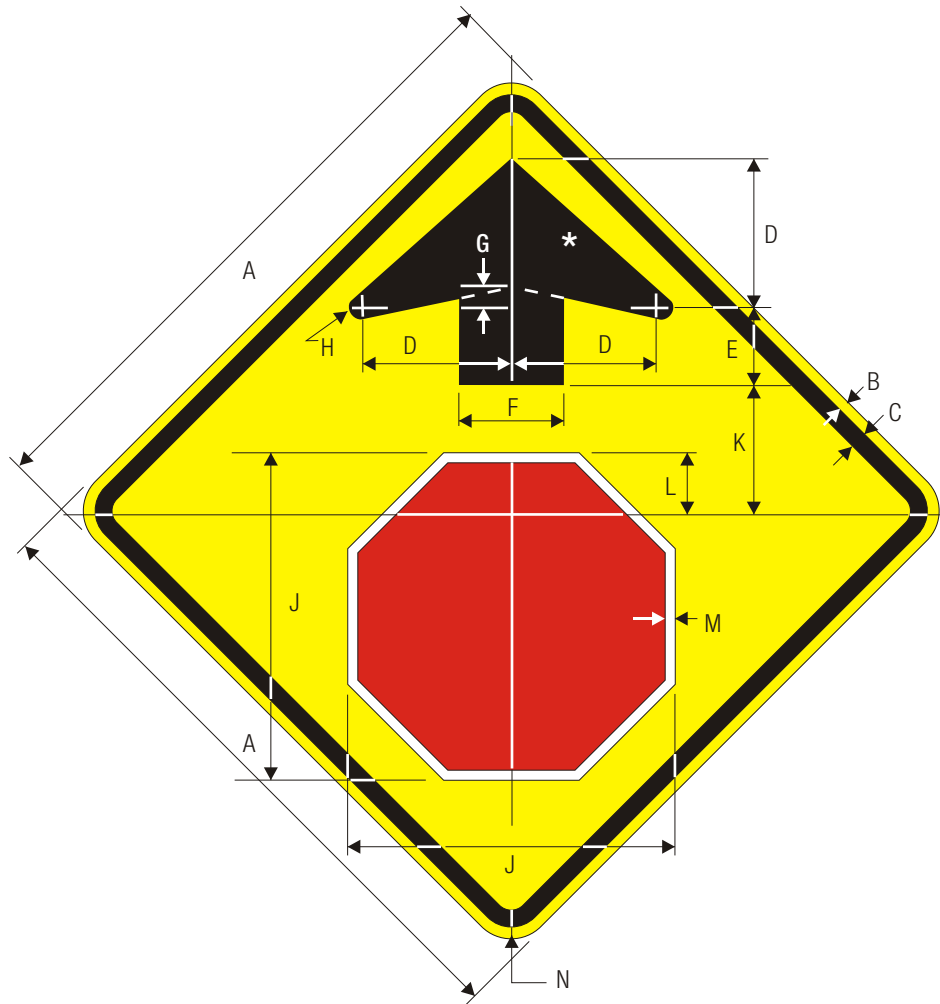

W3-1

STOP AHEAD

*See page 6-3 for symbol design.

A	B	C	D	E	F	G	H	J	K	L	M	N
18	.375	.625	4.5	2.25	3	.375	.187	9.5	3	1.75	.313	1.5
24	.375	.625	6	3	4	.5	.25	12.562	5	2.25	.375	1.5
30	.5	.75	7.5	3.75	5	.625	.313	15.75	6.25	2.875	.5	1.875
36	.625	.875	9	4.5	6	.75	.375	19	7.5	3.5	.625	2.25
48	.75	1.25	12	6	8	1	.5	25.125	10	4.5	.75	3

WARNING SIGN COLORS:

BORDER & ARROW – BLACK

SYMBOL – WHITE BORDER / RED BACKGROUND (RETROREFLECTIVE)

BACKGROUND – YELLOW (RETROREFLECTIVE)

TTC COLORS:

BORDER & ARROW – BLACK

SYMBOL – WHITE BORDER / RED BACKGROUND (RETROREFLECTIVE)

BACKGROUND – ORANGE (RETROREFLECTIVE)

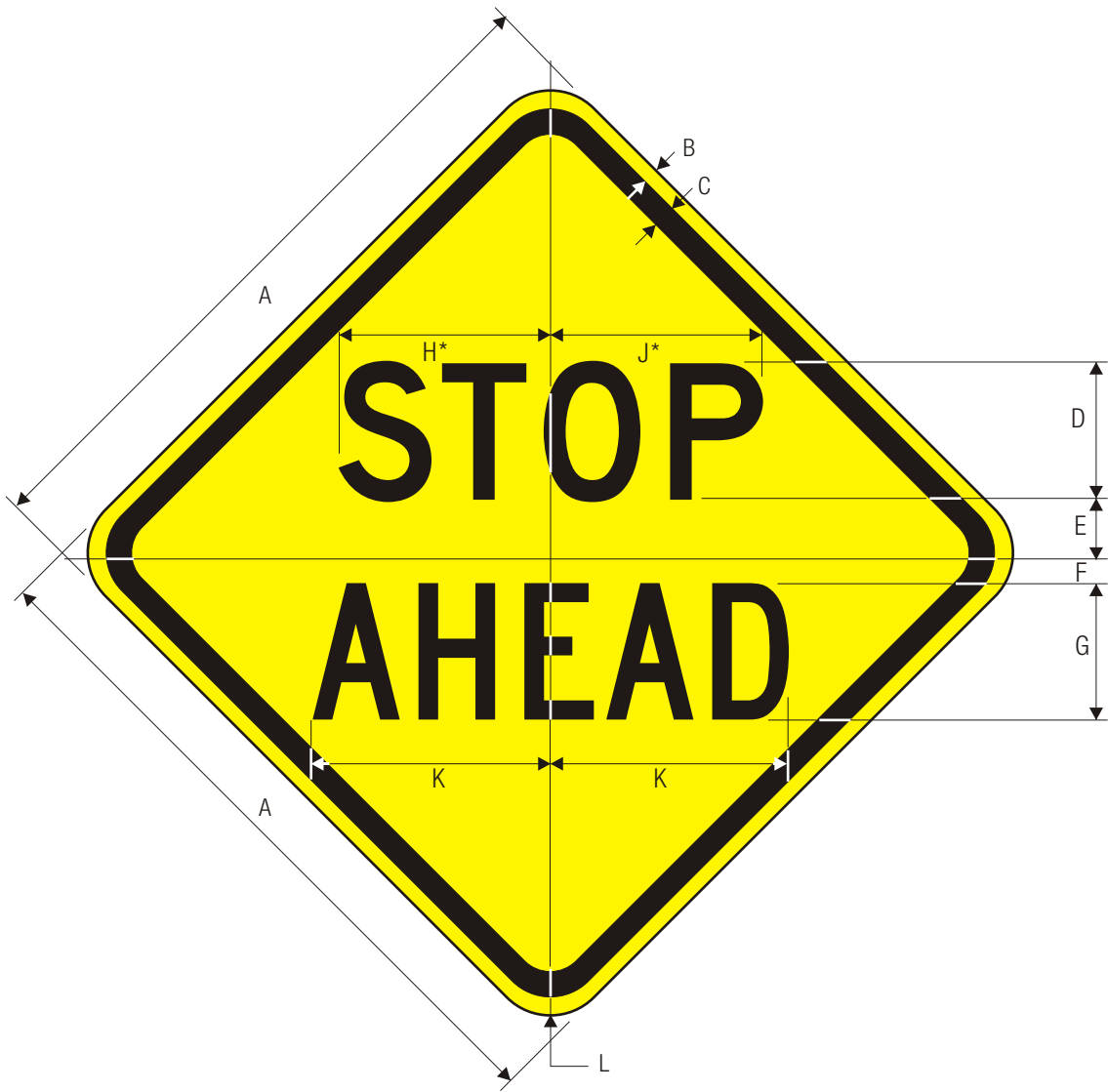

W3-1a
STOP AHEAD

*Reduce spacing 20%; no reduction for 18 and 24" size.

A	B	C	D	E	F	G	H	J	K	L
18	.375	.625	3 D	1.75	.75	3 C	4.75	5.25	5.375	1.5
24	.375	.625	5 D	2	1	5 C	8.125	8.188	8.75	1.5
30	.5	.75	6 D	2.5	1.25	6 C	9	9.875	10.5	1.875
C 36	.625	.875	7 D	3	1.5	7 C	10.5	11.563	12.25	2.25
48	.75	1.25	9 D	4	2	9 C	13.5	14.813	15.75	3

COLORS: LEGEND — BLACK
BACKGROUND— YELLOW (RETROREFLECTIVE)

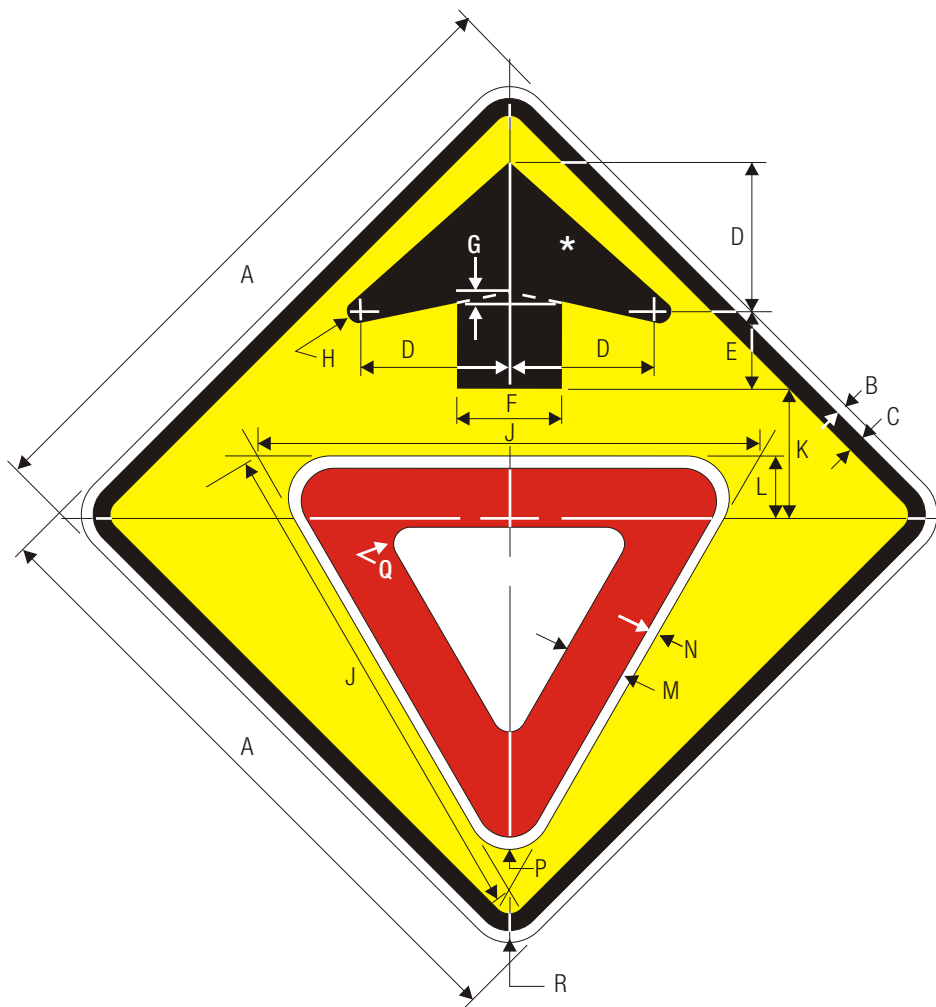

W3-2
YIELD AHEAD

*See page 6-3 for symbol design.

A	B	C	D	E	F	G	H	J	K	L	M	N
18	.375	.625	4.5	2.25	3	.375	.187	14	3	1.687	1.875	.313
24	.375	.625	6	3	4	.5	.25	19	5	2.25	2.5	.375
30	.5	.75	7.5	3.75	5	.625	.313	25	6.25	3	3.375	.5
36	.625	.875	9	4.5	6	.75	.375	28	7.5	3.375	3.75	.625
48	.75	1.25	12	6	8	1	.5	38	10	4.5	5	.75

C

P	Q	R
.687	.375	1.5
.937	.5	1.5
1.25	.625	1.875
1.375	.75	2.25
1.875	1	3

WARNING SIGN COLORS:

BORDER & ARROW – BLACK

SYMBOL – WHITE BORDER / RED BACKGROUND (RETROREFLECTIVE)

BACKGROUND – YELLOW (RETROREFLECTIVE)

TTC COLORS:

BORDER & ARROW – BLACK

SYMBOL – WHITE BORDER / RED BACKGROUND (RETROREFLECTIVE)

BACKGROUND – ORANGE (RETROREFLECTIVE)

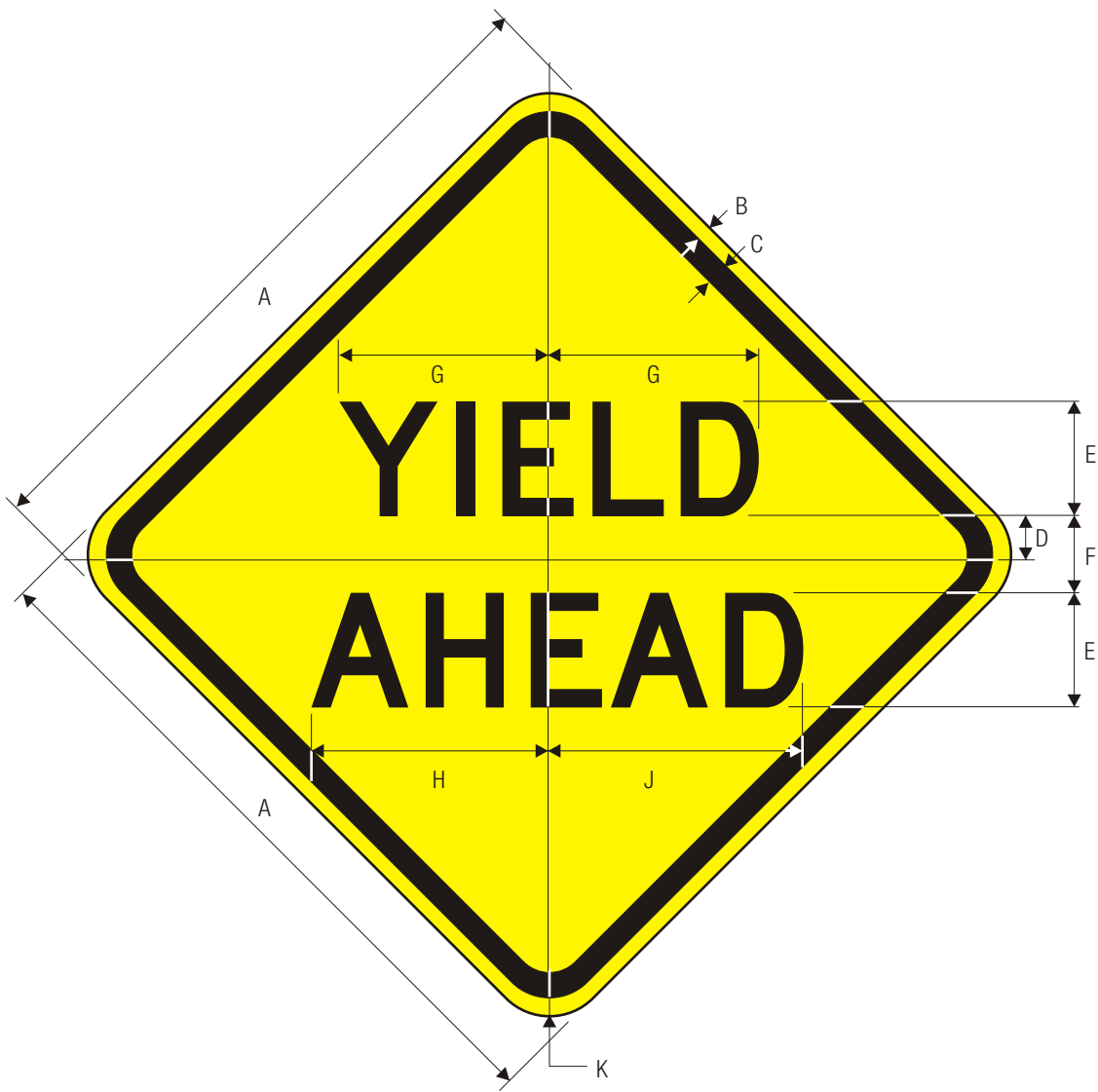

W3-2a

YIELD AHEAD

	A	B	C	D	E	F	G	H	J	K
	18	.375	.625	1	3 D	2	5.484	6.244	6.605	1.5
	24	.375	.625	1.375	4 D	2.688	7.307	8.349	8.791	1.5
	30	.5	.75	1.681	5 D	3.362	9.146	10.407	11.168	1.875
C	36	.625	.875	2	6 D	4	10.968	12.489	13.210	2.25
	48	.75	1.25	2.682	8 D	5.364	14.631	16.652	17.652	3

COLORS: LEGEND — BLACK
 BACKGROUND — YELLOW (RETROREFLECTIVE)

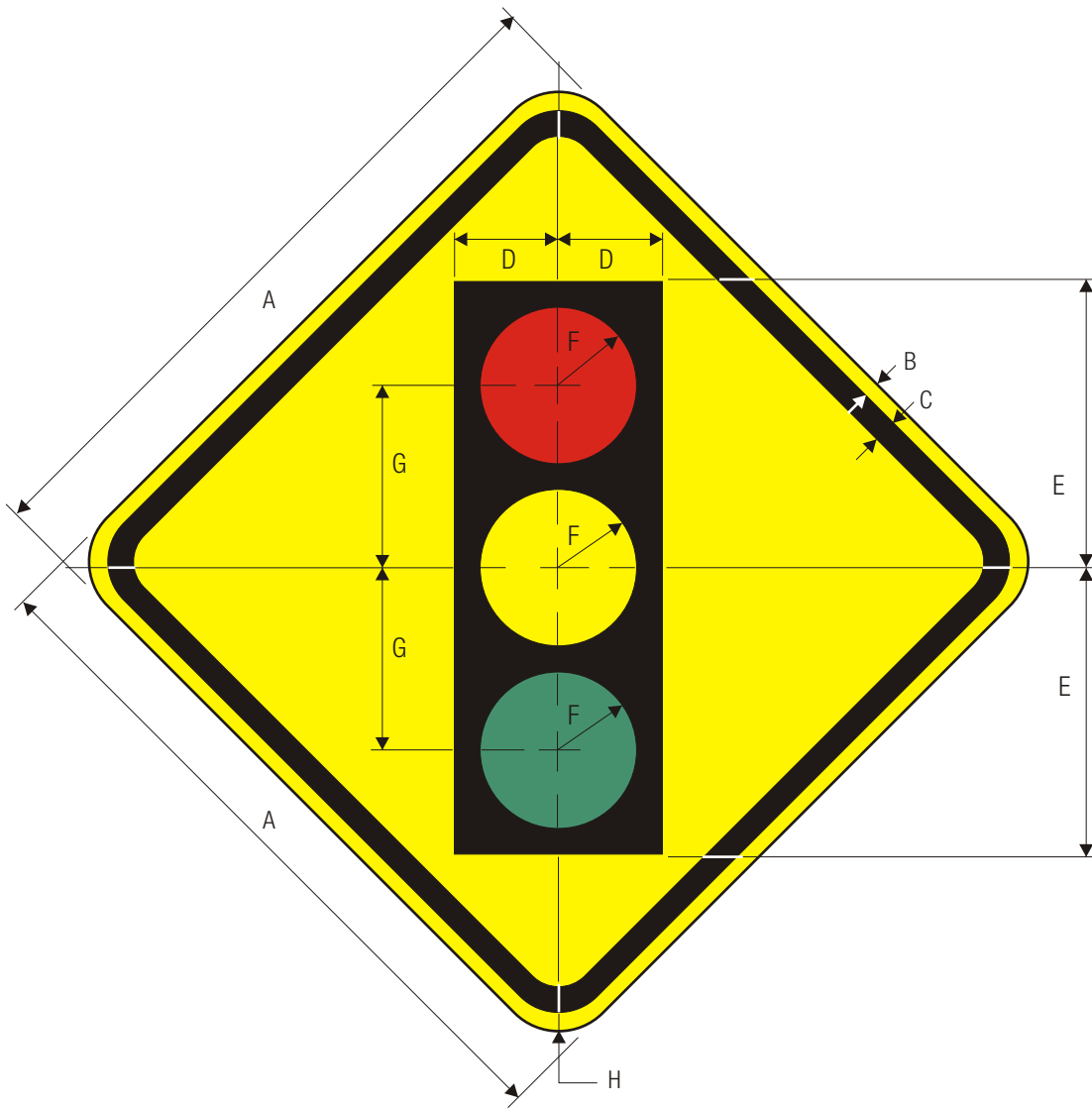

W3-3
SIGNAL AHEAD

A	B	C	D	E	F	G	H
18	.375	.625	3	8	2.25	5	1.5
30	.5	.75	5	13.75	3.75	8.75	1.875
36	.625	.875	5.75	15.75	4.25	10	2.25
48	.75	1.25	7.5	20	5	12.5	3

WARNING SIGN COLORS:
 TOP CIRCLE — RED (RETROREFLECTIVE)
 BOTTOM CIRCLE — GREEN (RETROREFLECTIVE)
 BACKGROUND — YELLOW (RETROREFLECTIVE)

TTC SIGN COLORS:
 TOP CIRCLE — RED (RETROREFLECTIVE)
 BOTTOM CIRCLE — GREEN (RETROREFLECTIVE)
 BACKGROUND — ORANGE (RETROREFLECTIVE)

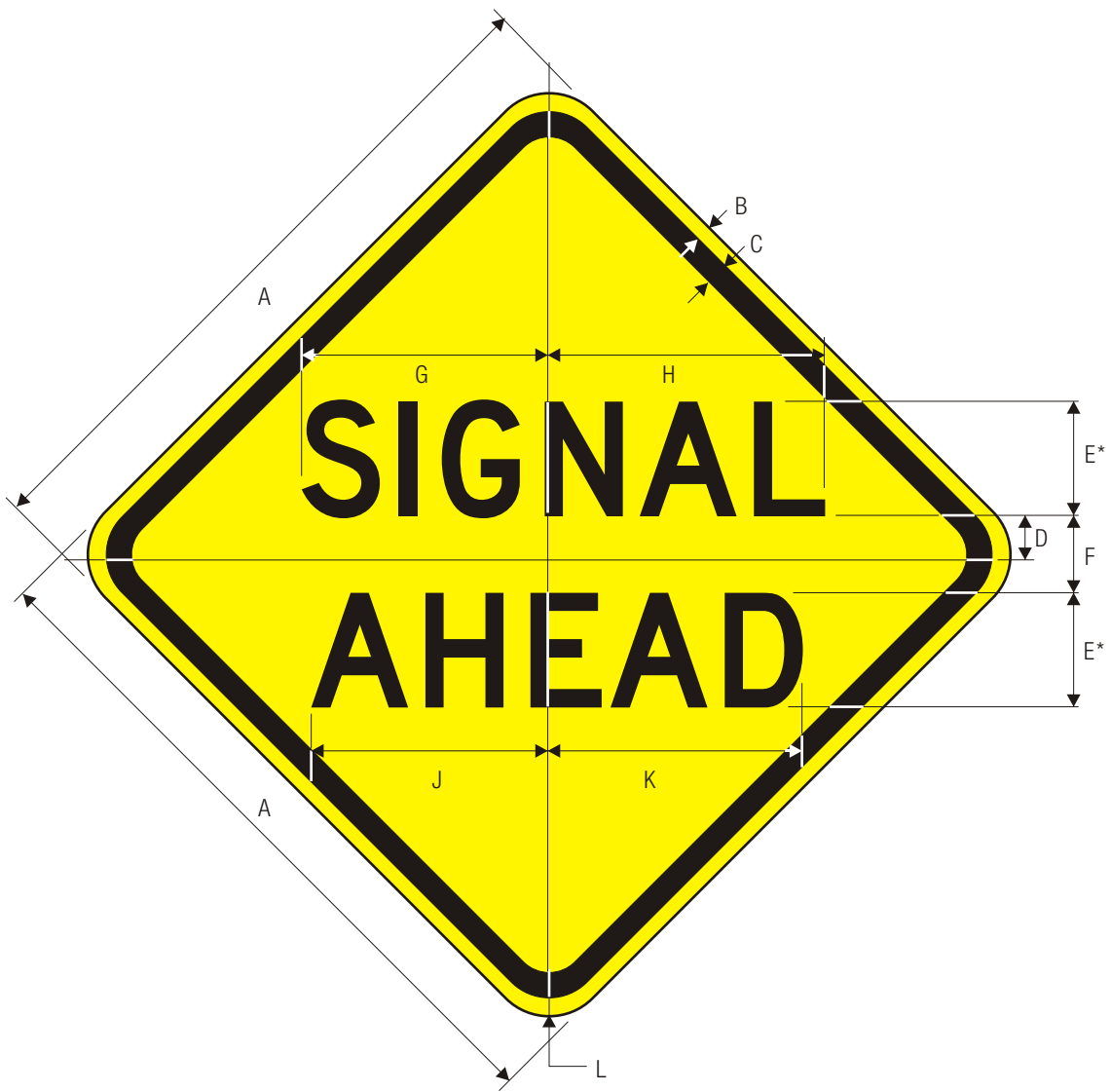

W3-3a
SIGNAL AHEAD

*Series 2000 Standard Alphabets.

A	B	C	D	E	F	G	H	J	K	L
18	.375	.625	1	3 D	2	6.484	7.205	6.244	6.605	1.5
30	.5	.75	1.681	5 D	3.362	10.808	12	10.407	11.168	1.875
36	.625	.875	2	6 D	4	12.969	14.410	12.489	13.210	2.25
48	.75	1.25	2.682	8 D	5.364	17.293	19.214	16.652	17.652	3

C

COLORS: LEGEND — BLACK
BACKGROUND — YELLOW (RETROREFLECTIVE)



W3-4

BE PREPARED TO STOP

*Series 2000 Standard Alphabets.

A	B	C	D	E	F	G	H	J	K	L
30	.5	.75	5 C	2.702	.700	3.086	13.650	10.833	11.593	1.875
36	.625	.875	6 C	3.602	.920	3.702	16.392	13.089	13.850	2.25
48	.75	1.25	8 C	4.803	1.200	4.943	21.856	17.413	18.494	3
60	.75	1.25	9 C	5.404	1.401	5.564	24.578	19.454	20.195	3

C

WARNING SIGN COLORS:

LEGEND — BLACK
BACKGROUND — YELLOW (RETROREFLECTIVE)

TTC SIGN COLORS:

LEGEND — BLACK
BACKGROUND — ORANGE (RETROREFLECTIVE)

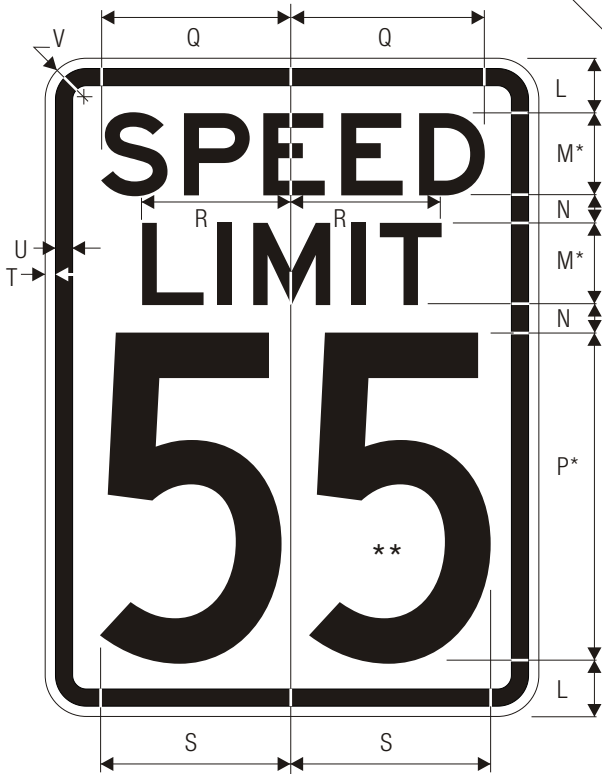
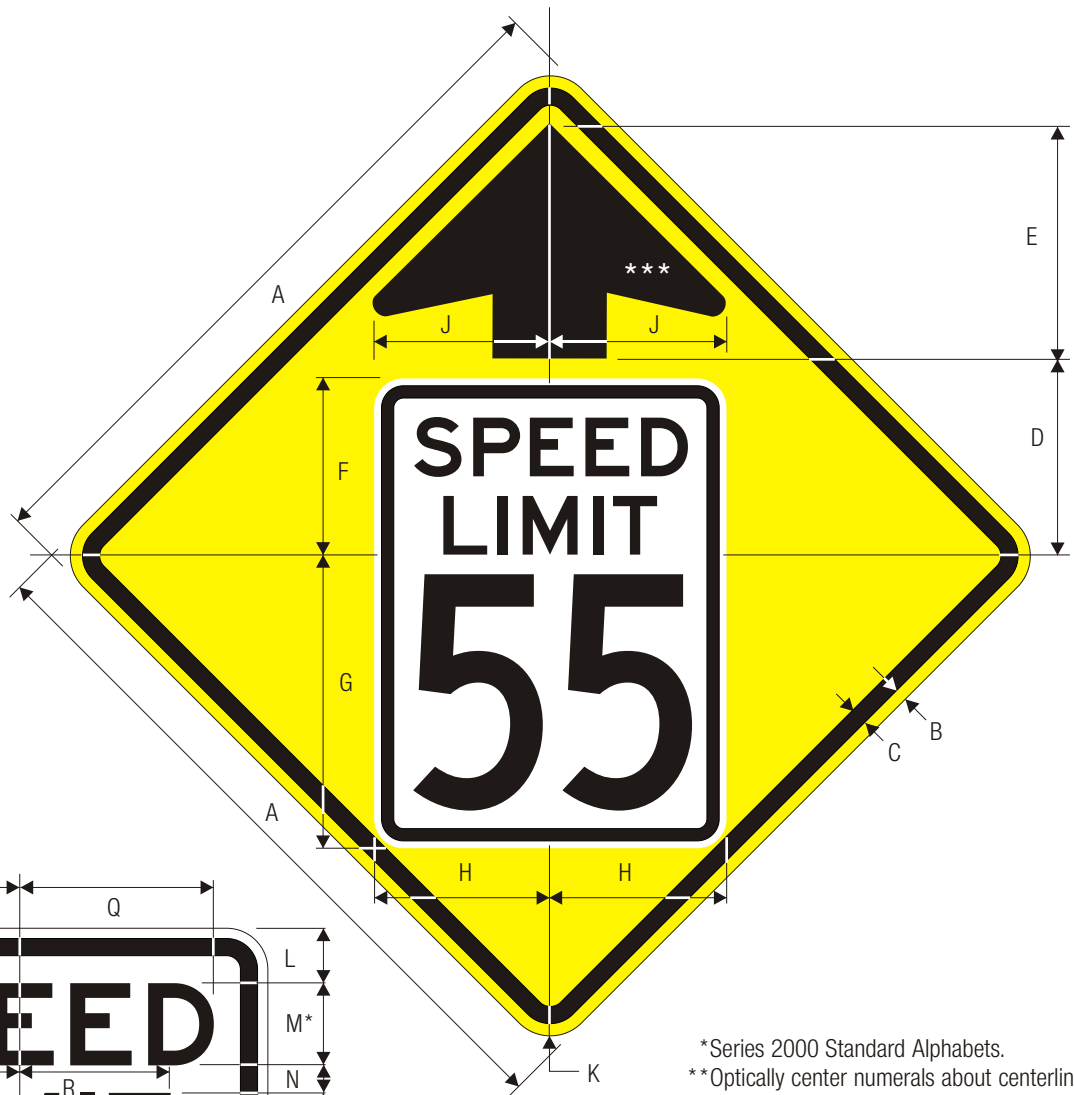

W3-5
SPEED REDUCTION

*Series 2000 Standard Alphabets.
**Optically center numerals about centerline.
***See page 6-3 for symbol design.

	A	B	C	D	E	F	G
C	36	.625	.875	10	12	9	15
	48	.75	1.25	11.75	18	10.75	19.25
	H	J	K	L	M	N	P
	9	9	2.25	2	3 E	1	12 C
	12	12	3	2.25	4 E	1.25	15 C
	Q	R	S	T	U	V	
	7	5.46	7.126	.375	.625	2.25	
	9.327	7.279	9.258	.375	.625	3	

WARNING SIGN COLORS:

- BORDER & ARROW – BLACK
- SYMBOL – SEE R2-1
- BACKGROUND – YELLOW (RETROREFLECTIVE)

TTC COLORS:

- BORDER & ARROW – BLACK
- SYMBOL – SEE R2-1
- BACKGROUND – ORANGE (RETROREFLECTIVE)

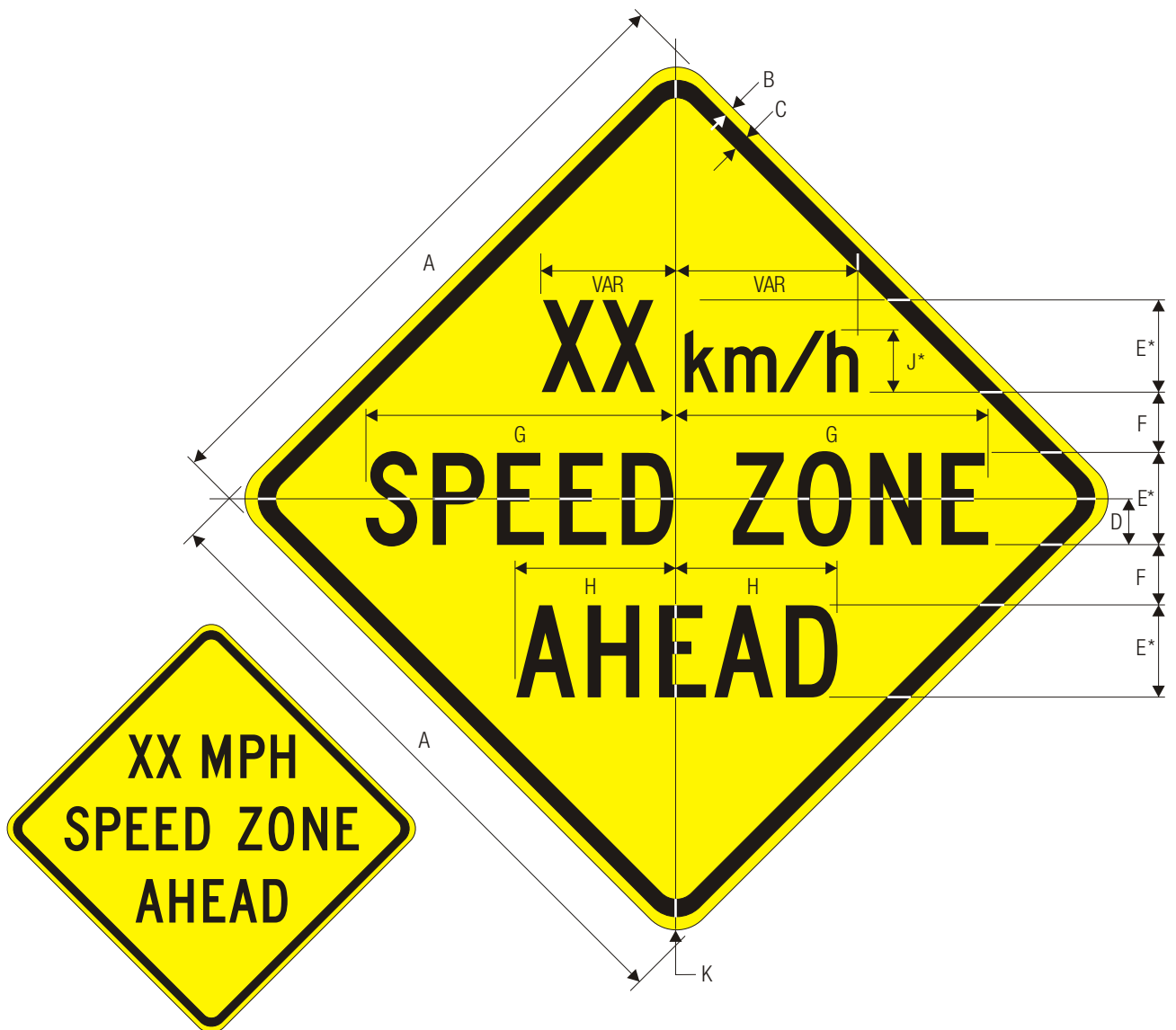

W3-5a
SPEED REDUCTION (ENGLISH)

W3-5a
SPEED REDUCTION (METRIC)

*Series 2000 Standard Alphabets.

	A	B	C	D	E	F	G	H	J	K
	30	.5	.75	2	4 C	3	13.5	6.985	2.7 C	1.875
C	36	.625	.875	2.5	5 C	3.625	16.892	8.726	3.4 C	2.25
	48	.75	1.25	3.5	7 C	4.625	23.657	12.209	4.7 C	3
	60	.75	1.25	4	8 C	6	27.019	13.944	5.4 C	3

WARNING SIGN COLORS:
LEGEND — BLACK
BACKGROUND— YELLOW (RETROREFLECTIVE)

TTC SIGN COLORS:
LEGEND — BLACK
BACKGROUND— ORANGE (RETROREFLECTIVE)

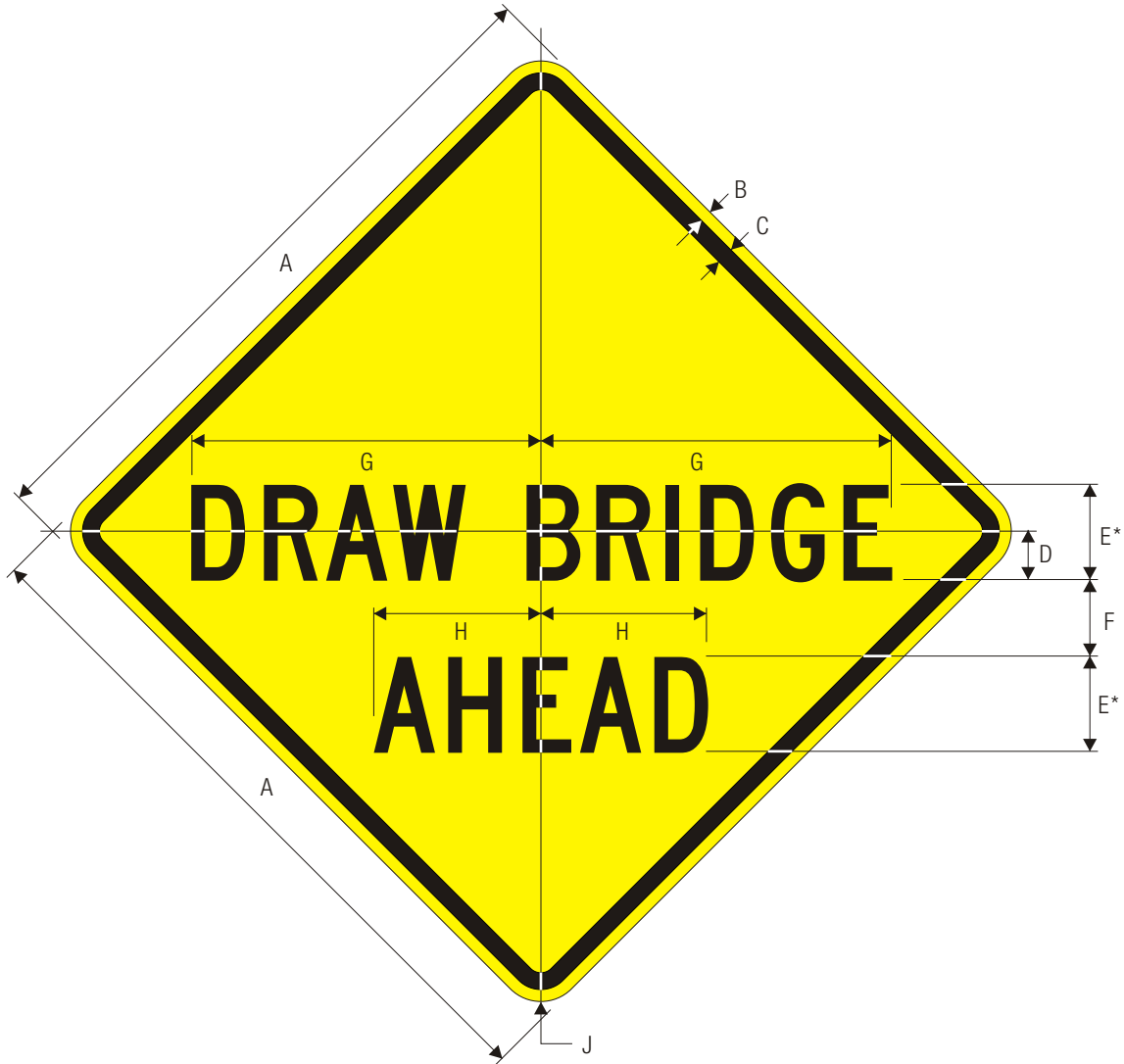

W3-6
DRAW BRIDGE AHEAD

*Series 2000 Standard Alphabets.

	A	B	C	D	E	F	G	H	J
C	36	.625	.875	2.5	5 C	4	18.269	8.713	2.25
	48	.75	1.25	3.5	7 C	6	25.575	12.198	3
	60	.75	1.25	4.5	9 C	8	32.891	15.688	3

COLORS: LEGEND — BLACK
BACKGROUND — YELLOW (RETROREFLECTIVE)

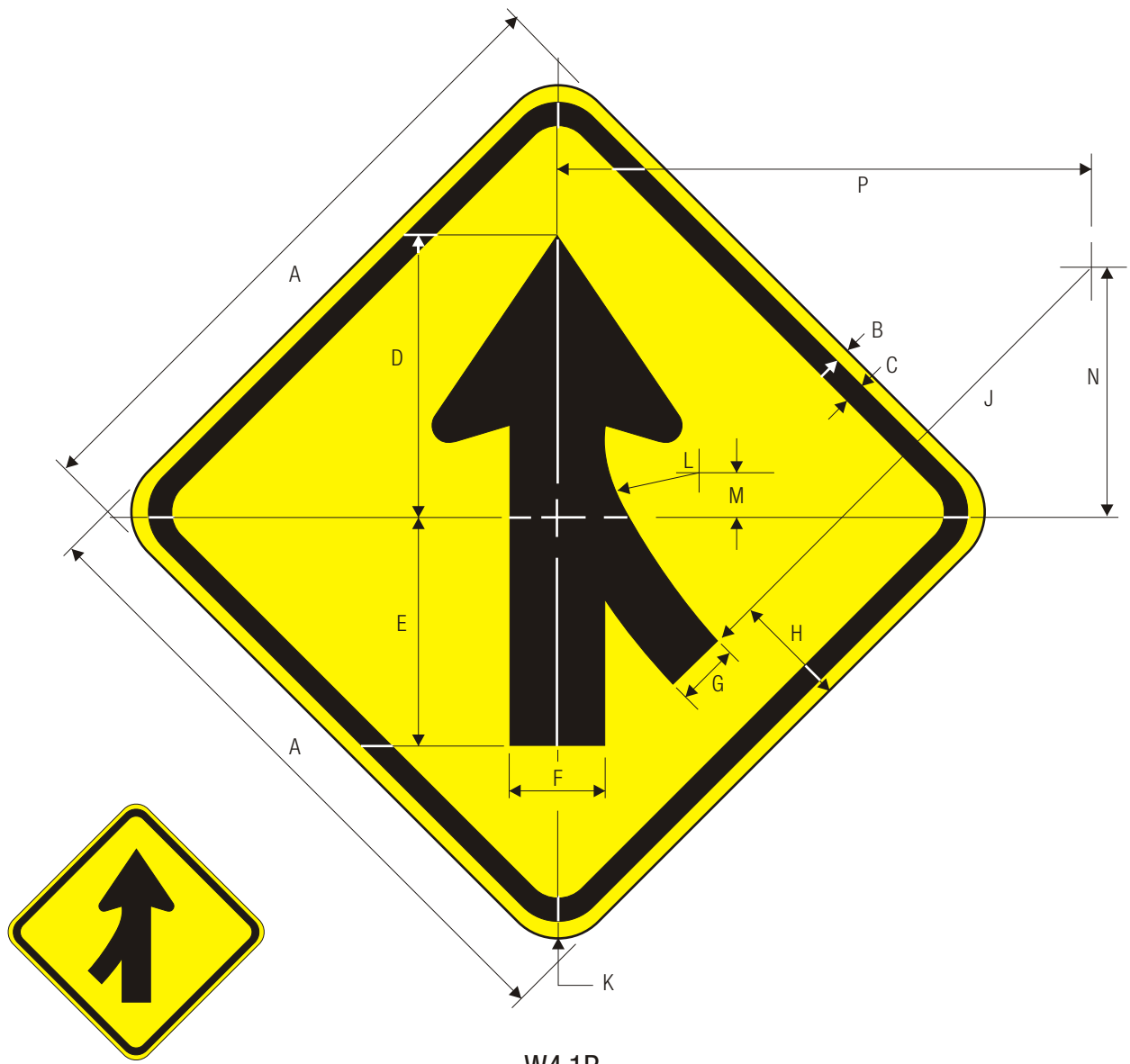

W4-1L

W4-1R
MERGE

*See page 6-2 for arrow design.

A	B	C	D	E	F	G	H	J	K	L	M	N	P
24	.375	.625	10.25	8.75	3.5	2.375	4.188	22.25	1.5	6.375	2.625	10.375	22.188
30	.5	.75	13	11	4.375	3	5.25	28	1.875	8	3	13	27.75
36	.625	.875	15.75	13.25	5.25	3.625	6.313	33.625	2.25	9.625	4	15.625	33.313
48	.75	1.25	20.5	17.5	7	4.75	8.375	45	3	12.813	5.25	20.75	44.375

C

WARNING SIGN COLORS:
 SYMBOL — BLACK
 BACKGROUND— YELLOW (RETROREFLECTIVE)

TTC SIGN COLORS:
 SYMBOL — BLACK
 BACKGROUND— ORANGE (RETROREFLECTIVE)

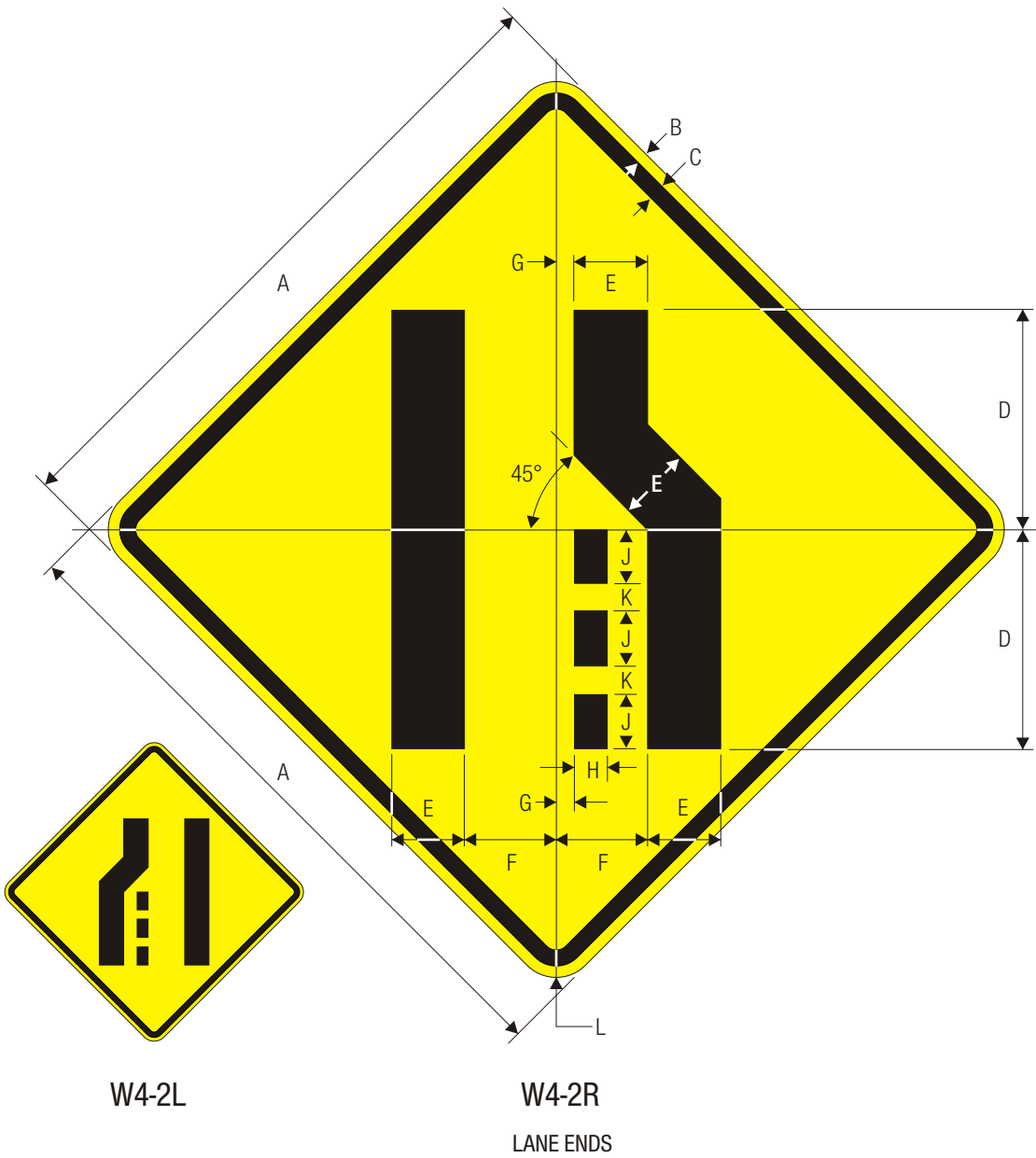

C	A	B	C	D	E	F	G	H	J	K	L
30	.5	.75	10	3.375	4.188	.875	1.5	2.5	1.25	1.875	
36	.625	.875	12	4	5	1	1.75	3	1.5	2.25	
48	.75	1.25	16	5.375	6.688	1.25	2.375	4	2	3	

WARNING SIGN COLORS:

SYMBOL — BLACK
BACKGROUND — YELLOW (RETROREFLECTIVE)

CONSTRUCTION SIGN COLORS:

SYMBOL — BLACK
BACKGROUND — ORANGE (RETROREFLECTIVE)

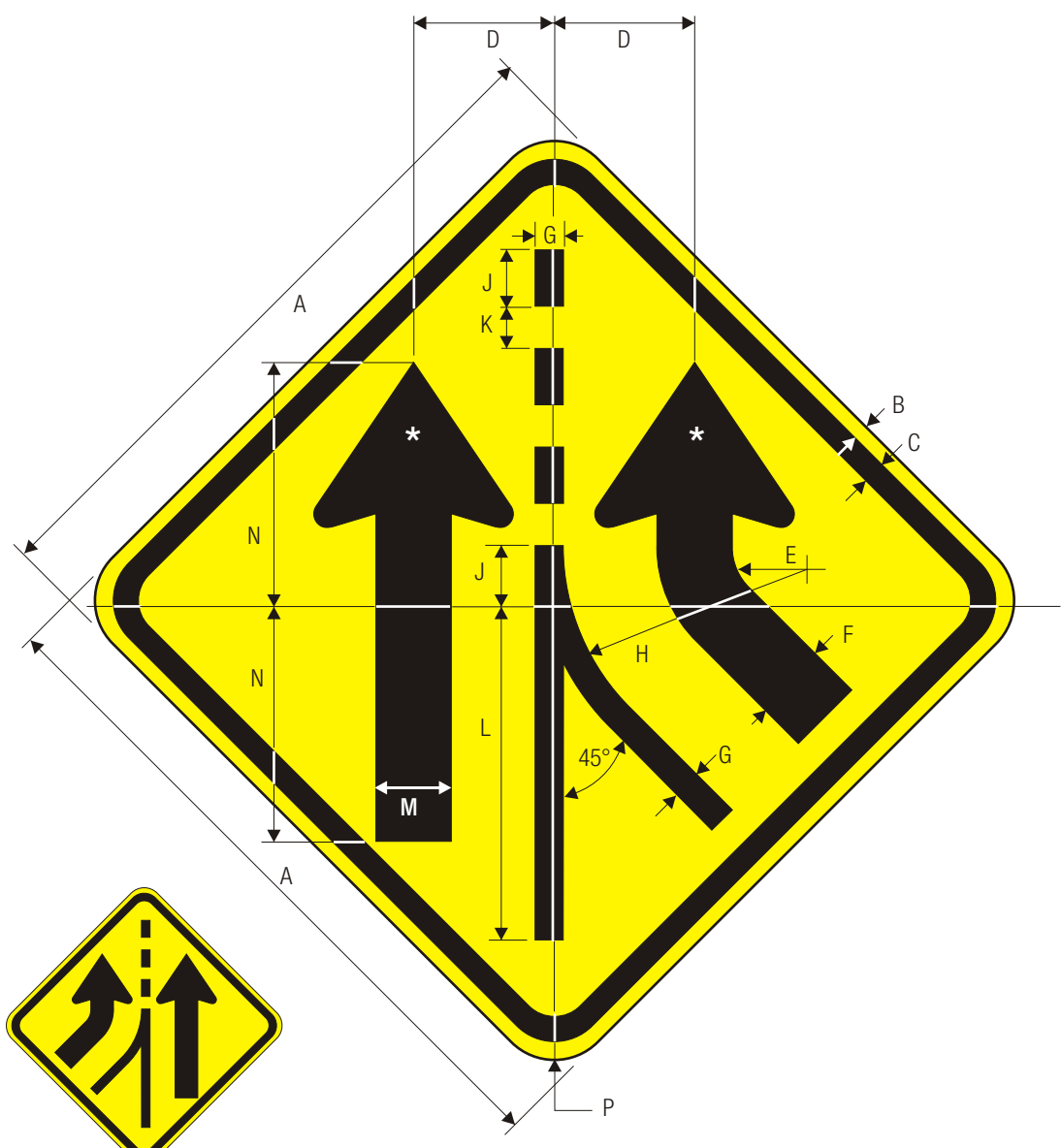

W4-3L

W4-3R

ADDED LANE

*See page 6-2 for symbol design.

A	B	C	D	E	F	G	H	J	K	L	M
36	.625	.825	7.5	3	4.125	1.5	11.813	3	2.25	18	4.125
48	.75	1.25	10	4	5.5	2	15.75	4	3	24	5.5

N	P
12.75	2.25
17	3

WARNING SIGN COLORS:
 SYMBOL — BLACK
 BACKGROUND— YELLOW (RETROREFLECTIVE)

TTC SIGN COLORS:
 SYMBOL — BLACK
 BACKGROUND— ORANGE (RETROREFLECTIVE)



W4-4p

TRAFFIC DOES NOT STOP



W4-4a



W4-4b

FOR USE WITH R1-1 STOP SIGN

*Series 2000 Standard Alphabets.

C

A	B	C	D	E	F	G	H	J	K	L	M	N
24	12	.375	.625	3	2.25 C	1.5	9.314	9.63	1.5	10.106	9.779	2.25 B
30	15	.5	.75	3.5	3 C	2	12.423	12.423	1.875	12.902	13.039	3 B
36	18	.625	.875	4	3.5 C	3	14.487	14.978	2.25	15.721	15.212	3.5 B
48	24	.75	1.25	5.5	4.5 C	4	18.628	19.259	3	20.214	19.56	4.5 B

COLORS: LEGEND — BLACK
BACKGROUND — YELLOW (RETROREFLECTIVE)

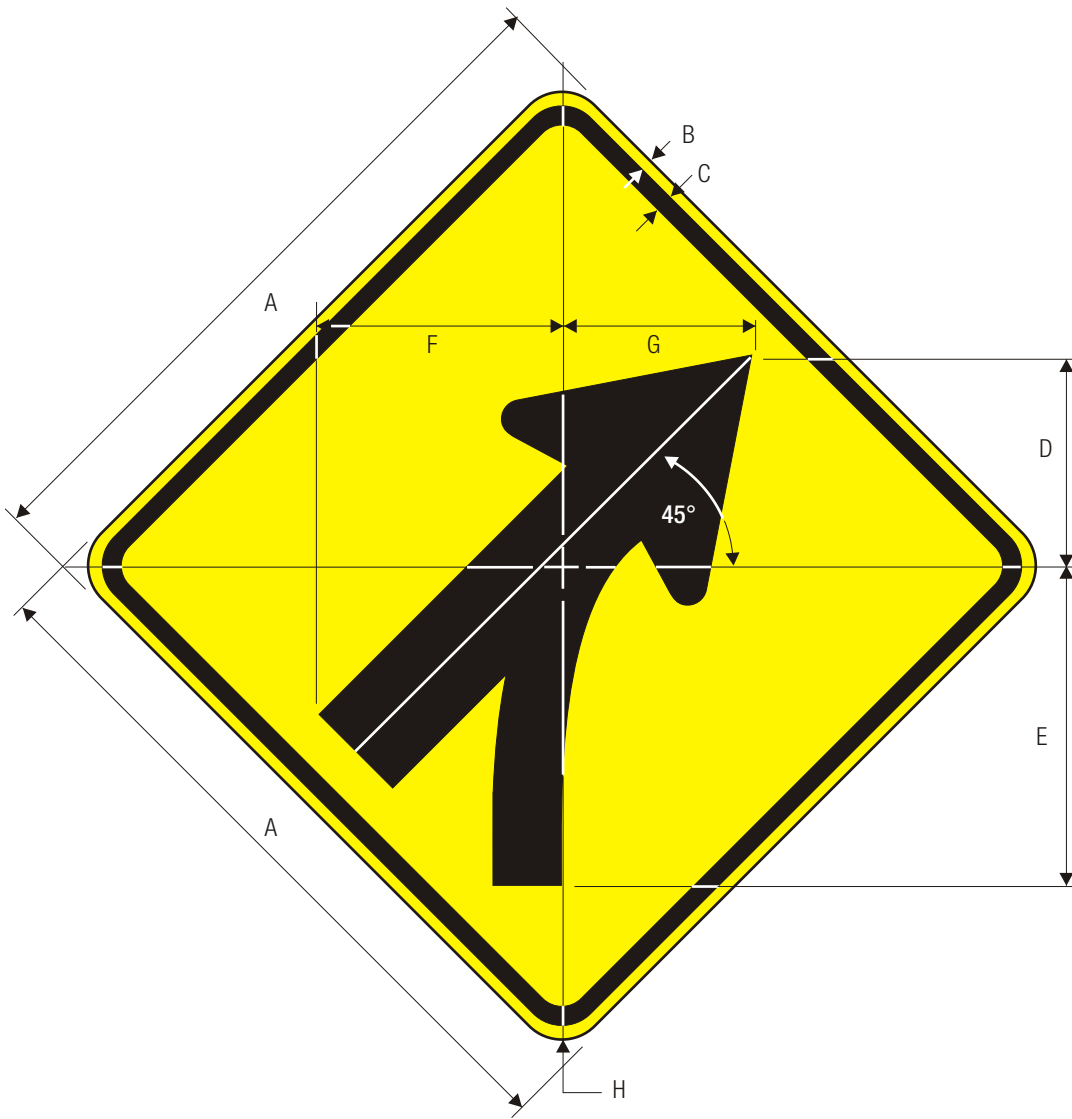

W4-5

ENTERING ROADWAY MERGE

*Scale and rotate W4-1 to fit dimensions.

	A	B	C	D	E	F	G	H
	24	.375	.625	7.285	11	8.366	6.524	1.5
	30	.5	.75	9.126	13.770	10.447	8.166	1.875
C	36	.625	.875	10.928	16.532	12.569	9.807	2.25
	48	.75	1.25	14.571	22	16.732	13.049	3

WARNING SIGN COLORS:

SYMBOL — BLACK
 BACKGROUND — YELLOW (RETROREFLECTIVE)

TTC SIGN COLORS:

SYMBOL — BLACK
 BACKGROUND — ORANGE (RETROREFLECTIVE)

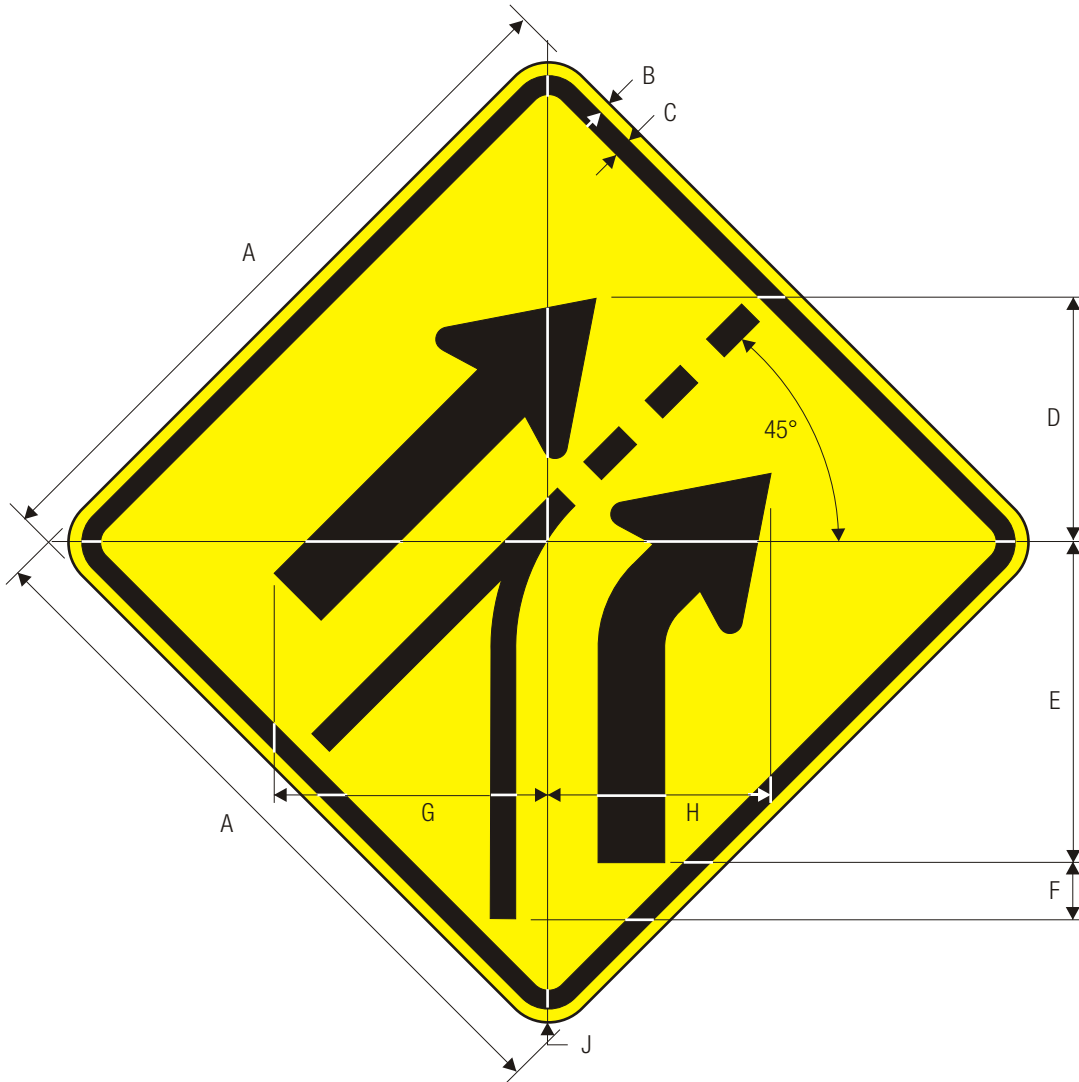

W4-6

ENTERING ROADWAY ADDED LANE

*Scale and rotate W4-3 to fit dimensions.

A	B	C	D	E	F	G	H	J
24	.375	.625	10.367	10.728	12.569	11.648	8.966	1.5
30	.5	.75	12.969	13.410	15.691	14.571	11.208	1.875
36	.625	.875	15.571	16.092	18.814	17.493	13.450	2.25
48	.75	1.25	20.735	21.456	25.139	23.297	17.933	3

C

WARNING SIGN COLORS:

LEGEND — BLACK
BACKGROUND — YELLOW (RETROREFLECTIVE)

TTC SIGN COLORS:

LEGEND — BLACK
BACKGROUND — ORANGE (RETROREFLECTIVE)



W5-1
ROAD NARROWS

C

A	B	C	D	E	F	G	H	J	K	L
30	.5	.75	5 D	3	1.75	7.875	8.625	14.75	15.125	1.875
36	.625	.875	6 D	3.5	2	9.5	10.313	17.625	18.25	2.25
48	.75	1.25	8 D	4	3	12.688	13.75	23.5	24.375	3

WARNING SIGN COLORS:
LEGEND — BLACK
BACKGROUND— YELLOW (RETROREFLECTIVE)

TTC SIGN COLORS:
LEGEND — BLACK
BACKGROUND— ORANGE (RETROREFLECTIVE)



W5-2
NARROW BRIDGE

*Reduce spacing 20%.

	A	B	C	D	E	F	G	H	J
	24	.375	.625	4 D	.25	2	10.438	8.75	1.5
	30	.5	.75	5 D	.5	2.5	13.063	10.875	1.875
C	36	.625	.875	6 D	.75	3	15.688	13.063	2.25
	48	.75	1.25	8 D	.5	4	20.875	17.375	3

WARNING SIGN COLORS:
LEGEND — BLACK
BACKGROUND— YELLOW (RETROREFLECTIVE)

TTC SIGN COLORS:
LEGEND — BLACK
BACKGROUND— ORANGE (RETROREFLECTIVE)

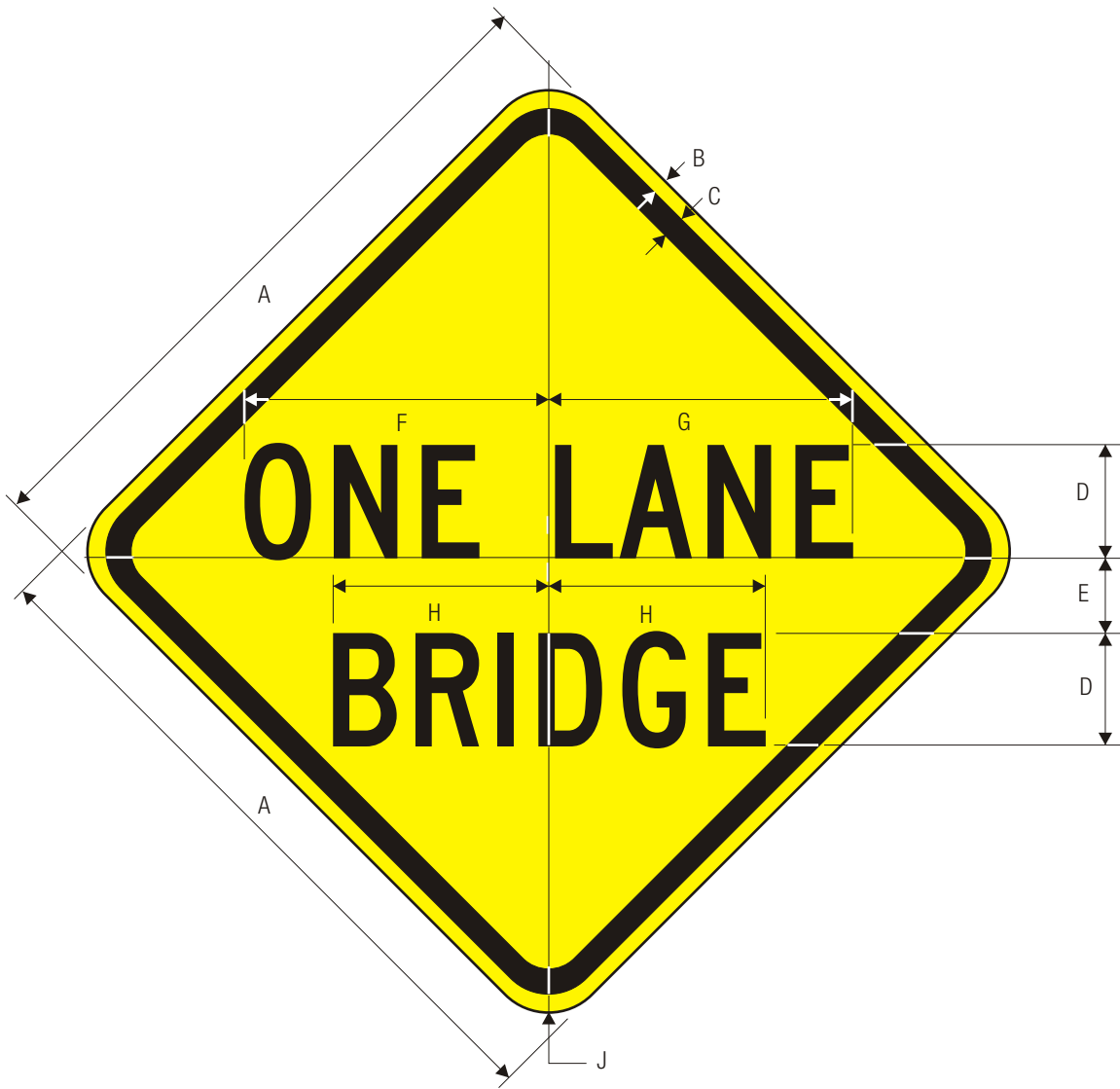

W5-3

ONE LANE BRIDGE

A	B	C	D	E	F	G	H	J
24	.375	.625	4 C	2.5	10.625	10.625	7.688	1.5
30	.5	.75	5 C	3.25	13.313	12.688	9.125	1.875
C 36	.625	.875	6 C	4	16	15.25	11.5	2.25
48	.75	1.25	8 C	5	21.25	20.25	15.375	3

WARNING SIGN COLORS:
 LEGEND — BLACK
 BACKGROUND— YELLOW (RETROREFLECTIVE)

TTC SIGN COLORS:
 LEGEND — BLACK
 BACKGROUND— ORANGE (RETROREFLECTIVE)



W5-4

RAMP NARROWS

A	B	C	D	E	F	G	H	J
30	.5	.75	5 D	2.722	1.080	8.626	14.951	1.875
36	.625	.875	6 D	3.122	1.280	10.367	17.933	2.25
48	.75	1.25	8 D	5.884	1.681	13.890	24.058	3

C

WARNING SIGN COLORS:

LEGEND — BLACK
 BACKGROUND — YELLOW (RETROREFLECTIVE)

TTC SIGN COLORS:

LEGEND — BLACK
 BACKGROUND — ORANGE (RETROREFLECTIVE)



W5-4a

BIKEWAY NARROWS

*Series 2000 Standard Alphabets.

A	B	C	D	E	F	G	H	J
18	.375	.625	.625	3 C	1	6.845	7.529	1.5
30	.5	.75	1	5 C	1.813	11.406	12.545	1.875

COLORS: LEGEND — BLACK
 BACKGROUND — YELLOW (RETROREFLECTIVE)

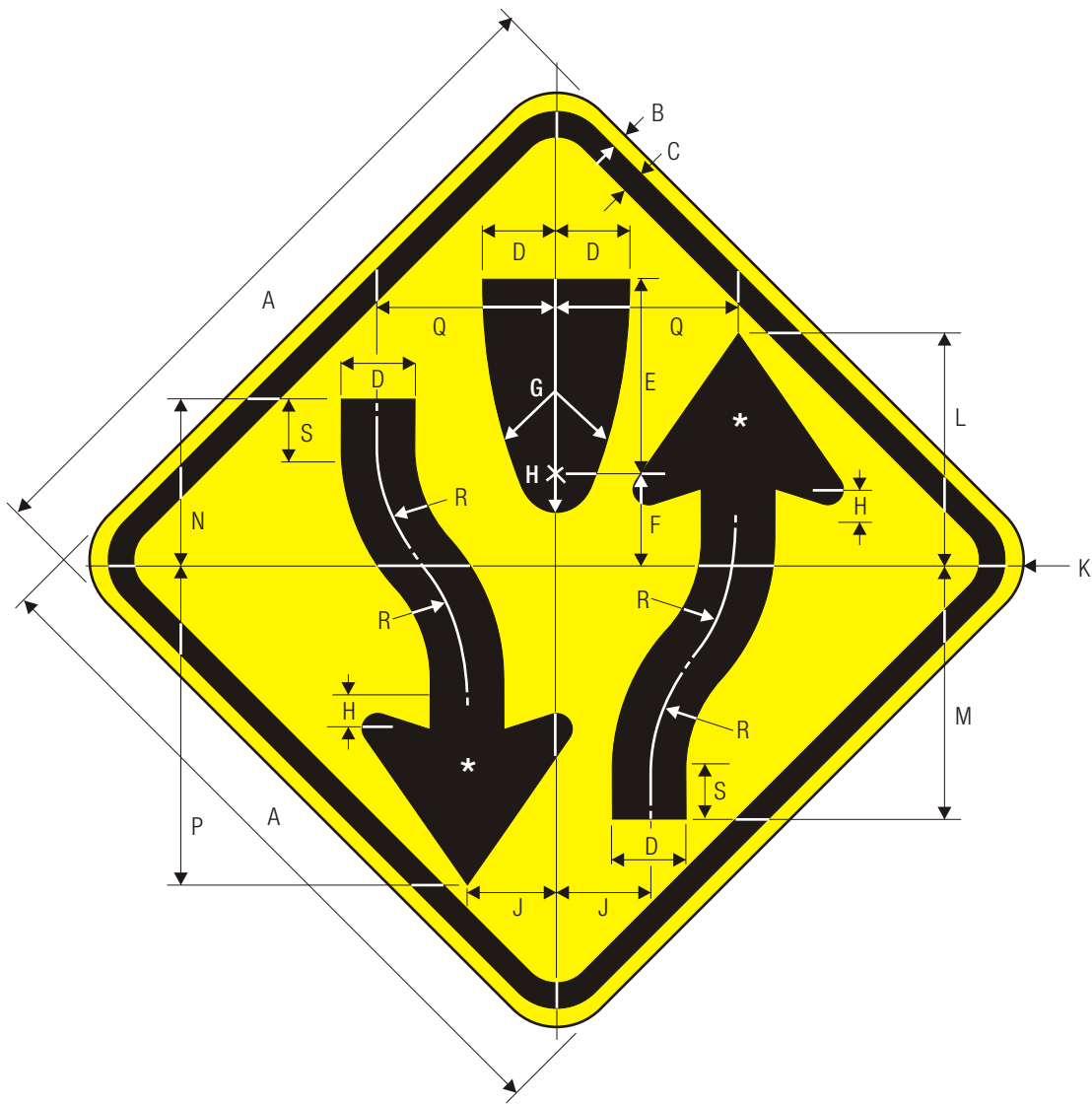

W6-1

DIVIDED HIGHWAY

*See page 6-2 for arrow design.

A	B	C	D	E	F	G	H	J	K	L	M
30	.5	.75	3.313	8.313	4.125	25	1.688	4.125	1.875	10	11.625
36	.625	.875	4	10	5	30	2	5	2.25	12	14
48	.75	1.25	5.25	13.125	6.563	39.313	2.625	6.563	3	16	18.688

C

N	P	Q	R	S
7.938	13.688	7.875	8.313	2.063
9.5	16.5	9.5	10	2.5
12.688	22	12.438	13.125	3.313

WARNING SIGN COLORS:
 SYMBOL — BLACK
 BACKGROUND— YELLOW (RETROREFLECTIVE)

TTC SIGN COLORS:
 SYMBOL — BLACK
 BACKGROUND— ORANGE (RETROREFLECTIVE)



W6-1a

DIVIDED HIGHWAY

*Series 2000 Standard Alphabets.

A	B	C	D	E	F	G	H	J
24	.375	.625	4 C	2	1.361	8.286	9.447	1.5
30	.5	.75	5 C	2.481	1.721	10.367	11.808	1.875
C 36	.625	.875	6 C	3	2.081	12.449	14.170	2.25
48	.75	1.25	8 C	4	2.802	16.592	18.894	3

COLORS: LEGEND — BLACK
 BACKGROUND — YELLOW (RETROREFLECTIVE)



W6-1b

DIVIDED ROAD

*Series 2000 Standard Alphabets.

A	B	C	D	E	F	G	H	J
24	.375	.625	4 C	2	1.361	8.286	5.504	1.5
30	.5	.75	5 C	2.481	1.721	10.367	6.885	1.875
C 36	.625	.875	6 C	3	2.081	12.449	8.266	2.25
48	.75	1.25	8 C	4	2.802	16.592	11.028	3

COLORS: LEGEND — BLACK
 BACKGROUND — YELLOW (RETROREFLECTIVE)

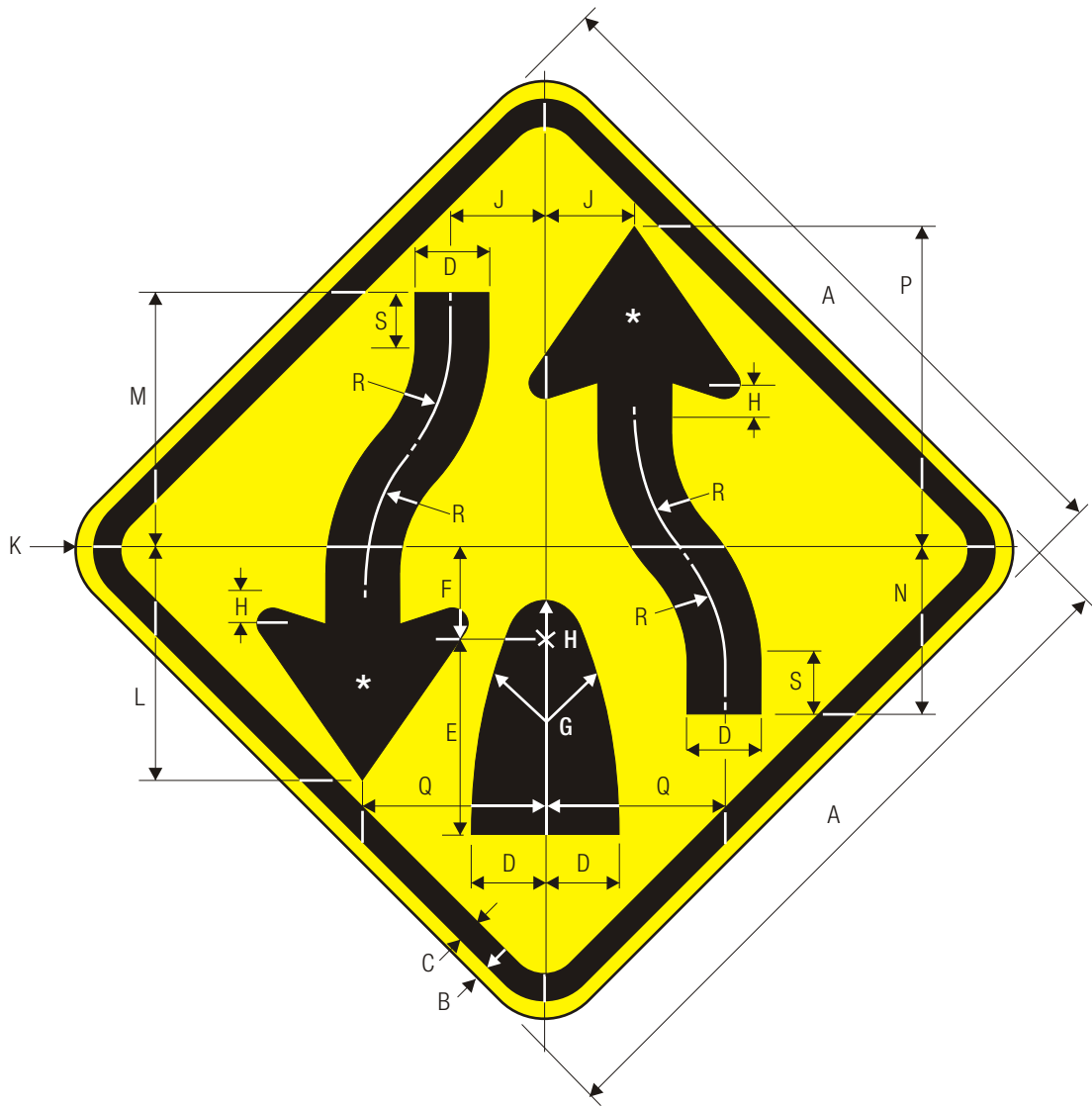

W6-2
DIVIDED HIGHWAY ENDS

*See page 6-2 for arrow design.

A	B	C	D	E	F	G	H	J	K	L	M
30	.5	.75	3.313	8.313	4.125	25	1.688	4.125	1.875	10	11.875
36	.625	.875	4	10	5	30	2	5	2.25	12	14
48	.75	1.25	5.25	13.125	6.563	39.313	2.625	6.563	3	16	18.688

C

N	P	Q	R	S
7.938	13.703	7.875	8.313	2.063
9.5	16.5	9.5	10	2.5
12.688	22	12.438	13.125	3.313

WARNING SIGN COLORS:

SYMBOL — BLACK
BACKGROUND — YELLOW (RETROREFLECTIVE)

TTC SIGN COLORS:

SYMBOL — BLACK
BACKGROUND — ORANGE (RETROREFLECTIVE)



W6-2a

DIVIDED HIGHWAY ENDS

*Series 2000 Standard Alphabets.

	A	B	C	D	E	F	G	H	J	K
	30	.5	.75	5 C	2.481	.760	10.367	11.808	6.805	1.875
C	36	.625	.875	6 C	3	.880	12.449	14.170	8.166	2.25
	48	.75	1.25	8 C	4	.960	16.592	18.894	10.888	3

WARNING SIGN COLORS:

LEGEND — BLACK
BACKGROUND — YELLOW (RETROREFLECTIVE)

TTC SIGN COLORS:

LEGEND — BLACK
BACKGROUND — ORANGE (RETROREFLECTIVE)



W6-2b

DIVIDED ROAD ENDS

*Series 2000 Standard Alphabets.

	A	B	C	D	E	F	G	H	J	K
	24	.375	.625	4 C	2	.400	8.286	5.505	5.444	1.5
	30	.5	.75	5 C	2.481	.760	10.367	6.885	6.805	1.875
C	36	.625	.875	6 C	3	.880	12.449	8.266	8.166	2.25
	48	.75	1.25	8 C	4	.960	16.592	11	10.888	3

WARNING SIGN COLORS:

LEGEND — BLACK
 BACKGROUND — YELLOW (RETROREFLECTIVE)

TTC SIGN COLORS:

LEGEND — BLACK
 BACKGROUND — ORANGE (RETROREFLECTIVE)

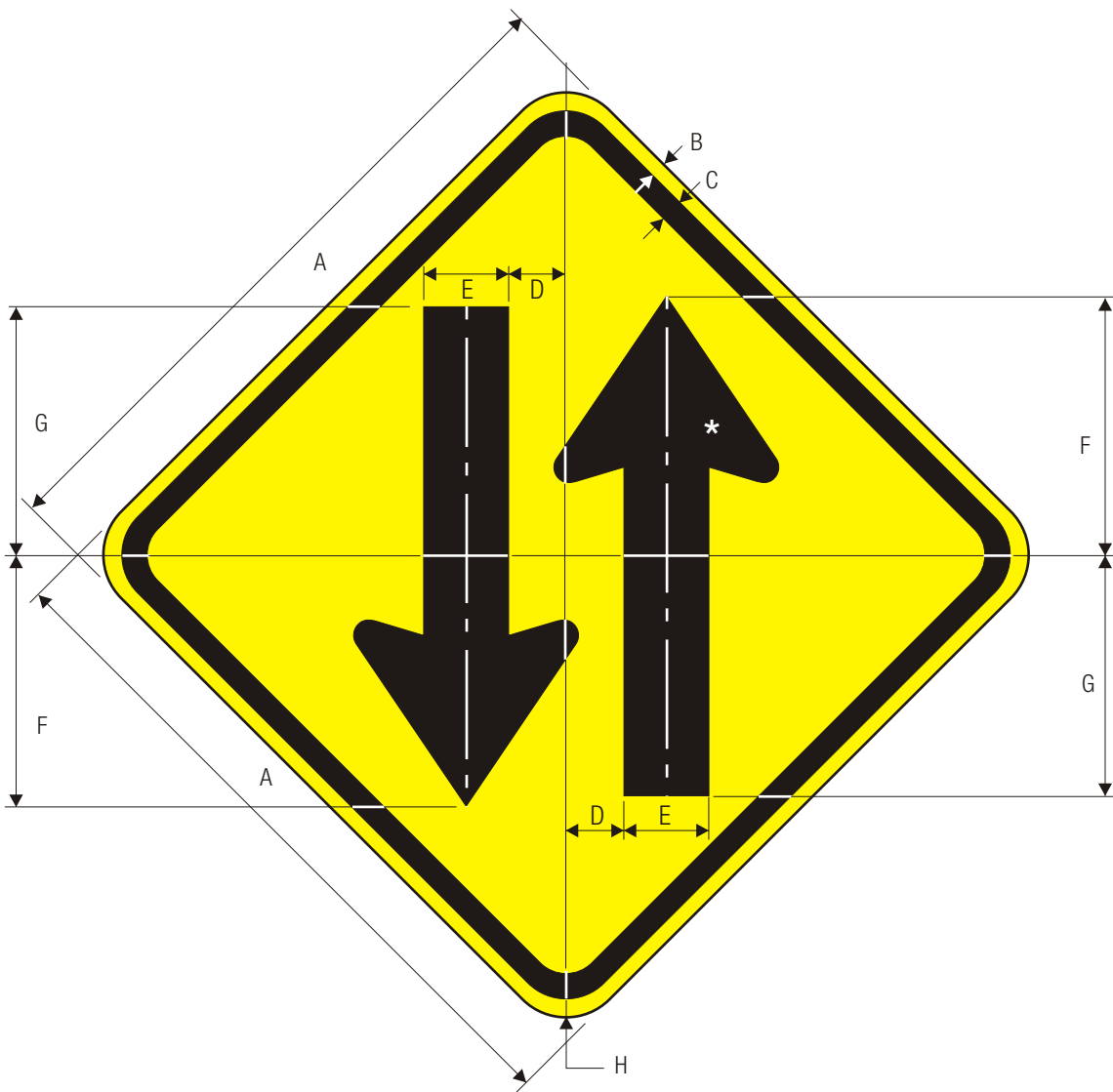

W6-3

TWO WAY TRAFFIC

*See page 6-2 for arrow design.

	A	B	C	D	E	F	G	H
	30	.5	.75	2.438	3.75	11.25	10.625	1.875
C	36	.625	.875	2.938	4.25	13.5	12.75	2.25
	48	.75	1.25	3.875	6	18	17	3

WARNING SIGN COLORS:

SYMBOL — BLACK
 BACKGROUND — YELLOW (RETROREFLECTIVE)

TTC SIGN COLORS:

SYMBOL — BLACK
 BACKGROUND — ORANGE (RETROREFLECTIVE)

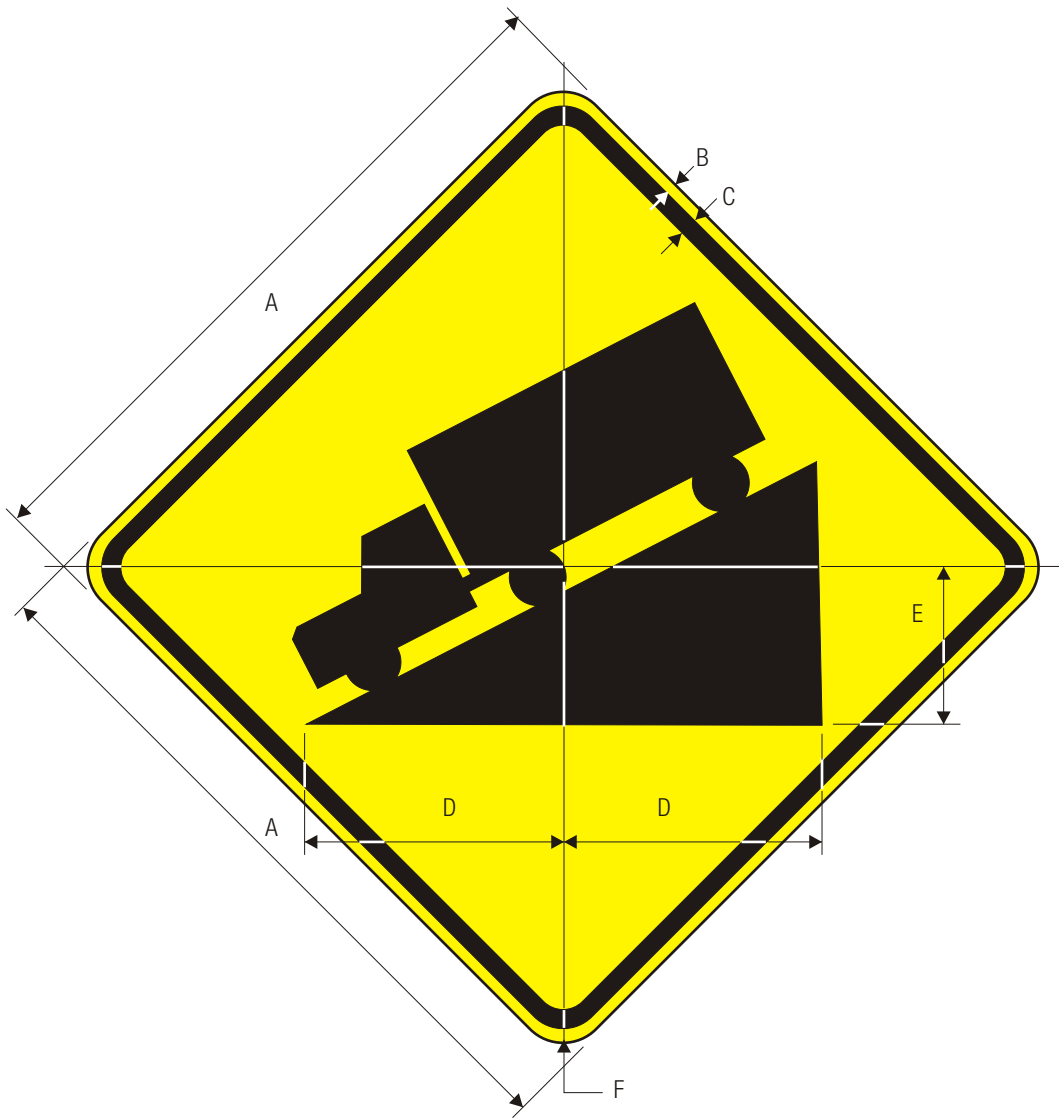

W7-1
HILL

*See page 6-22 for symbol design.

	A	B	C	D	E	F
	24	.375	.625	8.75	6	1.5
C	30	.5	.75	11	7.5	1.875
	36	.625	.875	13.25	9	2.25
	48	.75	1.25	17.5	12	3

WARNING SIGN COLORS:
SYMBOL — BLACK
BACKGROUND— YELLOW (RETROREFLECTIVE)

TTC SIGN COLORS:
SYMBOL — BLACK
BACKGROUND— ORANGE (RETROREFLECTIVE)

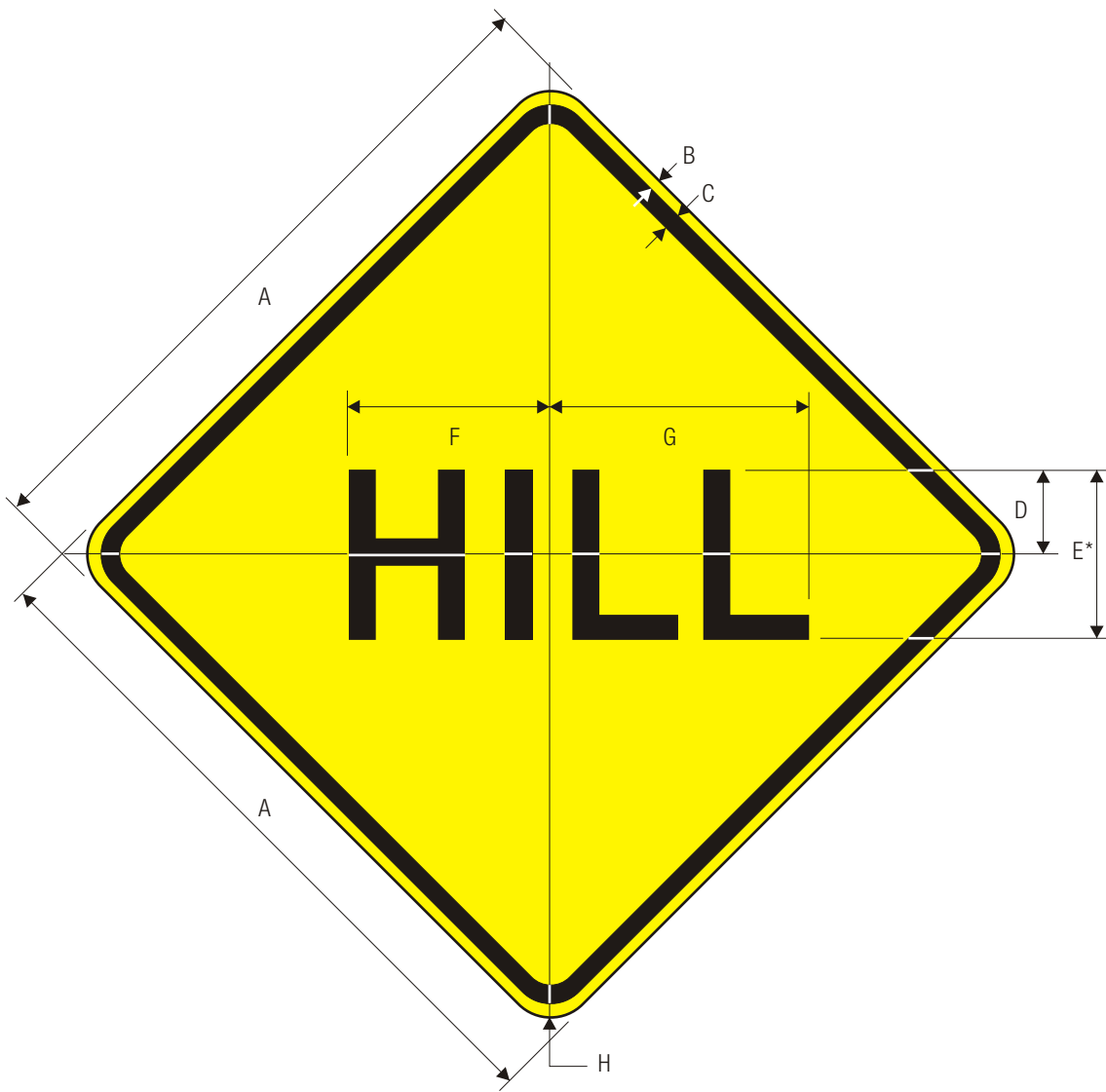

W7-1a
HILL

*Series 2000 Standard Alphabets.

	A	B	C	D	E	F	G	H
	24	.375	.625	3	6 D	7.085	9.126	1.5
C	30	.5	.75	4	8 D	9.647	11.969	1.875
	36	.625	.875	5	10 D	12.169	14.851	2.25
	48	.75	1.25	6	12 D	14.531	17.893	3

WARNING SIGN COLORS:
LEGEND — BLACK
BACKGROUND— YELLOW (RETROREFLECTIVE)

TTC SIGN COLORS:
LEGEND — BLACK
BACKGROUND— ORANGE (RETROREFLECTIVE)

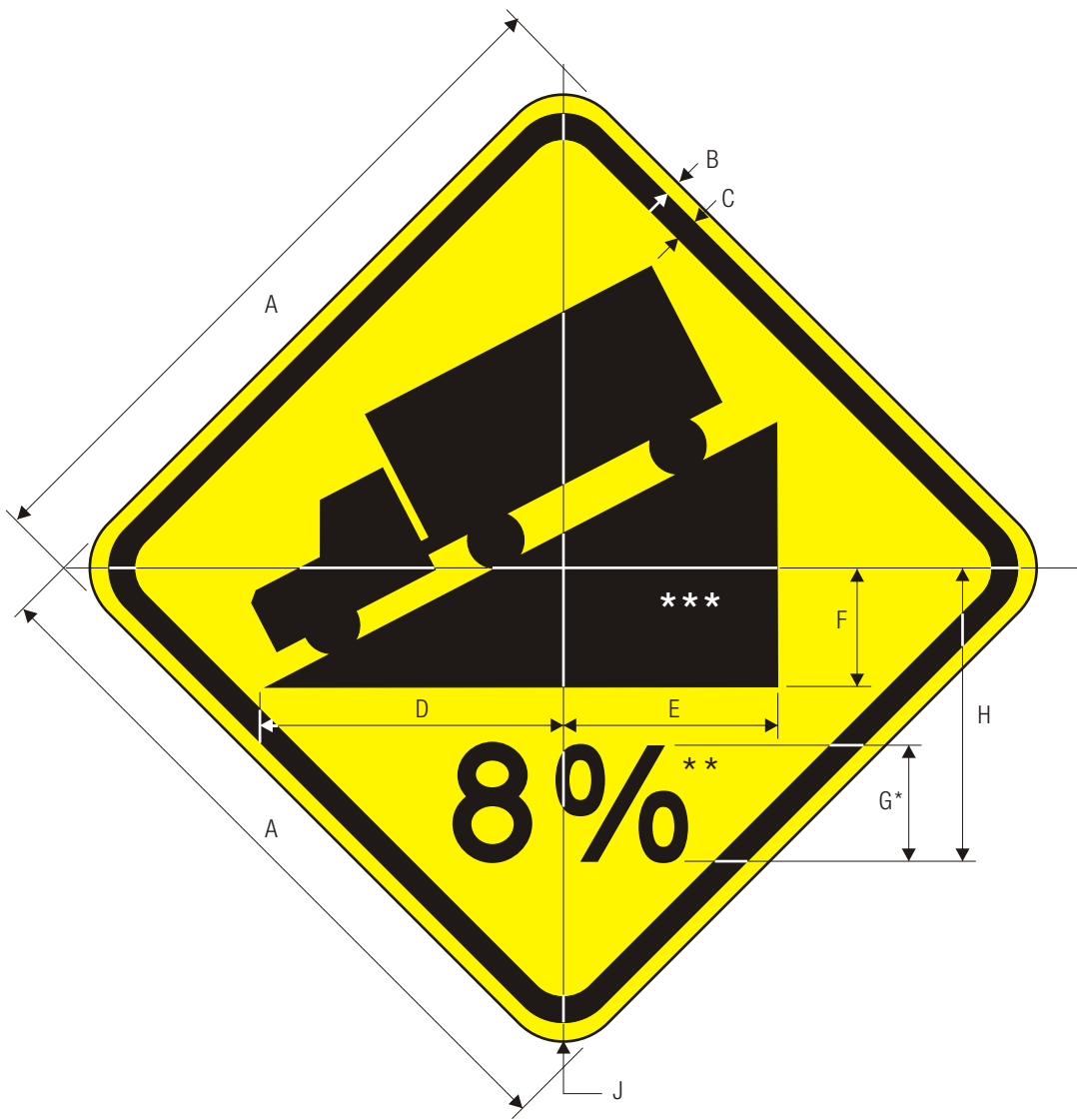

W7-1b
HILL

*Series 2000 Standard Alphabets.
 **Optically space numeral and % about centerline.
 ***See page 6-22 for symbol design.

	A	B	C	D	E	F	G	H	J
	24	.375	.625	10.25	7.25	4	4 D	10	1.5
C	30	.5	.75	12.75	9.25	5	5 D	12.5	1.875
	36	.625	.875	15.375	11.125	6	6 D	15	2.25
	48	.75	1.25	20.5	14.5	8	8 D	20	3

WARNING SIGN COLORS:
 SYMBOL & LEGEND—BLACK
 BACKGROUND—YELLOW (RETROREFLECTIVE)

TTC SIGN COLORS:
 SYMBOL & LEGEND—BLACK
 BACKGROUND—ORANGE (RETROREFLECTIVE)

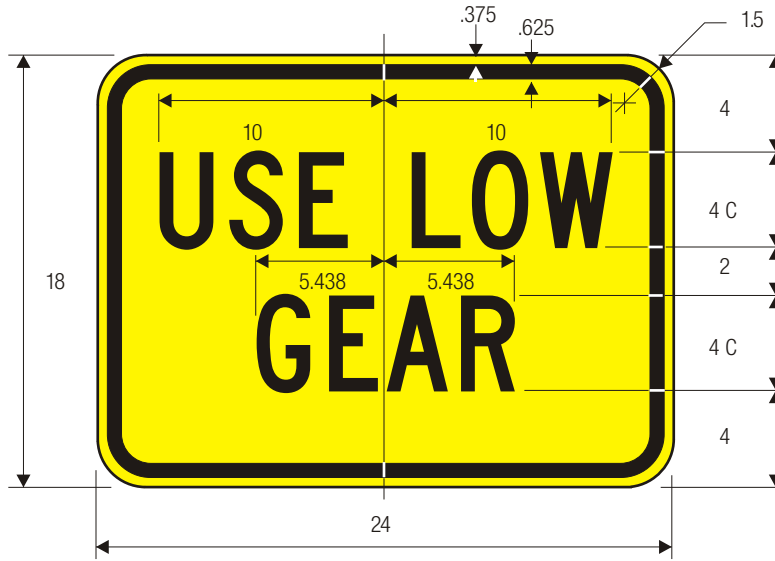

W7-2

HILL PLAQUE

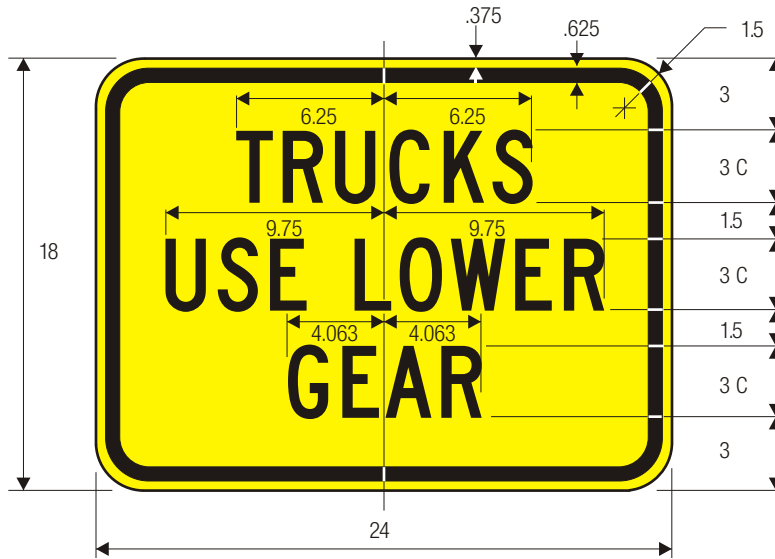

W7-2b

HILL PLAQUE

COLORS: LEGEND — BLACK
 BACKGROUND — YELLOW (RETROREFLECTIVE)

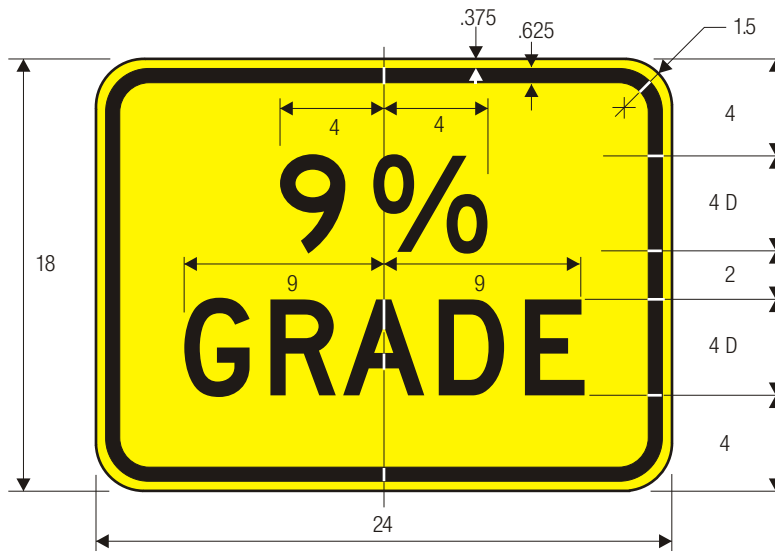

W7-3

HILL PLAQUE



W7-3a

HILL PLAQUE

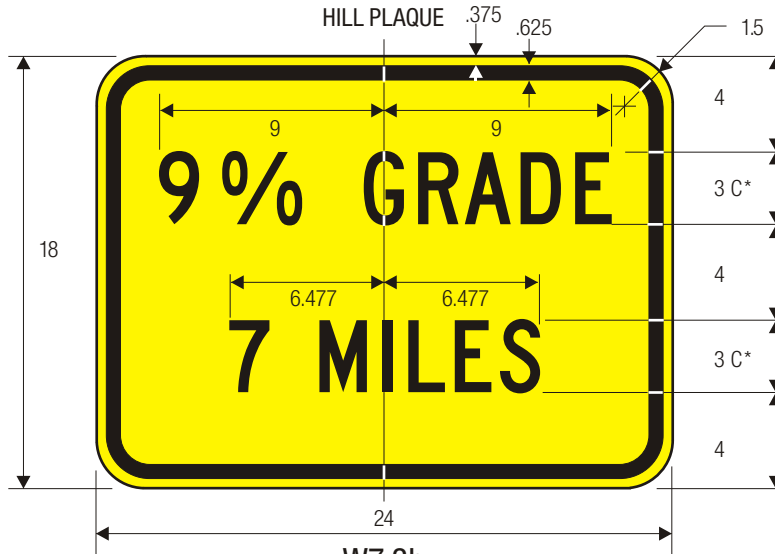

W7-3b

HILL PLAQUE

*Series 2000 Standard Alphabets.

COLORS: LEGEND — BLACK
 BACKGROUND — YELLOW (RETROREFLECTIVE)

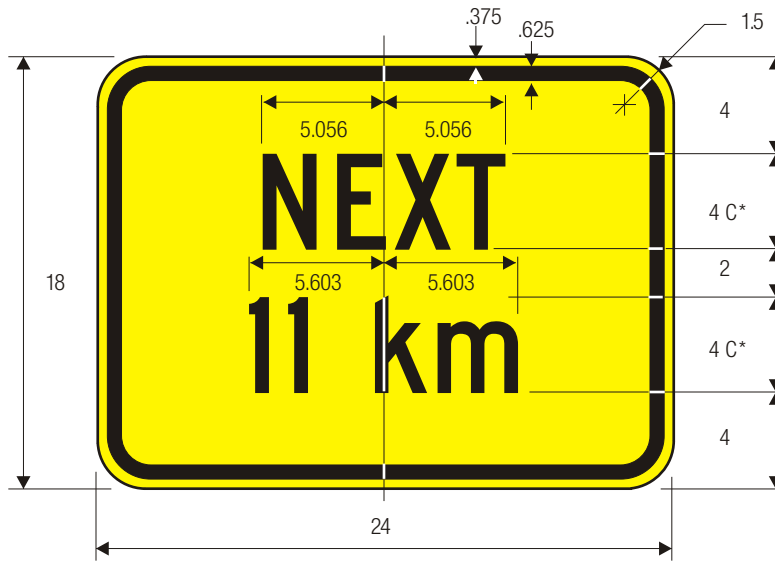

W7-3a Metric
HILL PLAQUE

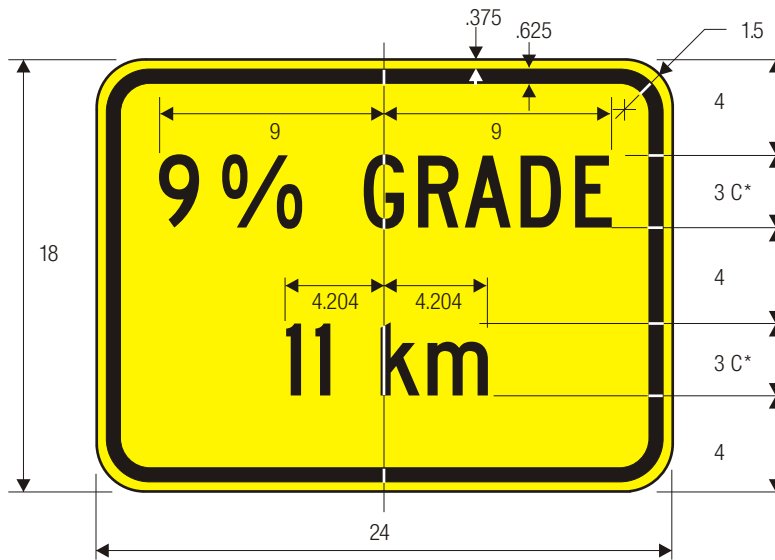

W7-3b Metric
HILL PLAQUE

*Series 2000 Standard Alphabets.

COLORS: LEGEND — BLACK
BACKGROUND — YELLOW (RETROREFLECTIVE)

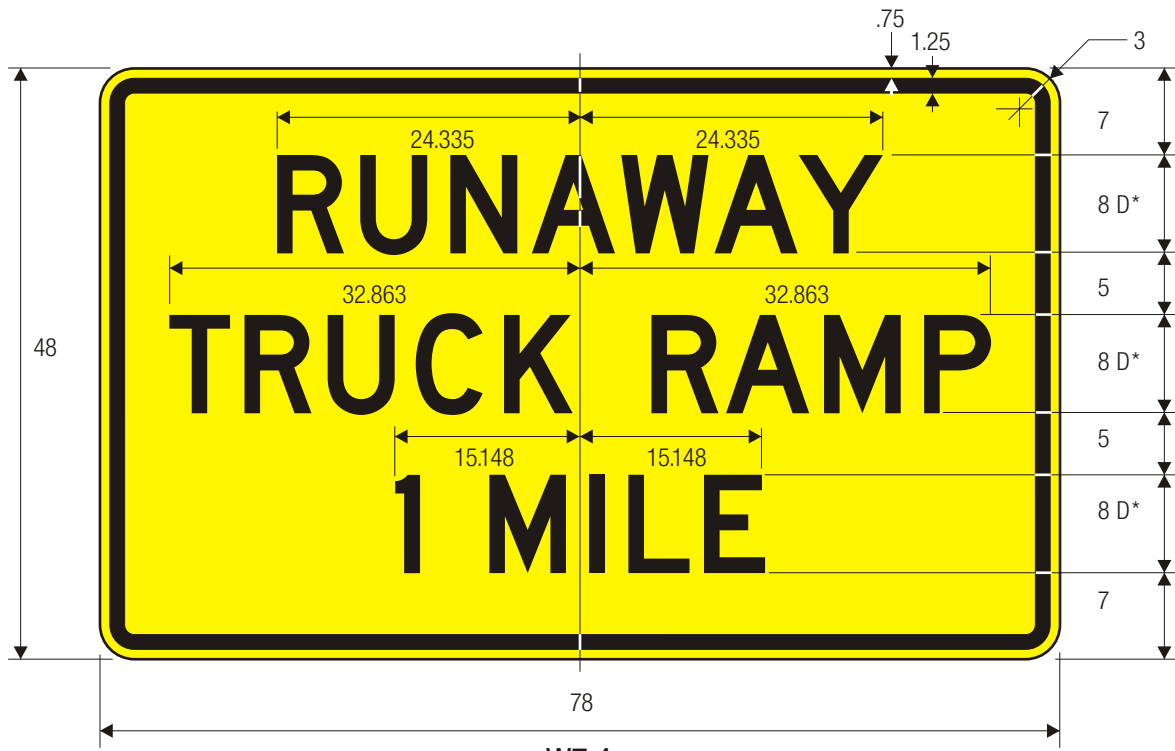

W7-4

TRUCK ESCAPE RAMP



W7-4b

TRUCK ESCAPE RAMP

*Series 2000 Standard Alphabets.
 **See page 6-3 for arrow design.

COLORS: LEGEND — BLACK
 BACKGROUND — YELLOW (RETROREFLECTIVE)

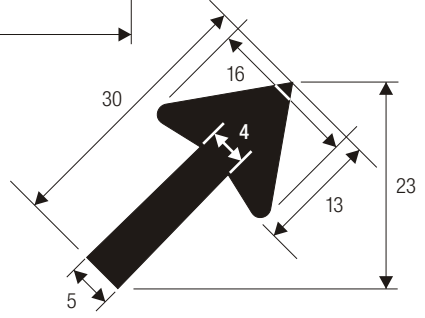



W7-4c

*Series 2000 Standard Alphabets.

TRUCK ESCAPE RAMP

COLORS: LEGEND — BLACK
 BACKGROUND — YELLOW (RETROREFLECTIVE)

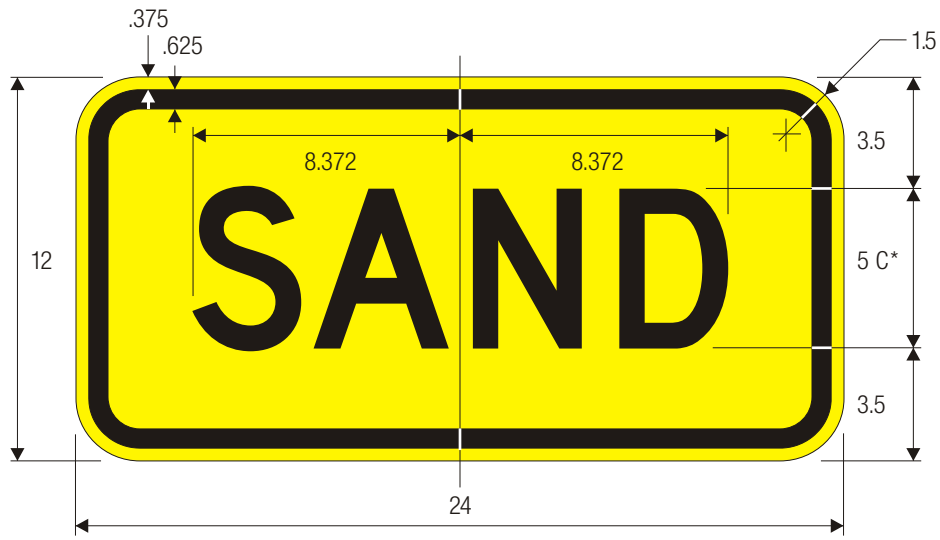

W7-4d

TRUCK ESCAPE RAMP PLAQUE

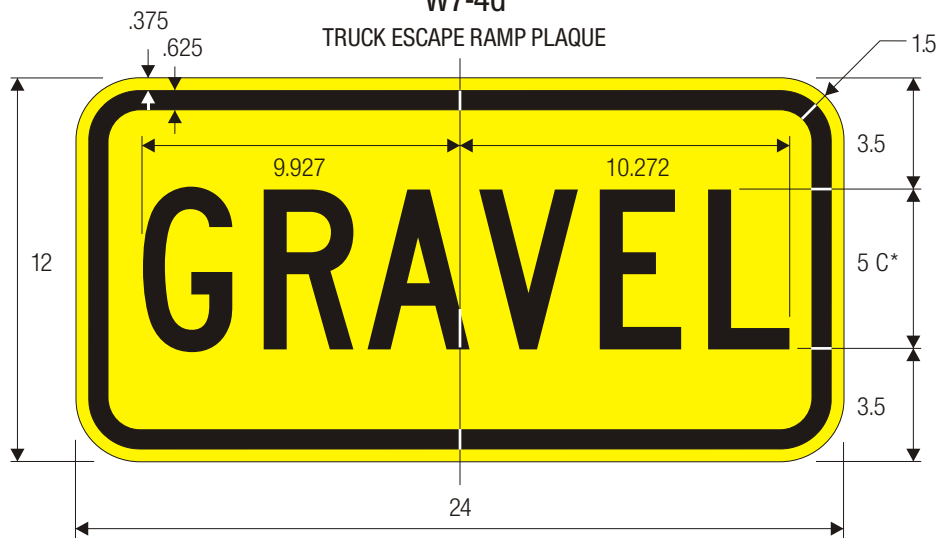

W7-4e

TRUCK ESCAPE RAMP PLAQUE

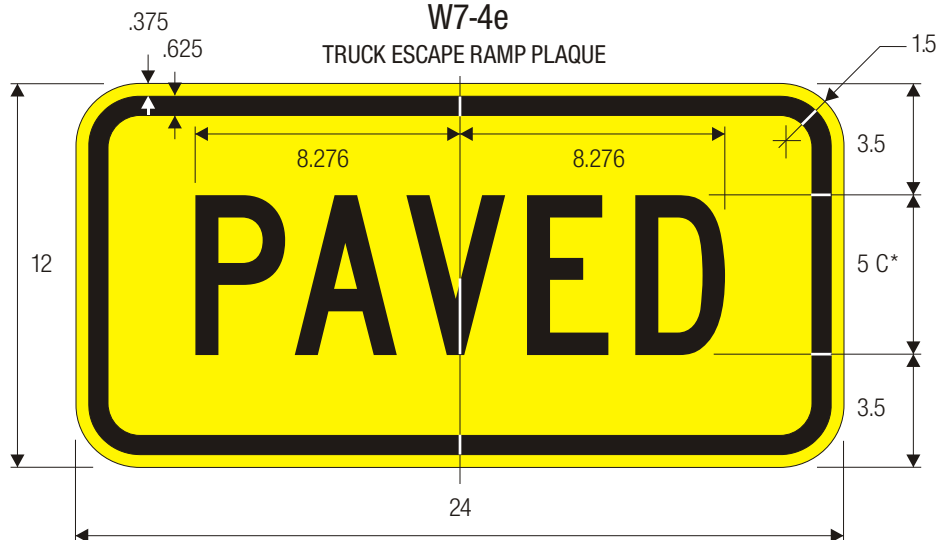

W7-4f

TRUCK ESCAPE RAMP PLAQUE

*Series 2000 Standard Alphabets.

COLORS: LEGEND — BLACK
 BACKGROUND — YELLOW (RETROREFLECTIVE)

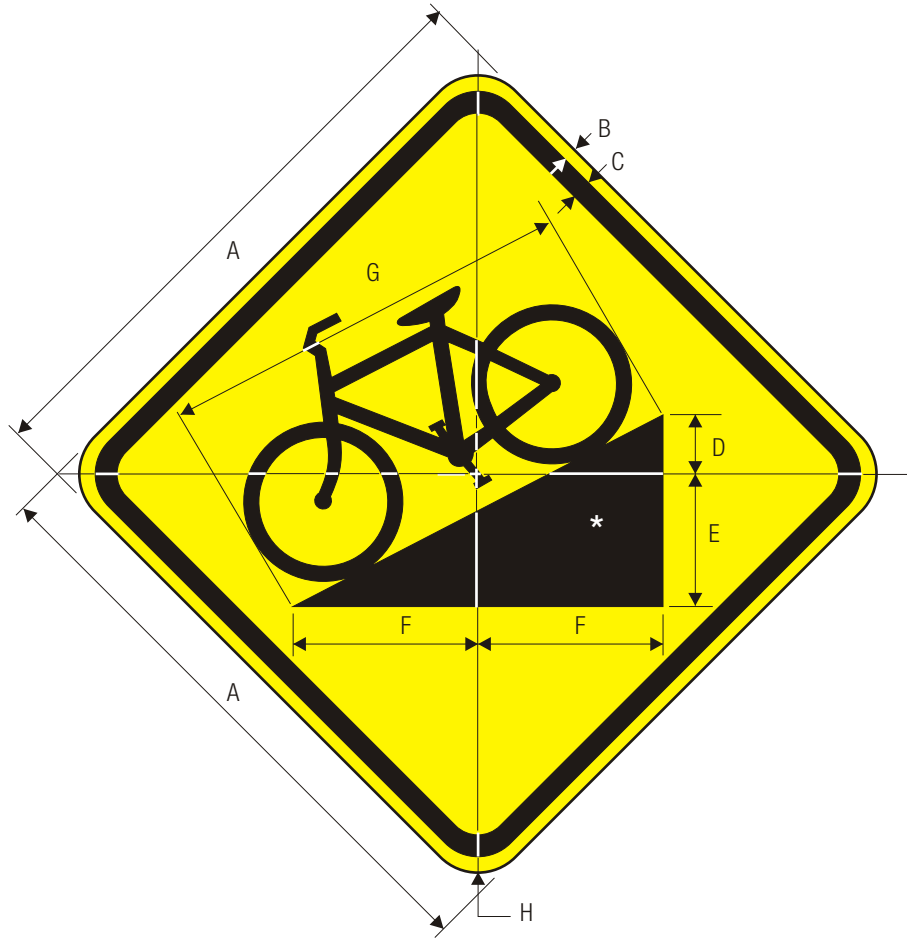

W7-5

*See page 6-7 for symbol design.

BICYCLE HILL PLAQUE

A	B	C	D	E	F	G	H
18	.375	.625	1.75	4	5.625	12.625	1.5
24	.375	.625	2.3	5.3	7.5	16.833	1.5

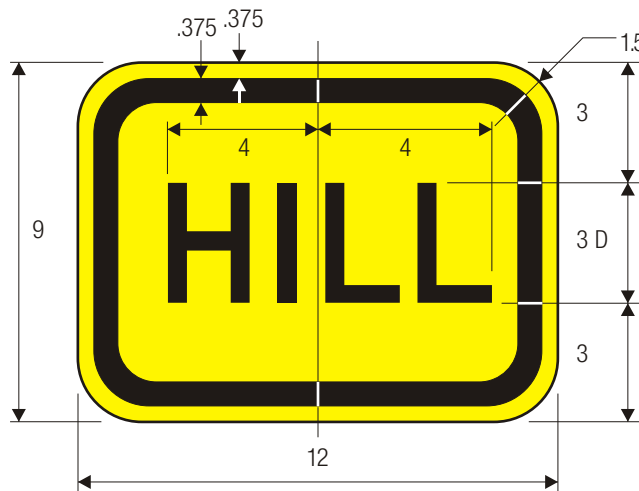

W7-5a

COLORS: LEGEND — BLACK
BACKGROUND — YELLOW (RETROREFLECTIVE)

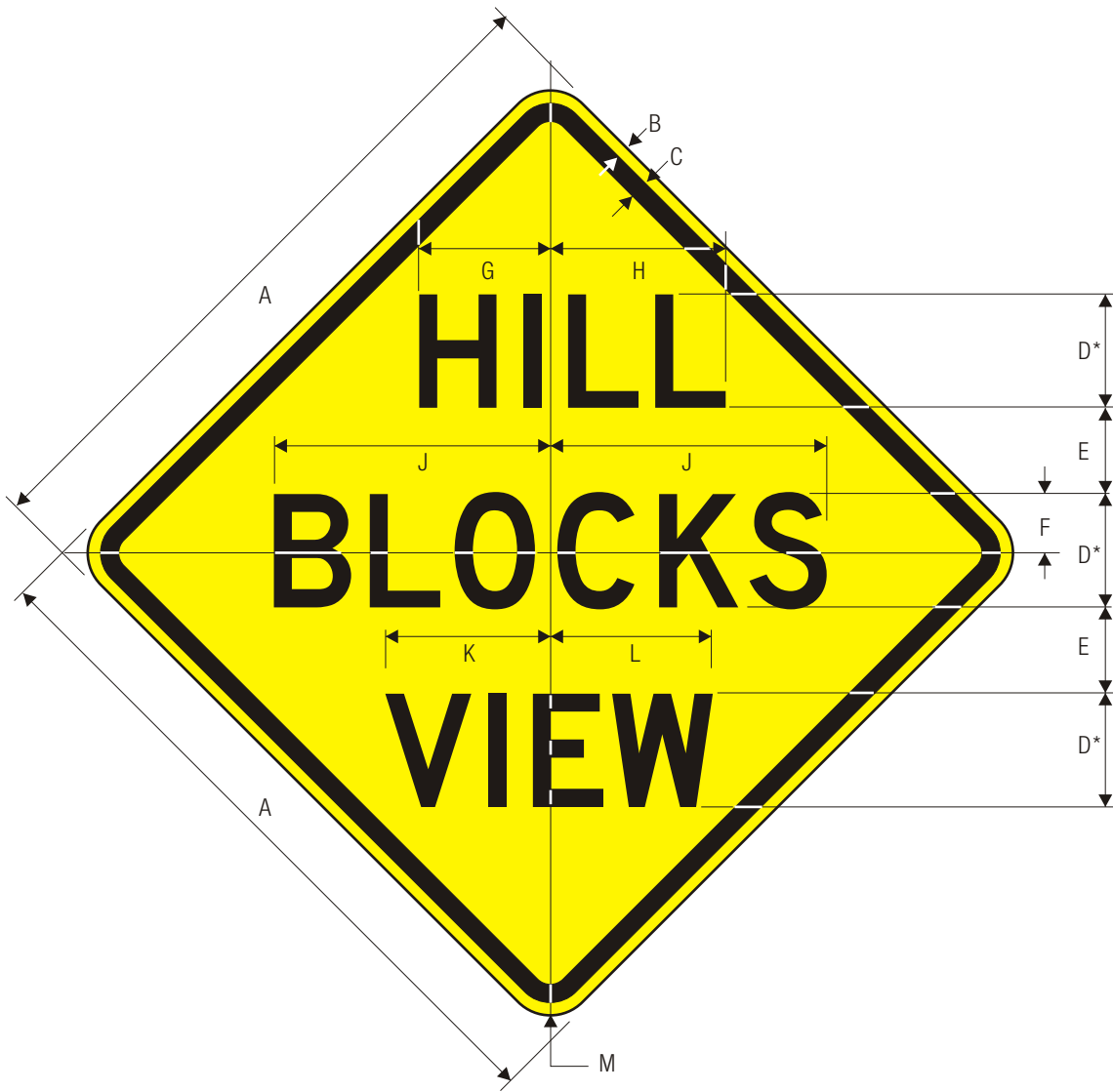

W7-6
HILL BLOCKS VIEW

*Series 2000 Standard Alphabets.

A	B	C	D	E	F	G	H	J	K	L	M
24	.375	.625	4 D	3	2	4.803	6	9.747	5.844	5.724	1.5
C 30	.5	.75	5 D	3.802	2.601	5.764	7.765	12.189	7.285	7.165	1.875
36	.625	.875	6 D	4.483	3	6.845	9.367	14.631	8.886	8.446	2.25
48	.75	1.25	7 D	5.243	3.522	8.326	10.608	17.052	10.167	10.047	3

COLORS: LEGEND — BLACK
BACKGROUND — YELLOW (RETROREFLECTIVE)

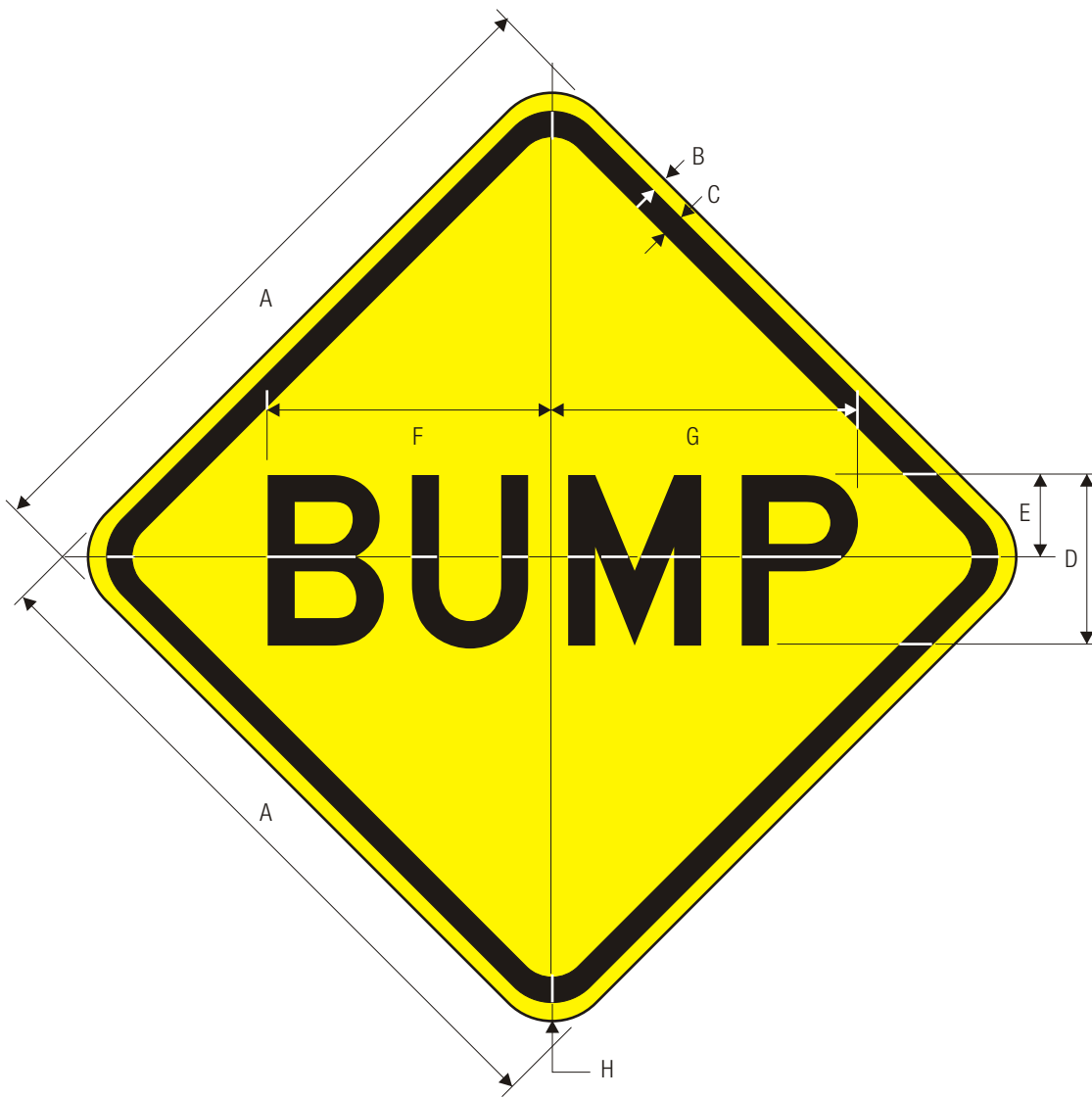

W8-1
BUMP

C

A	B	C	D	E	F	G	H
18	.375	.625	4 D	2	6.489	7.341	1.5
24	.375	.625	6 D	3	10.188	10.813	1.5
30	.5	.75	8 D	4	13.625	14.375	1.875
36	.625	.875	10 D	5	16.938	17.938	2.25
48	.75	1.25	12 D	6	20.375	21.625	3

WARNING SIGN COLORS:
LEGEND — BLACK
BACKGROUND— YELLOW (RETROREFLECTIVE)

TTC SIGN COLORS:
LEGEND — BLACK
BACKGROUND— ORANGE (RETROREFLECTIVE)

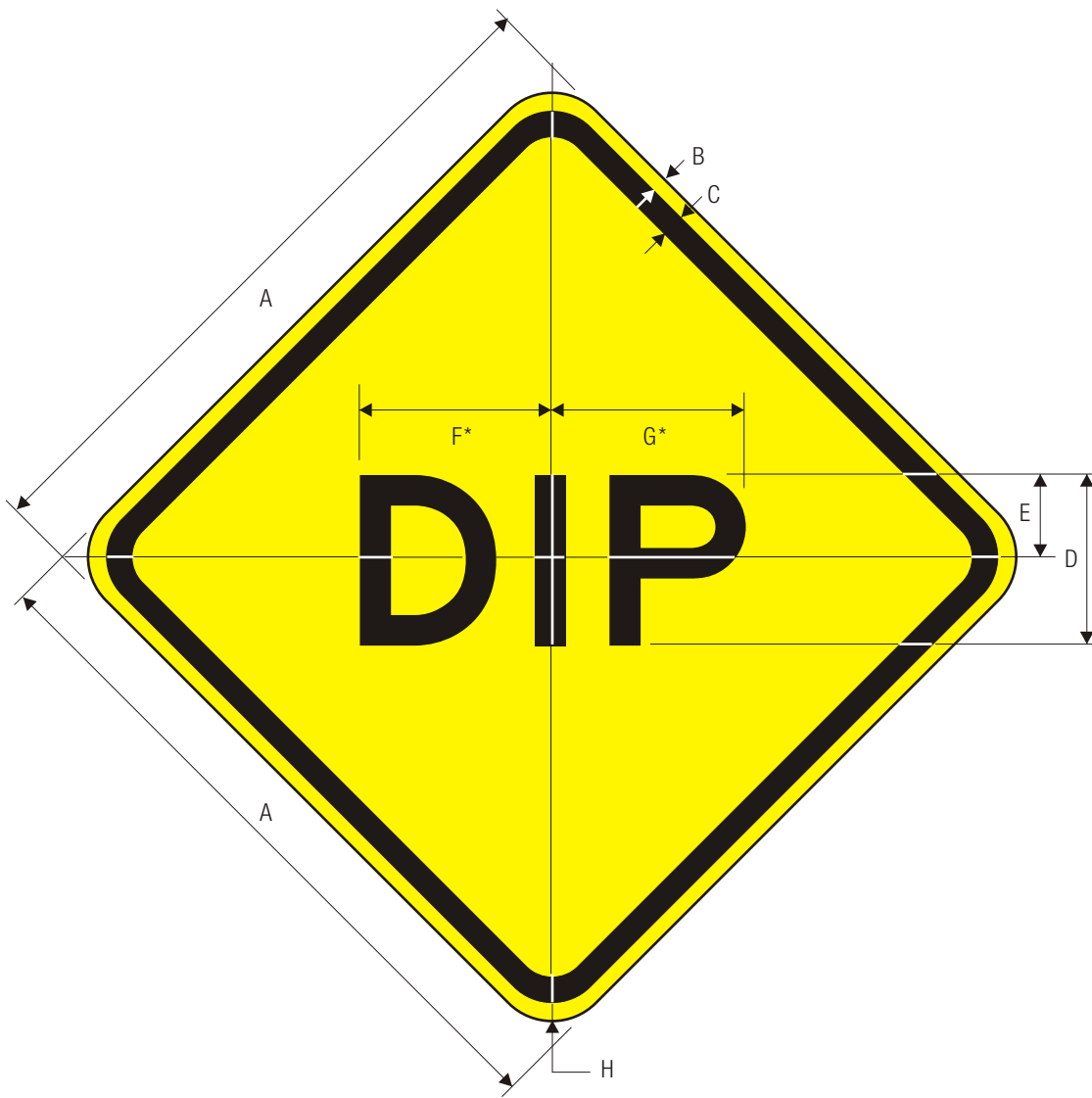

W8-2
DIP

*Increase spacing 50%

	A	B	C	D	E	F	G	H
	18	.375	.625	5 E	2.5	5.813	6.71	1.5
	24	.375	.625	6 E	3	7.125	8.125	1.5
C	30	.5	.75	8 E	4	9.5	10.875	1.875
	36	.625	.875	10 E	5	11.875	13.5	2.25
	48	.75	1.25	12 E	6	14.25	16.25	3

WARNING SIGN COLORS:

LEGEND — BLACK

BACKGROUND— YELLOW (RETROREFLECTIVE)

TTC SIGN COLORS:

LEGEND — BLACK

BACKGROUND— ORANGE (RETROREFLECTIVE)



W8-3
PAVEMENT ENDS

	A	B	C	D	E	F	G	H	J	K
	24	.375	.625	4 C	2.5	.5	11.188	5.313	5.438	1.5
C	30	.5	.75	5 C	3	.75	13.938	6.625	6.875	1.875
	36	.625	.875	6 C	3.5	1	16.75	7.875	8.25	2.25

WARNING SIGN COLORS:

LEGEND — BLACK

BACKGROUND— YELLOW (RETROREFLECTIVE)

TTC SIGN COLORS:

LEGEND — BLACK

BACKGROUND— ORANGE (RETROREFLECTIVE)

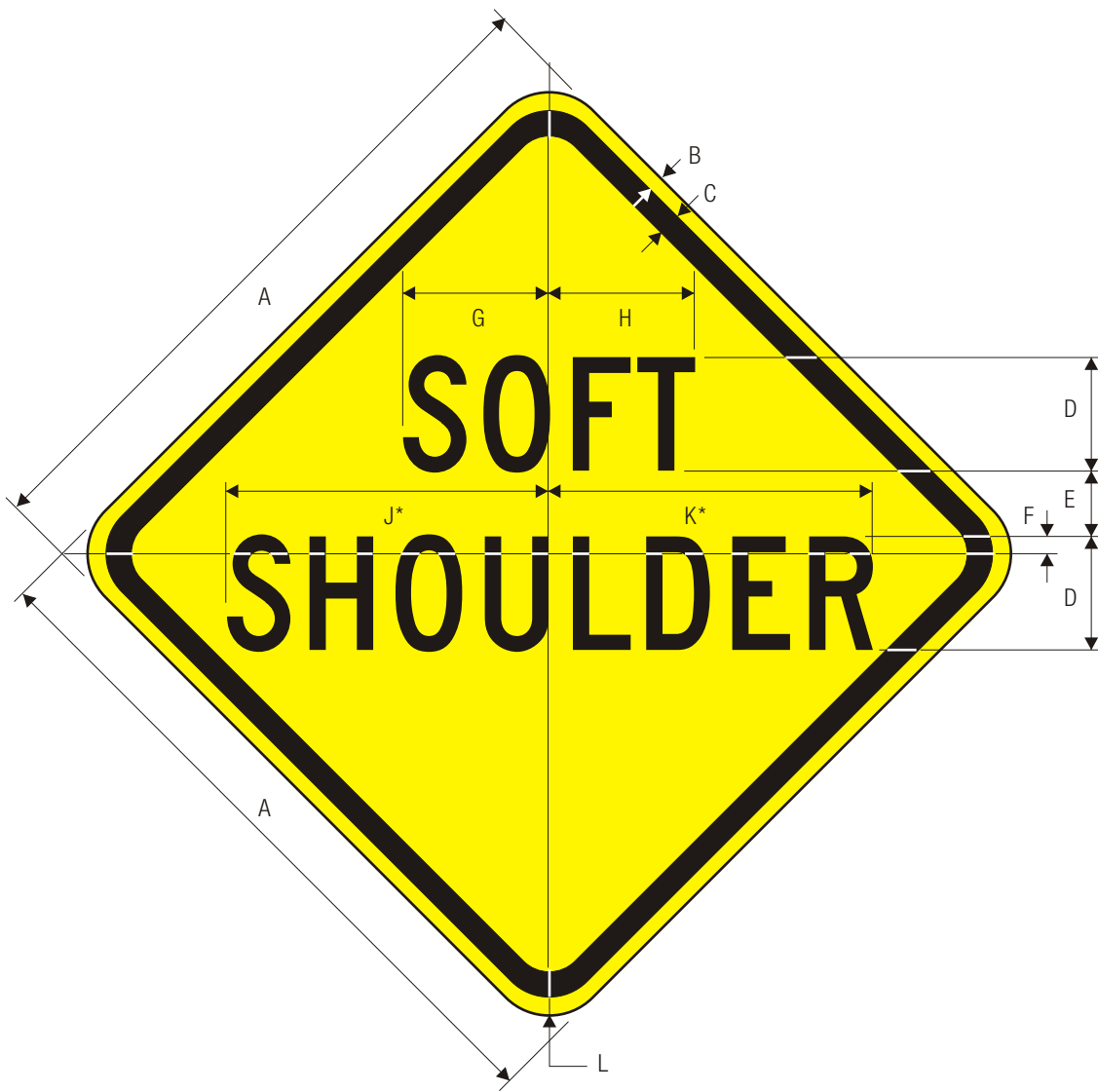

W8-4

SOFT SHOULDER

*Reduce spacing 25%.

A	B	C	D	E	F	G	H	J	K	L
24	.375	.625	4 C	2.5	.5	5.63	4.938	10.938	10.438	1.5
30	.5	.75	5 C	3	.75	7	6.125	13.688	13.063	1.875
36	.625	.875	6 C	3.5	1	8.375	7.375	16.5	15.75	2.25
48	.75	1.25	8 C	5	1.25	11.125	9.813	21.875	20.875	3

WARNING SIGN COLORS:

LEGEND — BLACK
BACKGROUND — YELLOW (RETROREFLECTIVE)

TTC SIGN COLORS:

LEGEND — BLACK
BACKGROUND — ORANGE (RETROREFLECTIVE)

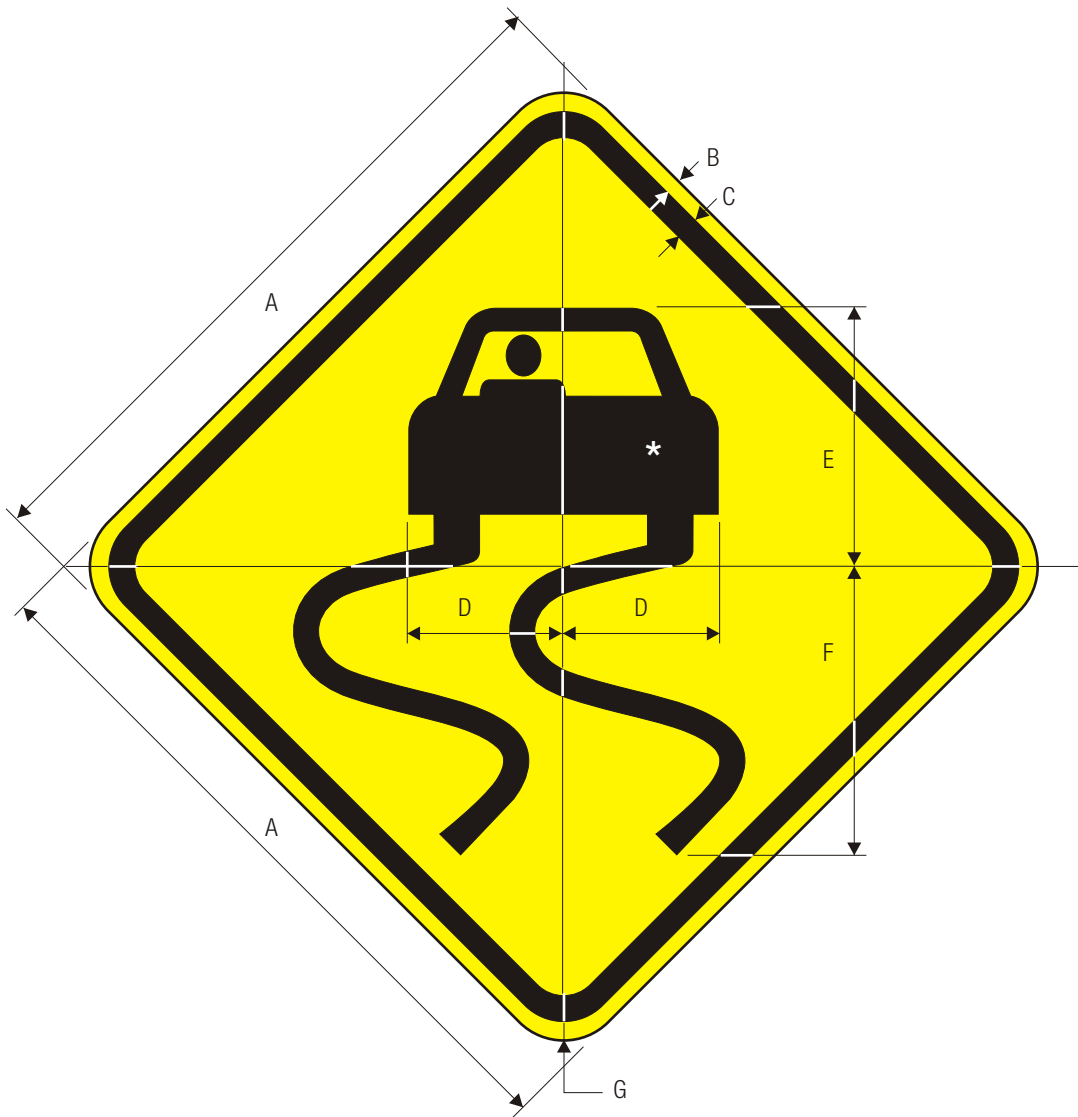

W8-5
SLIPPERY WHEN WET

*See page 6-23 for symbol design.

	A	B	C	D	E	F	G
	24	.375	.625	6.313	8.688	9.875	1.5
C	30	.5	.75	8	11	12.5	1.875
	36	.625	.875	9.5	13	14.813	2.25
	48	.75	1.25	12.625	17.375	19.75	3

WARNING SIGN COLORS:

SYMBOL — BLACK
BACKGROUND — YELLOW (RETROREFLECTIVE)

TTC SIGN COLORS:

SYMBOL — BLACK
BACKGROUND — ORANGE (RETROREFLECTIVE)

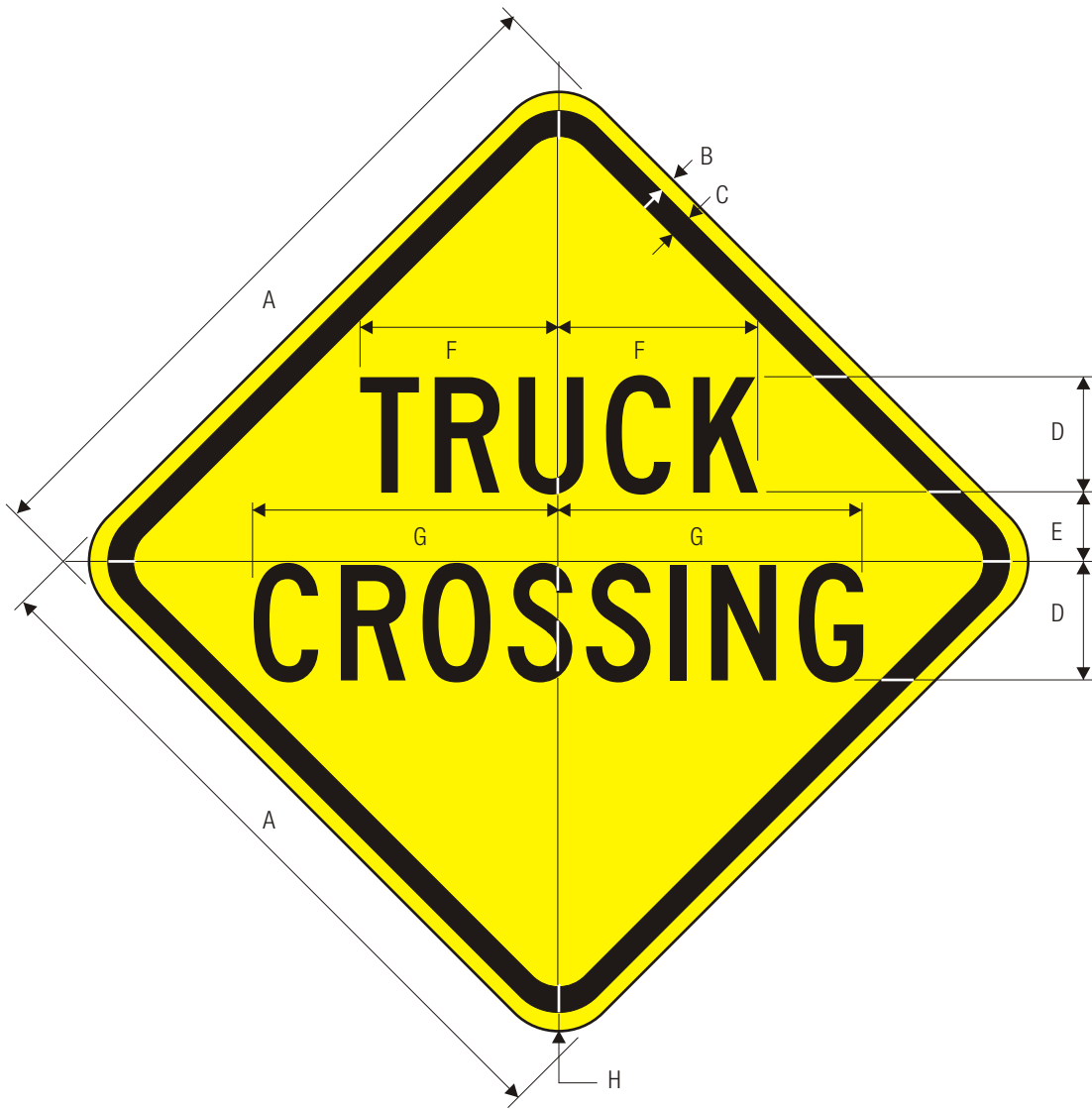

W8-6

TRUCK CROSSING

C

A	B	C	D	E	F	G	H
24	.375	.625	4 C	2.5	6.875	10.625	1.5
30	.5	.75	5 C	3	8.625	13.313	1.875
36	.625	.875	6 C	3.5	10.313	15.938	2.25
48	.75	1.25	8 C	5	13.75	21.25	3

WARNING SIGN COLORS:

LEGEND — BLACK
BACKGROUND — YELLOW (RETROREFLECTIVE)

TTC SIGN COLORS:

LEGEND — BLACK
BACKGROUND — ORANGE (RETROREFLECTIVE)

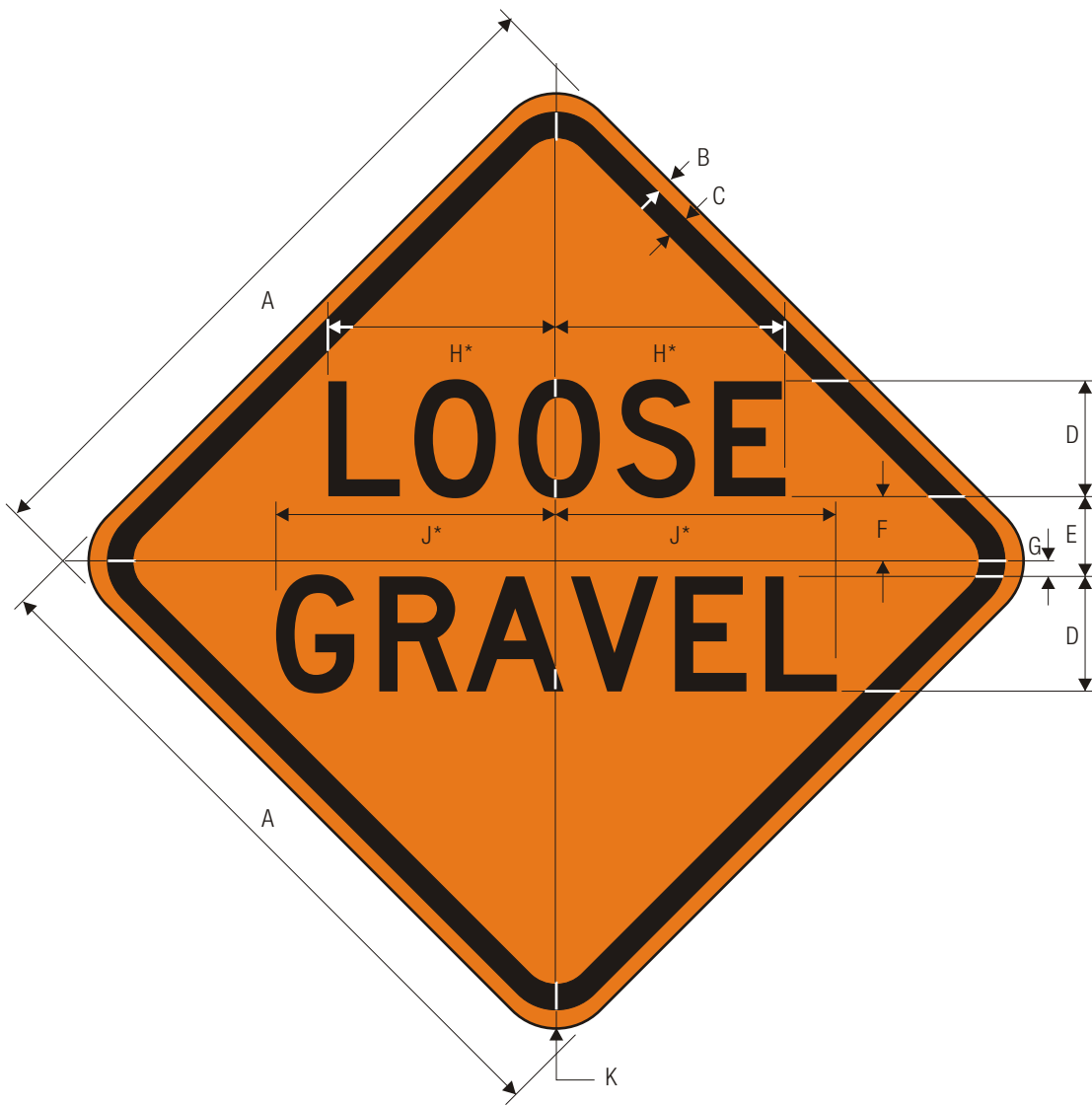

W8-7

LOOSE GRAVEL

*Reduce spacing 40%

	A	B	C	D	E	F	G	H	J	K
	24	.375	.625	4 D	2.75	2.25	.5	7.563	9.313	1.5
C	30	.5	.75	5 D	3.438	2.813	.625	9.438	11.688	1.875
	36	.625	.875	6 D	4.125	3.375	.75	11.313	14	2.25
	48	.75	1.25	8 D	5.5	4.5	1	15.125	18.688	3

WARNING SIGN COLORS:

LEGEND — BLACK
BACKGROUND — YELLOW (RETROREFLECTIVE)

TTC SIGN COLORS:

LEGEND — BLACK
BACKGROUND — ORANGE (RETROREFLECTIVE)

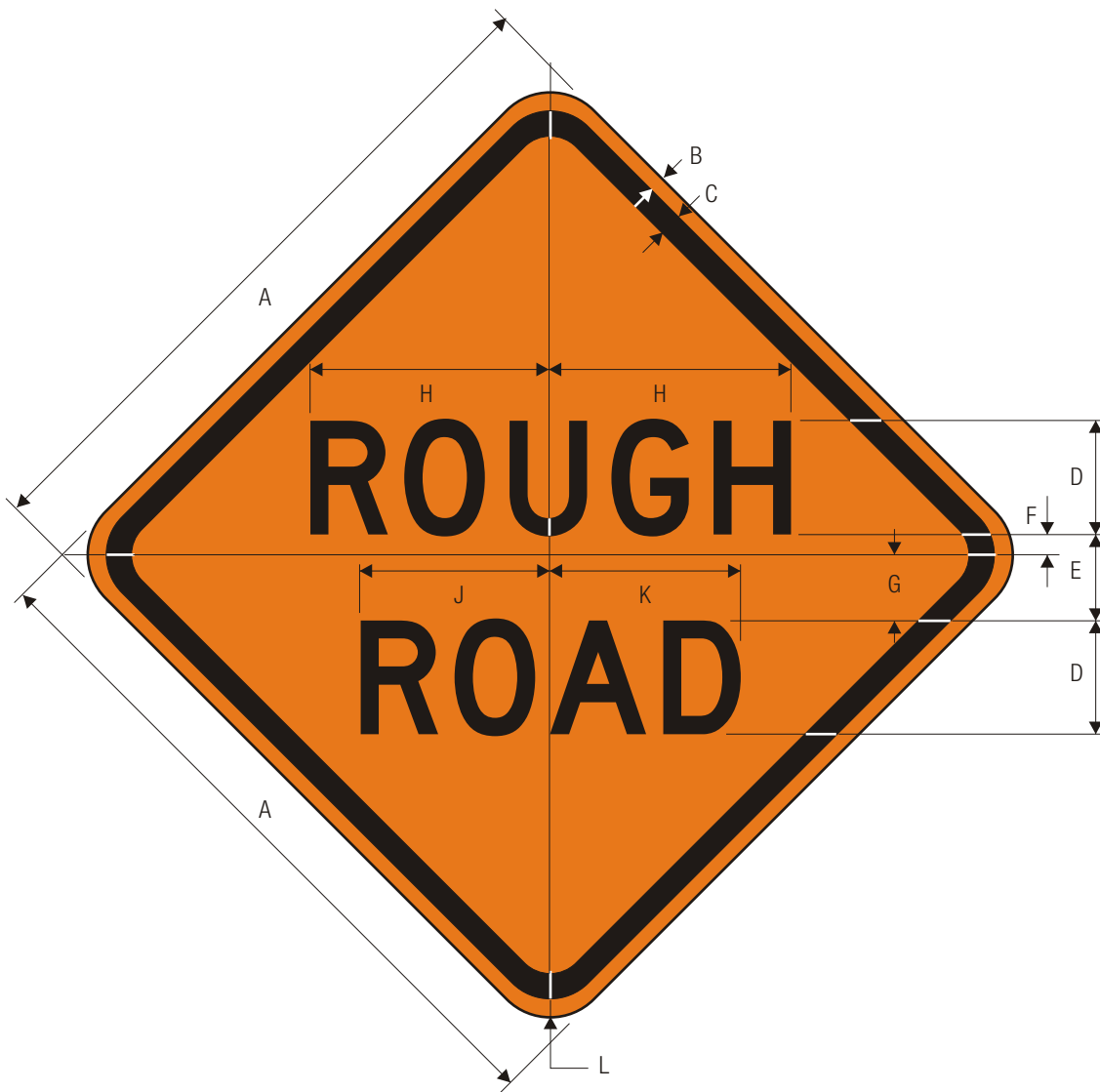

W8-8

LOOSE GRAVEL

C

A	B	C	D	E	F	G	H	J	K	L
24	.375	.625	4 D	3	.75	2.25	8.563	6.75	7	1.5
30	.5	.75	5 D	4	.875	3.125	10.688	8.438	8.75	1.875
36	.625	.875	6 D	5	1	4	12.875	10.125	10.5	2.25
48	.75	1.25	8 D	6	1.5	4.5	17.125	13.5	14	3

WARNING SIGN COLORS:

LEGEND — BLACK
 BACKGROUND — YELLOW (RETROREFLECTIVE)

TTC SIGN COLORS:

LEGEND — BLACK
 BACKGROUND — ORANGE (RETROREFLECTIVE)

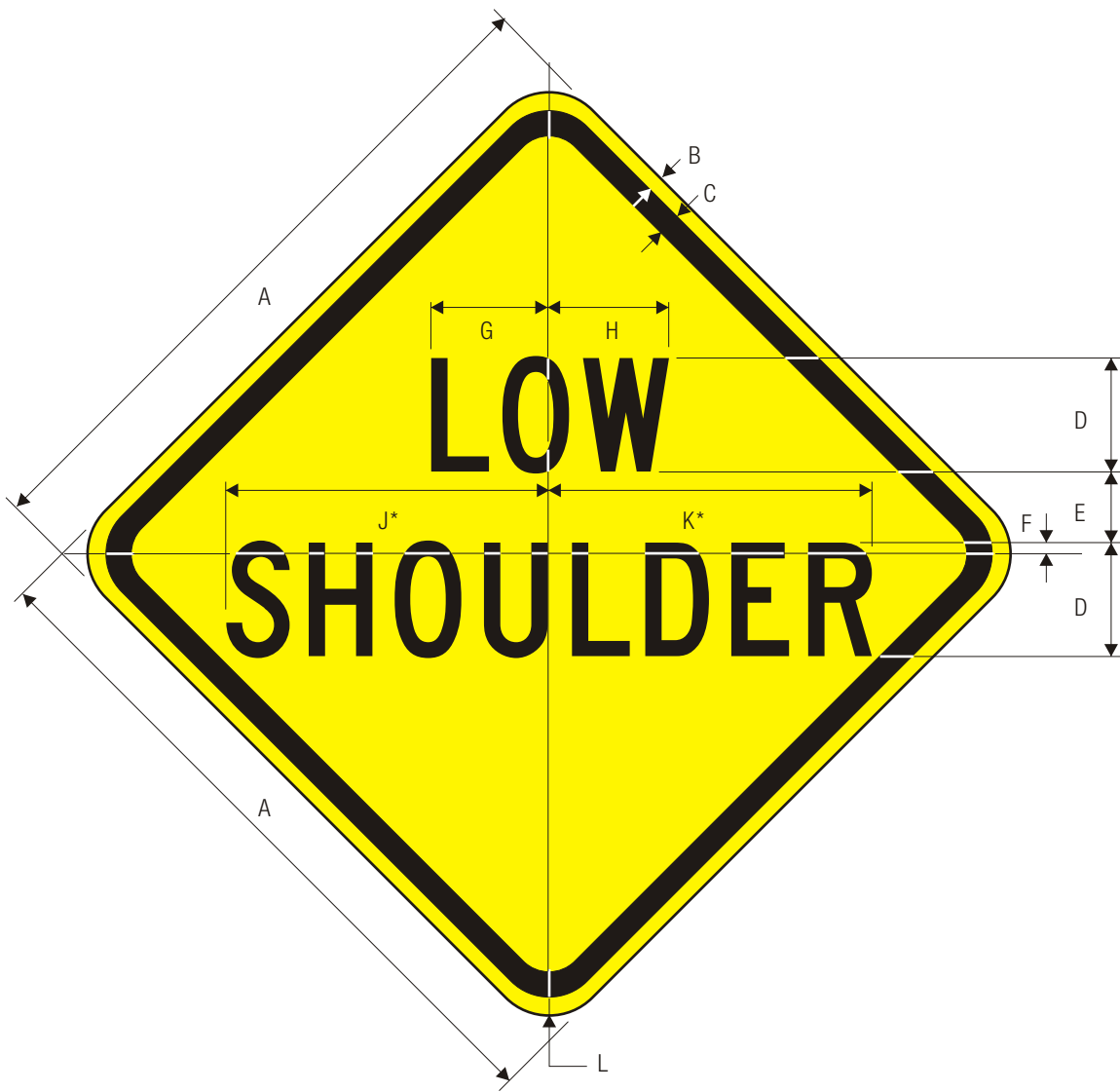

W8-9

LOW SHOULDER

	A	B	C	D	E	F	G	H	J	K	L
	24	.375	.625	4 C	2.25	.5	4.125	4.5	10.938	10.438	1.5
C	30	.5	.75	5 C	3	.75	5.188	5.625	13.688	13.063	1.875
	36	.625	.875	6 C	3.5	1	6.188	6.75	16.5	15.75	2.25
	48	.75	1.25	8 C	5	1.25	8.25	9	21.875	20.875	3

WARNING SIGN COLORS:

LEGEND — BLACK
 BACKGROUND — YELLOW (RETROREFLECTIVE)

TTC SIGN COLORS:

LEGEND — BLACK
 BACKGROUND — ORANGE (RETROREFLECTIVE)

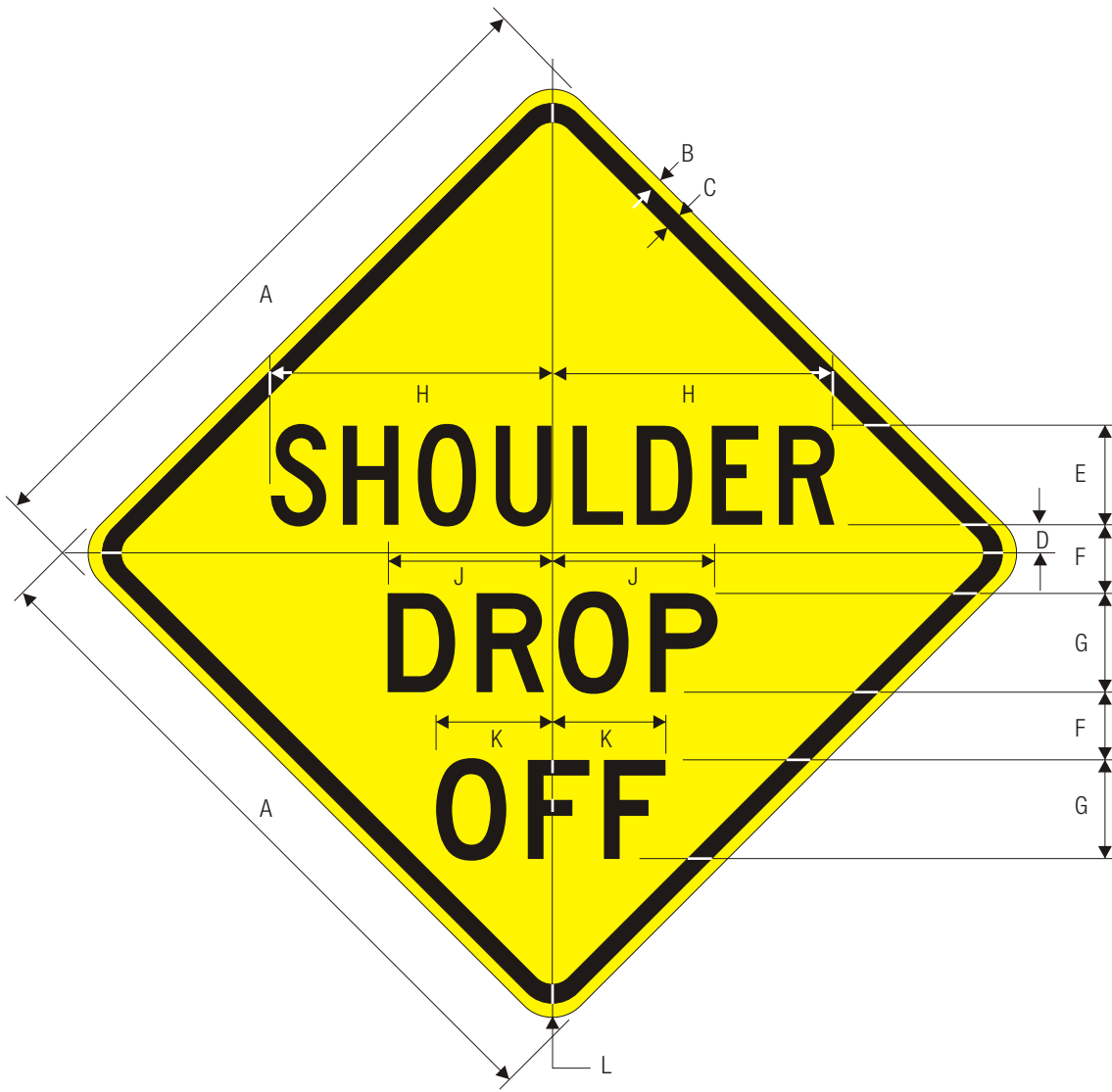

W8-9a

SHOULDER DROP OFF

C

A	B	C	D	E	F	G	H	J	K	L
24	.375	.625	1	3 C	2	3 D	8.526	4.992	3.472	1.5
30	.5	.75	1.5	4 C	3	4 D	11.368	6.655	4.628	1.875
36	.625	.875	1.625	5 C	4	5 D	14.230	8.318	5.785	2.25
48	.75	1.25	2	7 C	4.813	7 D	19.915	11.648	8.101	3

WARNING SIGN COLORS:

LEGEND — BLACK
 BACKGROUND — YELLOW (RETROREFLECTIVE)

TTC SIGN COLORS:

LEGEND — BLACK
 BACKGROUND — ORANGE (RETROREFLECTIVE)

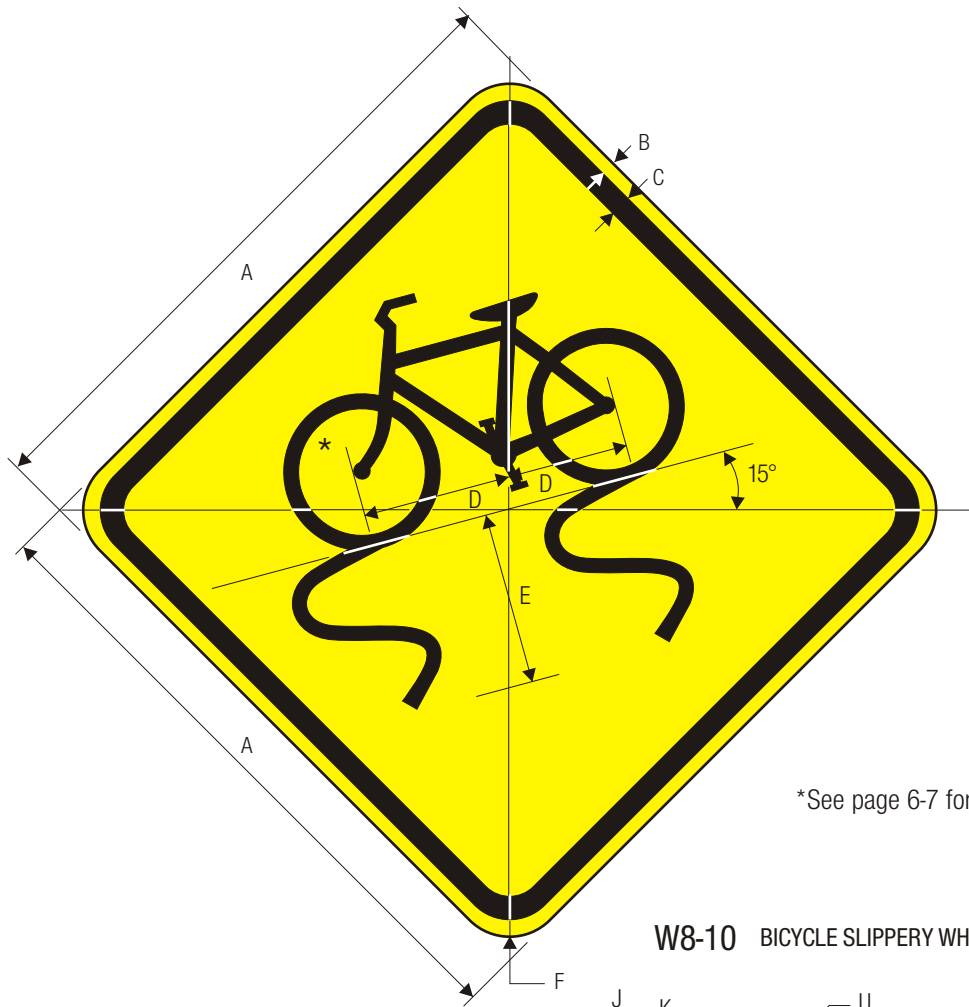

*See page 6-7 for symbol design.

W8-10 BICYCLE SLIPPERY WHEN WET



W8-10a

BICYCLE SLIPPERY WHEN WET PLAQUE

**Reduce spacing 25%

A	B	C	D	E	F	G	H	J	K	L	M
18	.375	.625	3.625	4.657	1.5	12	9	.375	.375	2	2 C
24	.375	.625	4.833	6.209	1.5	24	18	.375	.625	4	4 C

N	P	Q	R	S	T	U
1.5	1.5 C	5	5.25	4.625	4.25	1.5
3	3 C	10	10.375	9	8.625	1.5

COLORS: LEGEND — BLACK
BACKGROUND — YELLOW (RETROREFLECTIVE)

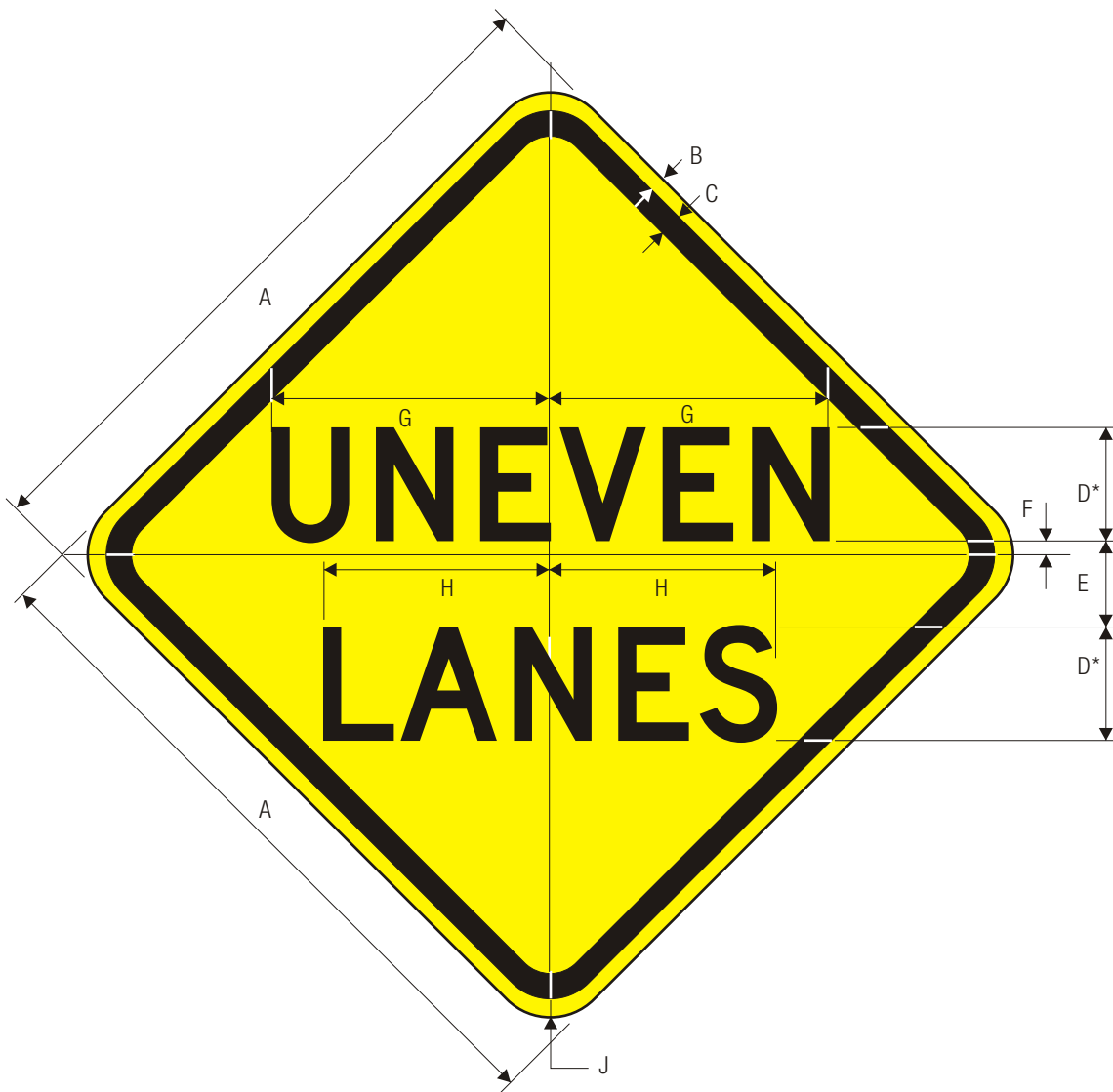

W8-11
UNEVEN LANES

*Series 2000 Standard Alphabets.

	A	B	C	D	E	F	G	H	J
	24	.375	.625	4 D	3	.640	9.807	7.986	1.5
C	30	.5	.75	5 D	3.762	.800	12.249	9.967	1.875
	36	.625	.875	6 D	4.523	.960	14.711	11.969	2.25
	48	.75	1.25	8 D	6	1.280	19.614	15.952	3

WARNING SIGN COLORS:

LEGEND — BLACK
BACKGROUND — YELLOW (RETROREFLECTIVE)

TTC SIGN COLORS:

LEGEND — BLACK
BACKGROUND — ORANGE (RETROREFLECTIVE)



W8-12
NO CENTER STRIPE

*Series 2000 Standard Alphabets.

	A	B	C	D	E	F	G	H	J	K
	24	.375	.625	4 D	2.802	.560	3.202	9.487	8.426	1.5
C	30	.5	.75	5 D	3.482	.680	4	11.869	10.528	1.875
	36	.625	.875	6 D	4.203	.800	4.803	14.230	12.649	2.25
	48	.75	1.25	8 D	4.563	1.080	6.424	18.974	16.852	3

WARNING SIGN COLORS:
LEGEND — BLACK
BACKGROUND— YELLOW (RETROREFLECTIVE)

TTC SIGN COLORS:
LEGEND — BLACK
BACKGROUND— ORANGE (RETROREFLECTIVE)



W8-13

BRIDGE ICES BEFORE ROAD

*Series 2000 Standard Alphabets.

	A	B	C	D	E	F	G	H	J	K
C	30	.5	.75	4 C	2	2	7.625	14	5.504	1.875
	36	.625	.875	5 C	2.481	2.481	9.527	17.493	6.885	2.25
	48	.75	1.25	6 C	3	3	11.448	20.995	8.266	3

WARNING SIGN COLORS:

LEGEND — BLACK
 BACKGROUND — YELLOW (RETROREFLECTIVE)

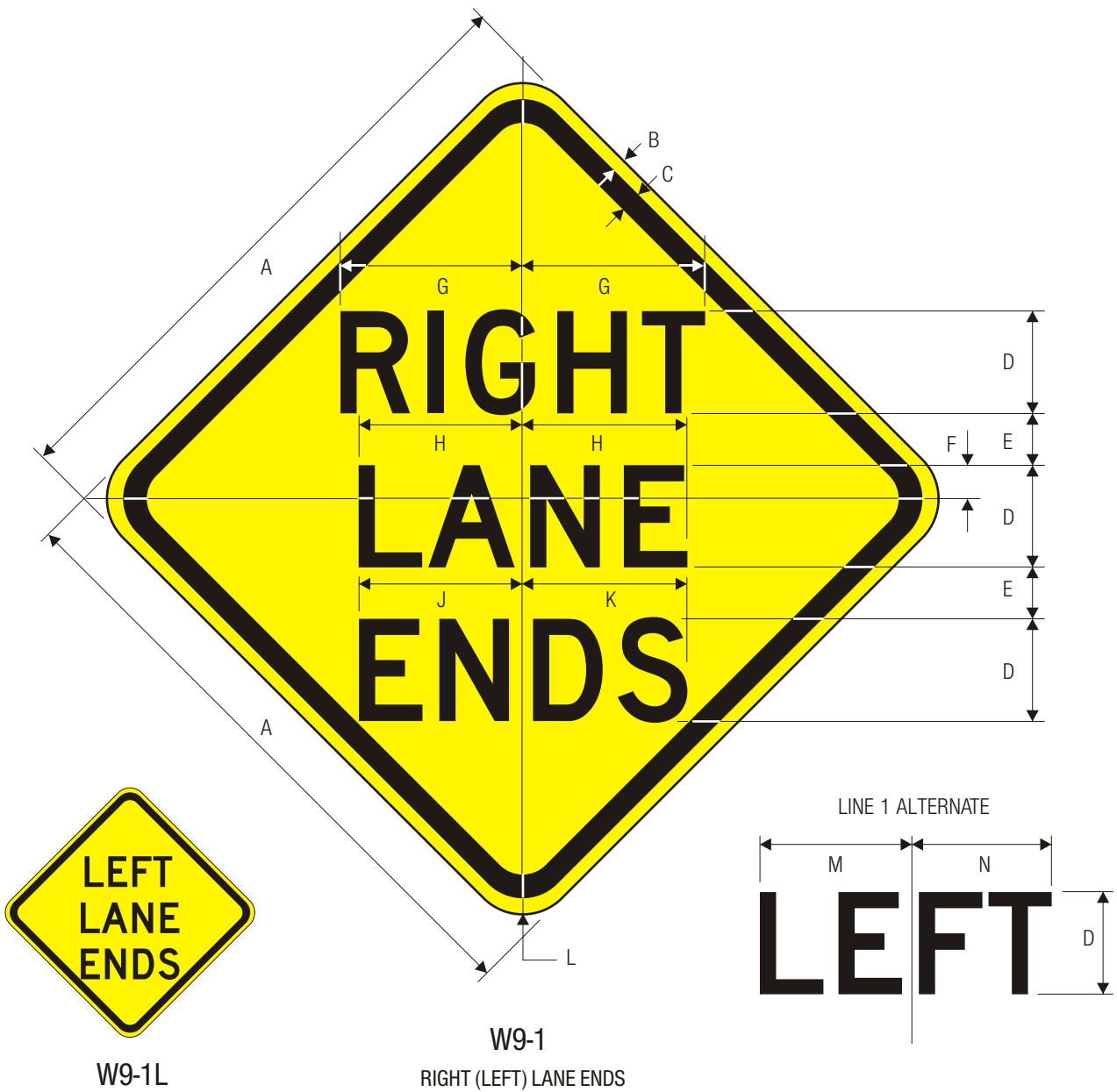

A	B	C	D	E	F	G	H	J	K	L
24	.375	.625	4 D	2	1.5	7.375	6.438	6.125	6.813	1.5
30	.5	.75	5 D	2.5	1.5	9.188	8.063	7.625	8.563	1.875
36	.625	.875	6 D	3	2	11	9.688	9	10.375	2.25
48	.75	1.25	8 D	4	3	14.75	12.875	12.25	13.625	3

M	N
5.75	6
7.125	7.563
8.5	9.125
11.25	12.25

WARNING SIGN COLORS:
 LEGEND — BLACK
 BACKGROUND— YELLOW (RETROREFLECTIVE)

TTC SIGN COLORS:
 LEGEND — BLACK
 BACKGROUND— ORANGE (RETROREFLECTIVE)

C

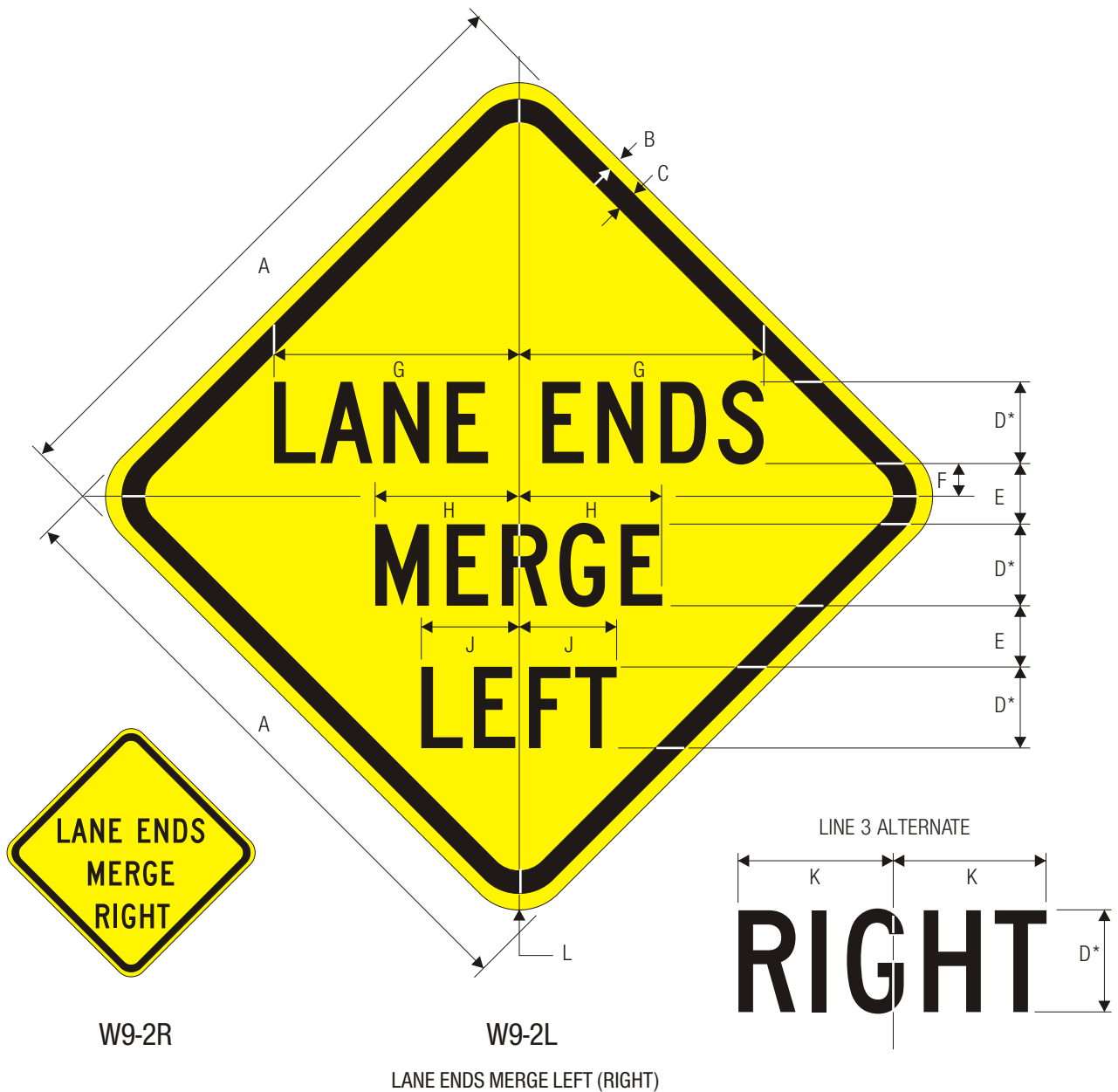

*Series 2000 Standard Alphabets.

	A	B	C	D	E	F	G	H	J	K	L
C	30	.5	.75	4 C	3	1.688	12.020	7.048	4.797	6.052	1.875
	36	.625	.875	5 C	3.75	2	15.026	8.811	5.996	7.566	2.25
	48	.75	1.25	6 C	4.5	2.4	18.033	10.573	7.196	9.079	3

WARNING SIGN COLORS:
 LEGEND — BLACK
 BACKGROUND— YELLOW (RETROREFLECTIVE)

TTC SIGN COLORS:
 LEGEND — BLACK
 BACKGROUND— ORANGE (RETROREFLECTIVE)

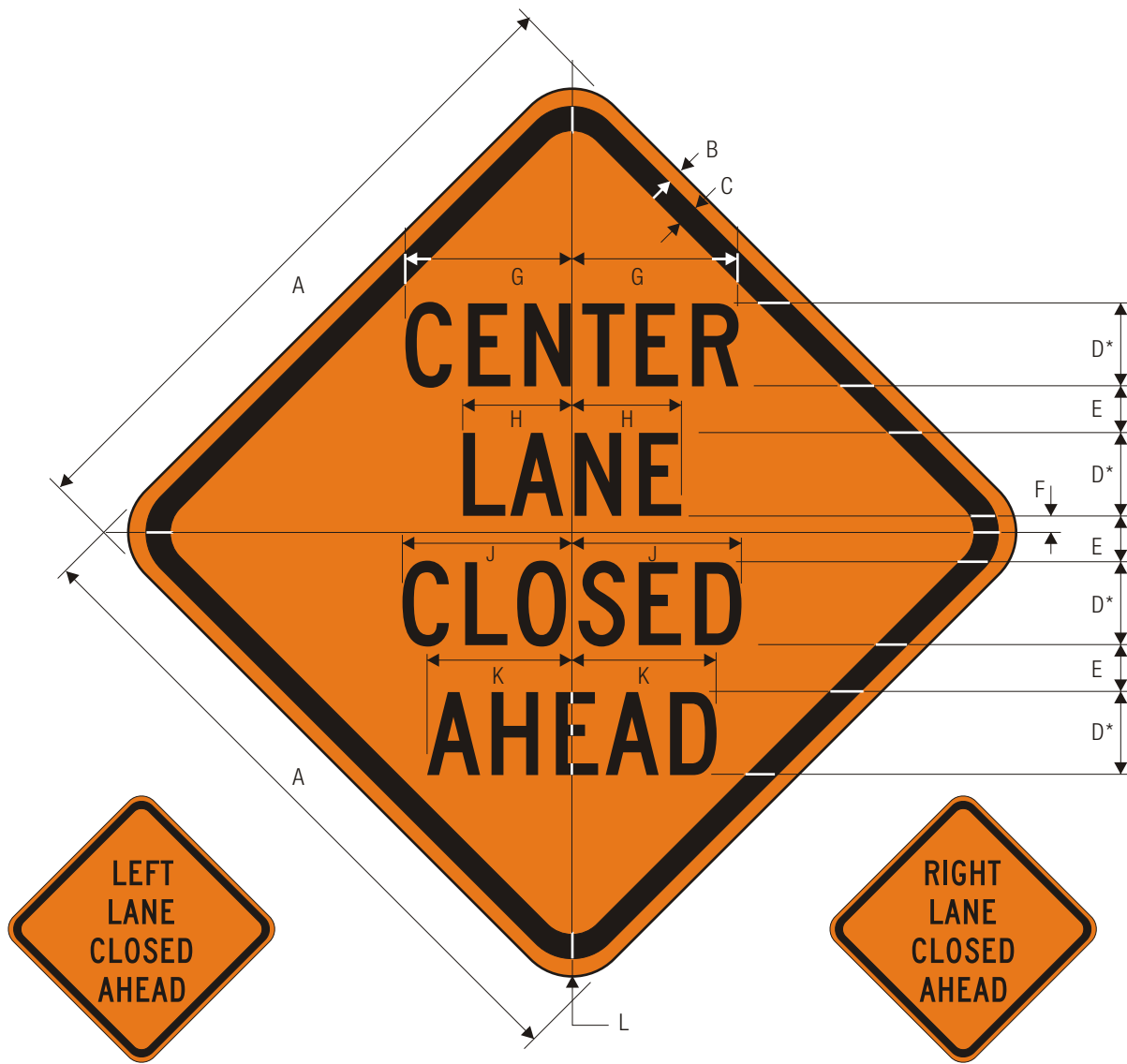

W9-3L

W9-3

W9-3R

CENTER (RIGHT) (LEFT) LANE CLOSED AHEAD

*Series 2000 Standard Alphabets.

	A	B	C	D	E	F	G	H	J	K	L
	30	.5	.75	4 C	2.241	.880	8.026	5.263	8.166	6.985	1.875
C	36	.625	.875	5 C	2	.680	10.027	6.564	10.207	8.726	2.25
	48	.75	1.25	6 C	4.523	1.080	12.049	7.885	12.249	10.467	3
	60	.75	1.25	8 C	5.203	1.641	16.052	10.507	16.332	13.950	3

TTC SIGN COLORS:
 LEGEND — BLACK
 BACKGROUND— ORANGE (RETROREFLECTIVE)

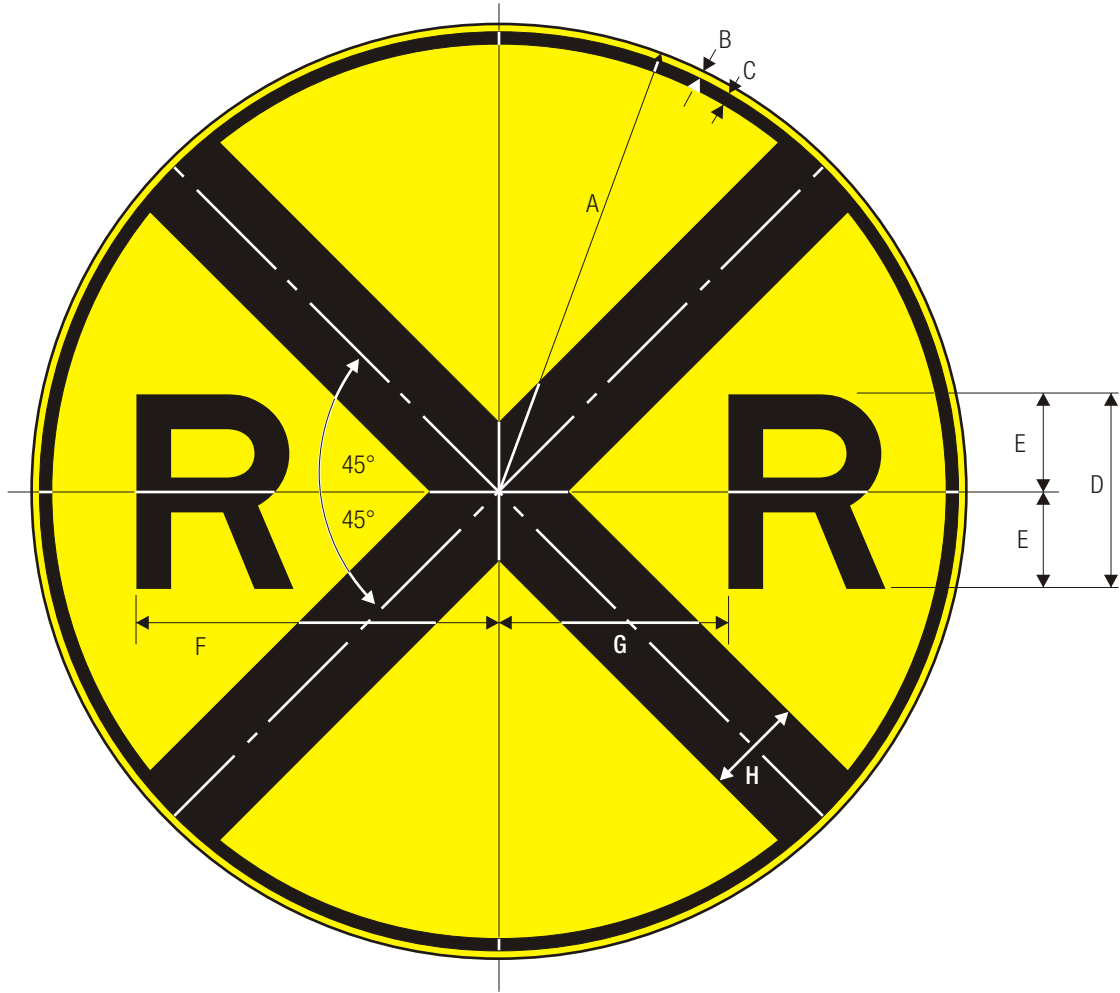

W10-1

HIGHWAY-RAIL GRADE CROSSING ADVANCE WARNING

C

A	B	C	D	E	F	G	H
9	.25	.375	4 E	2	7.187	4.312	2
12	.375	.625	5 E	2.5	9.187	5.812	2.5
15	.375	.625	7 E	3.5	12.375	7.125	3
18	.5	.75	8 E	4	14.375	8.625	4
24	.75	1.25	10 E	5	18.375	11.625	5

COLORS: LEGEND — BLACK
 BACKGROUND— YELLOW (RETROREFLECTIVE)

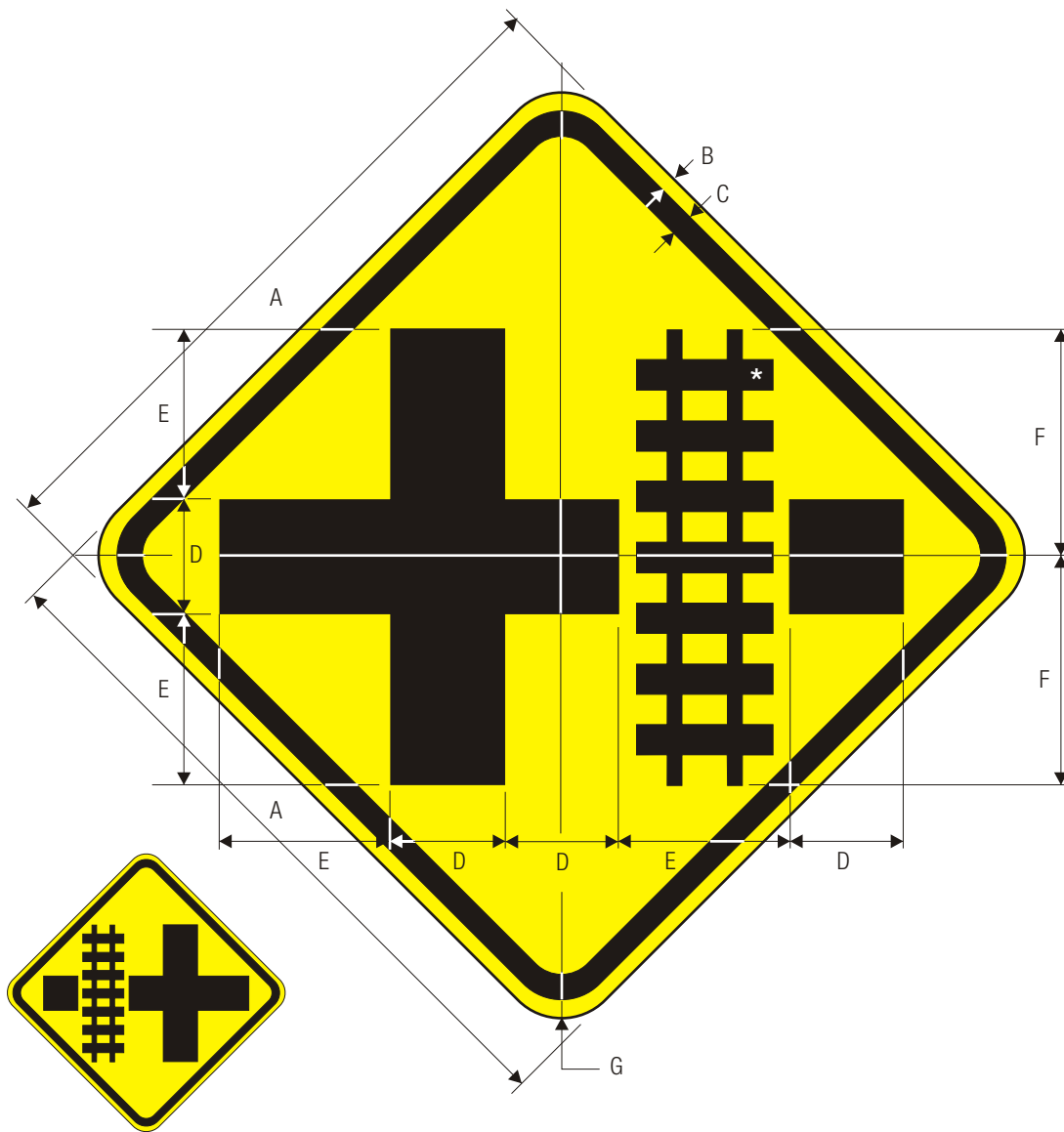

W10-2L

W10-2R

HIGHWAY-RAIL GRADE CROSSING ADVANCE WARNING

*See page 6-24 for symbol design.

	A	B	C	D	E	F	G
	18	.375	.625	3	4.483	6	1.5
	24	.375	.625	4	6	8	1.5
	30	.5	.75	5	7.485	10	1.875
C	36	.625	.875	6	9	12	2.25
	48	.75	1.25	8	12	16	3

COLORS: LEGEND — BLACK
 BACKGROUND — YELLOW (RETROREFLECTIVE)

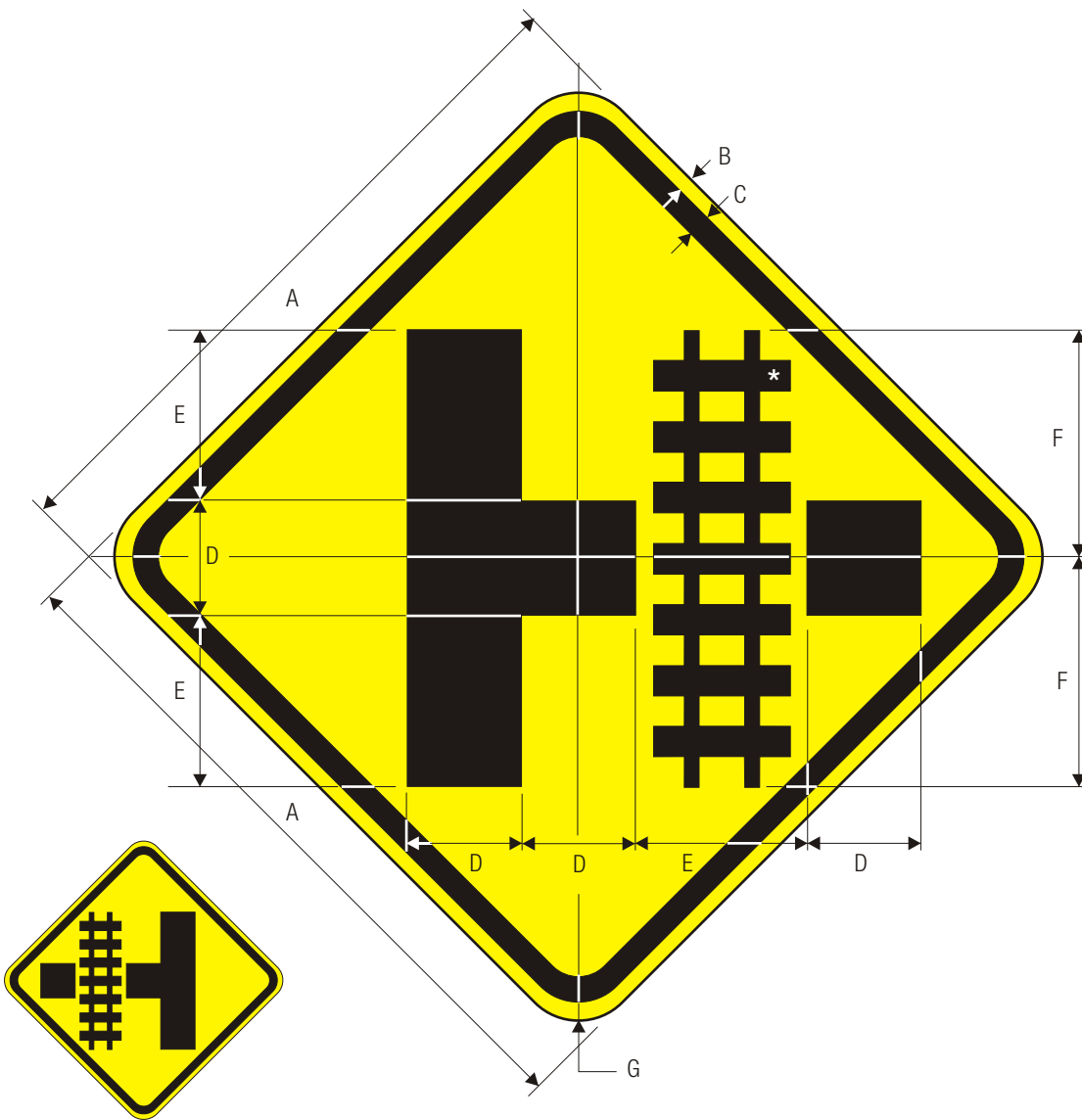

W10-3L

W10-3R

HIGHWAY-RAIL GRADE CROSSING ADVANCE WARNING

*See page 6-24 for symbol design.

	A	B	C	D	E	F	G
	18	.375	.625	3	4.483	6	1.5
	24	.375	.625	4	6	8	1.5
	30	.5	.75	5	7.485	10	1.875
C	36	.625	.875	6	9	12	2.25
	48	.75	1.25	8	12	16	3

COLORS: LEGEND — BLACK
 BACKGROUND — YELLOW (RETROREFLECTIVE)

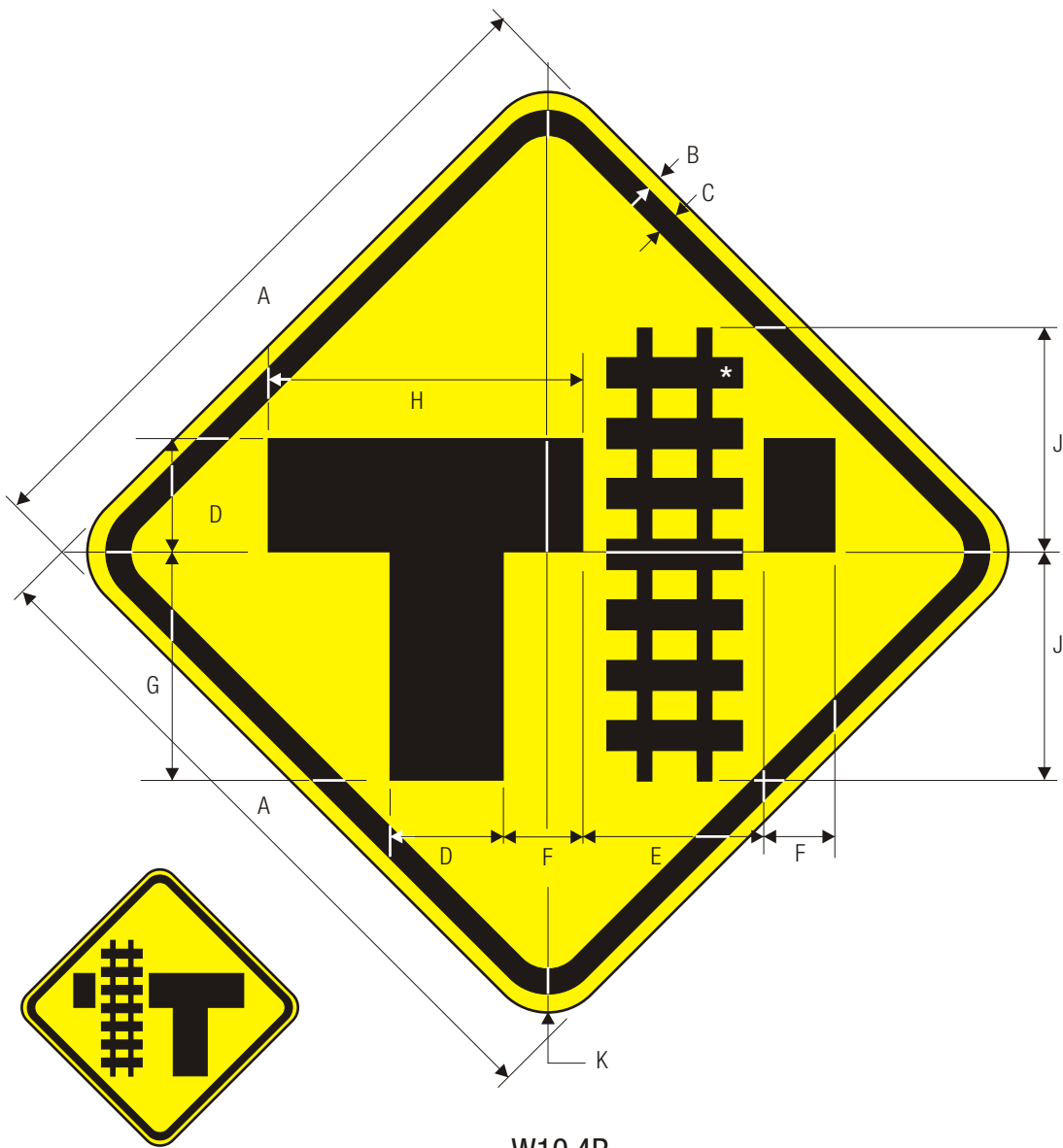

W10-4R

W10-4L

HIGHWAY-RAIL GRADE CROSSING ADVANCE WARNING

*See page 6-24 for symbol design.

	A	B	C	D	E	F	G	H	J	K
	18	.375	.625	3	4.483	2	6	8.486	6	1.5
	24	.375	.625	4	6	2.722	8	11.448	8	1.5
	30	.5	.75	5	7.485	3.442	10	14.410	10	1.875
C	36	.625	.875	6	9	4	12	17	12	2.25
	48	.75	1.25	8	12	5	16	22	16	3

COLORS: LEGEND — BLACK
 BACKGROUND — YELLOW (RETROREFLECTIVE)

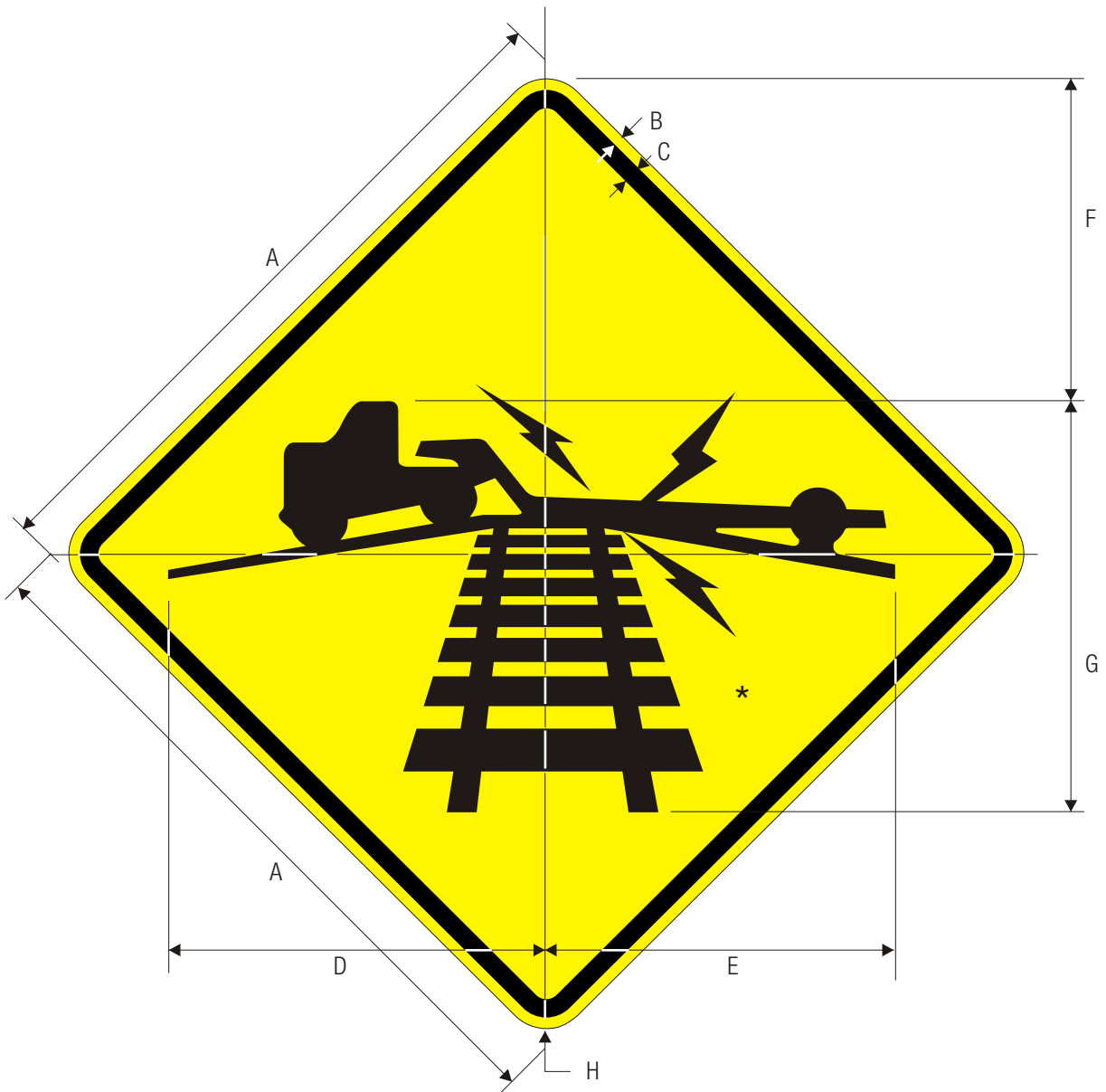

W10-5

LOW GROUND CLEARANCE HIGHWAY-RAIL GRADE CROSSING

*See page 6-13 for symbol design.

A	B	C	D	E	F	G	H
24	.375	.625	12.889	12.449	10.848	14.290	1.5
30	.5	.75	15.691	15.251	13.410	17.533	1.875
36	.625	.875	19.294	18.894	15.451	21.616	2.25
48	.75	1.25	24.858	24.458	20.615	27.861	3

COLORS: SYMBOL BLACK
BACKGROUND YELLOW (RETROREFLECTIVE)

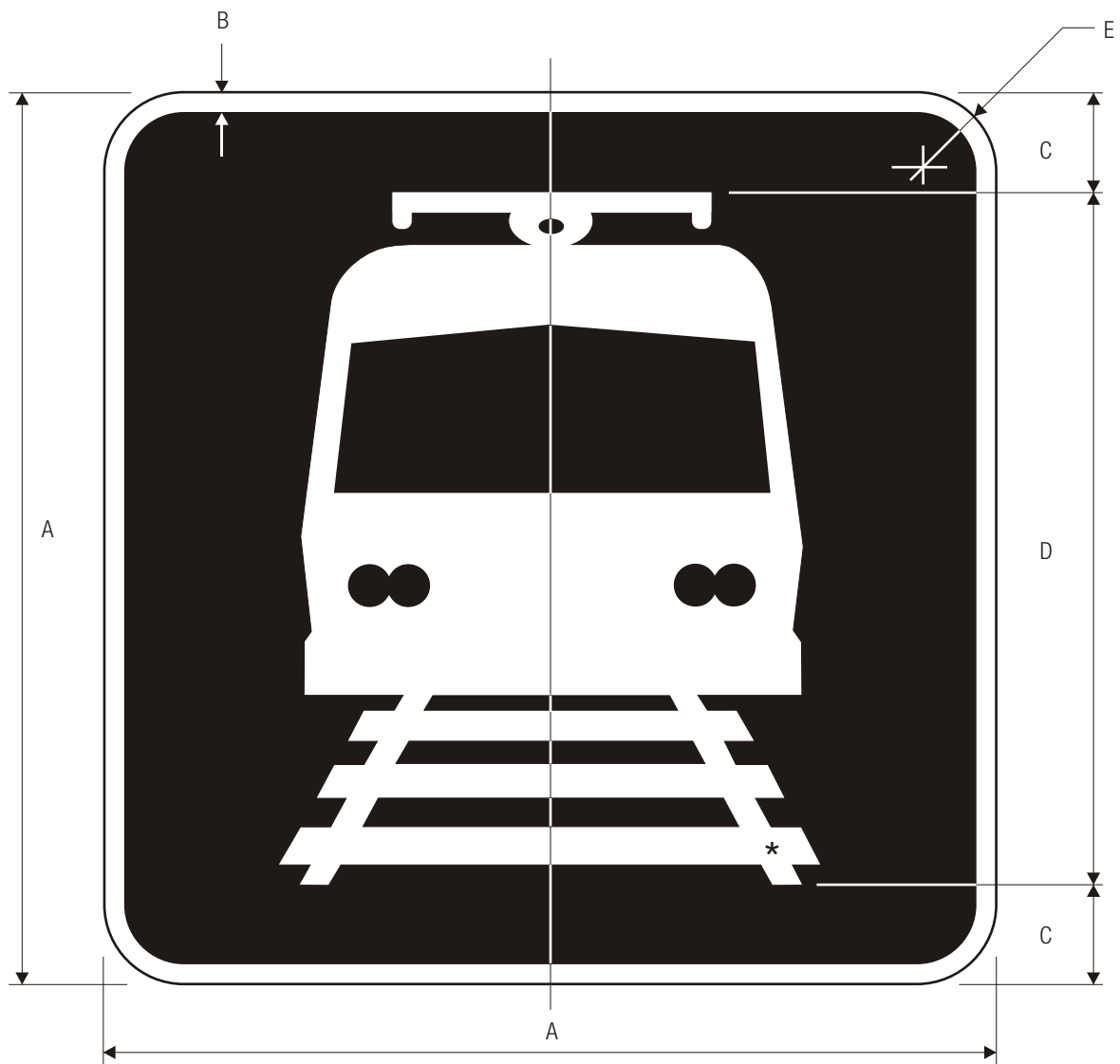

W10-7

LIGHT RAIL ACTIVATED BLANK-OUT SYMBOL

*See page 6-17 for symbol design.

	A	B	C	D	E
C	24	.5	2.5	19	1.5
	30	.75	3	24	1.875
	36	.75	3.5	29	2.25

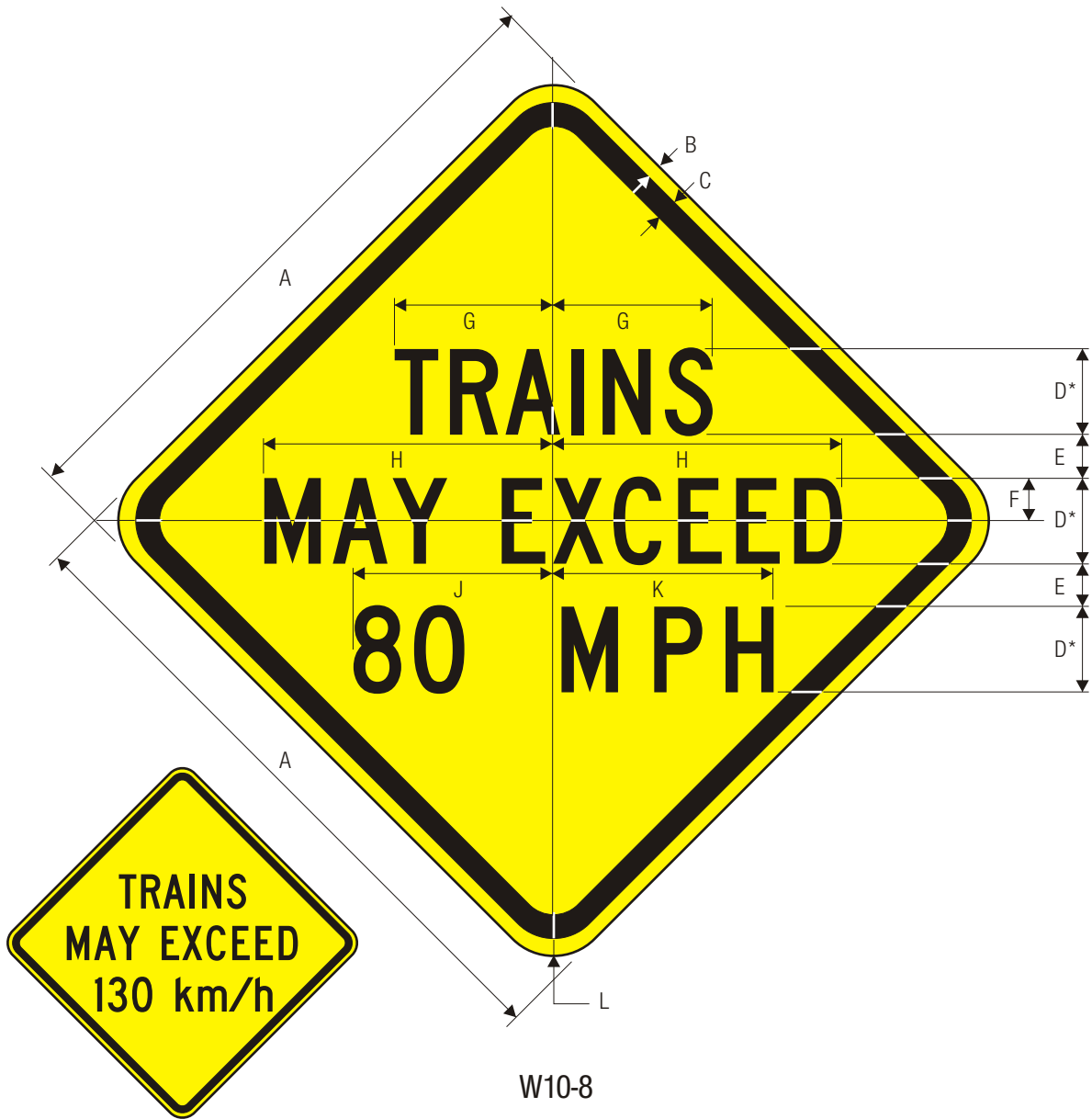

TRAINS MAY EXCEED XX MPH

*Series 2000 Standard Alphabets.

A	B	C	D	E	F	G	H	J	K	L
30	.5	.75	4 C	2	2	7.425	13.490	VAR	VAR	1.875
C 36	.625	.875	5 C	2.481	2.481	9.287	16.872	VAR	VAR	2.25
48	.75	1.25	6 C	3	3	11.148	20.255	VAR	VAR	3

COLORS: LEGEND — BLACK
 BACKGROUND — YELLOW (RETROREFLECTIVE)

FOR USE WITH W10-1



W10-9

NO TRAIN HORN

*Series 2000 Standard Alphabets.

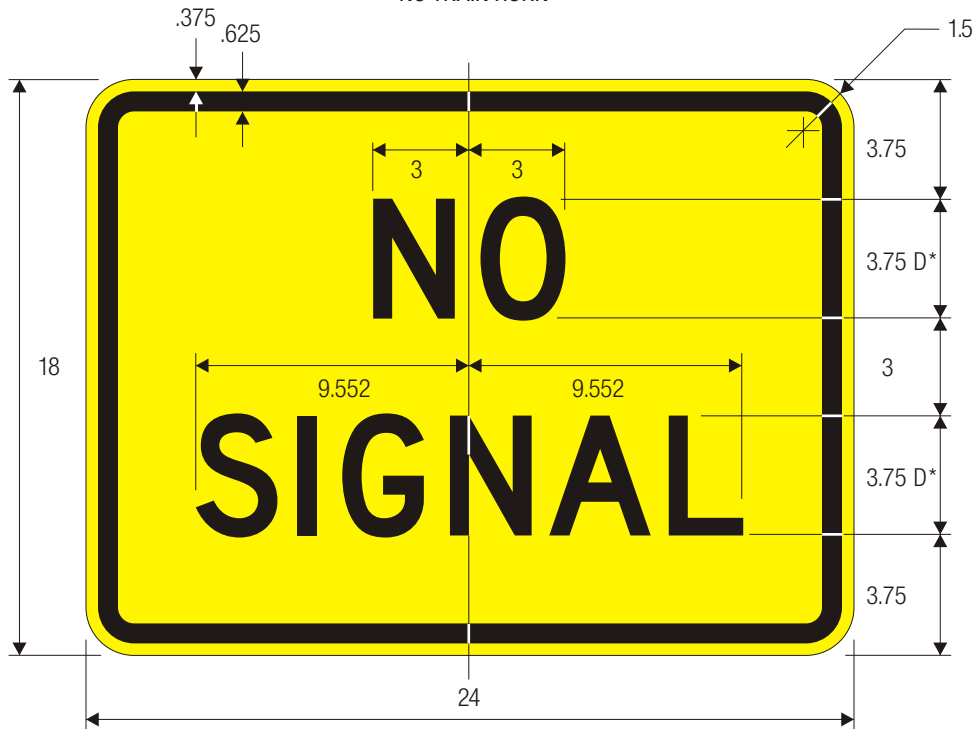

W10-10

NO SIGNAL

COLORS: LEGEND — BLACK
BACKGROUND — YELLOW (RETROREFLECTIVE)

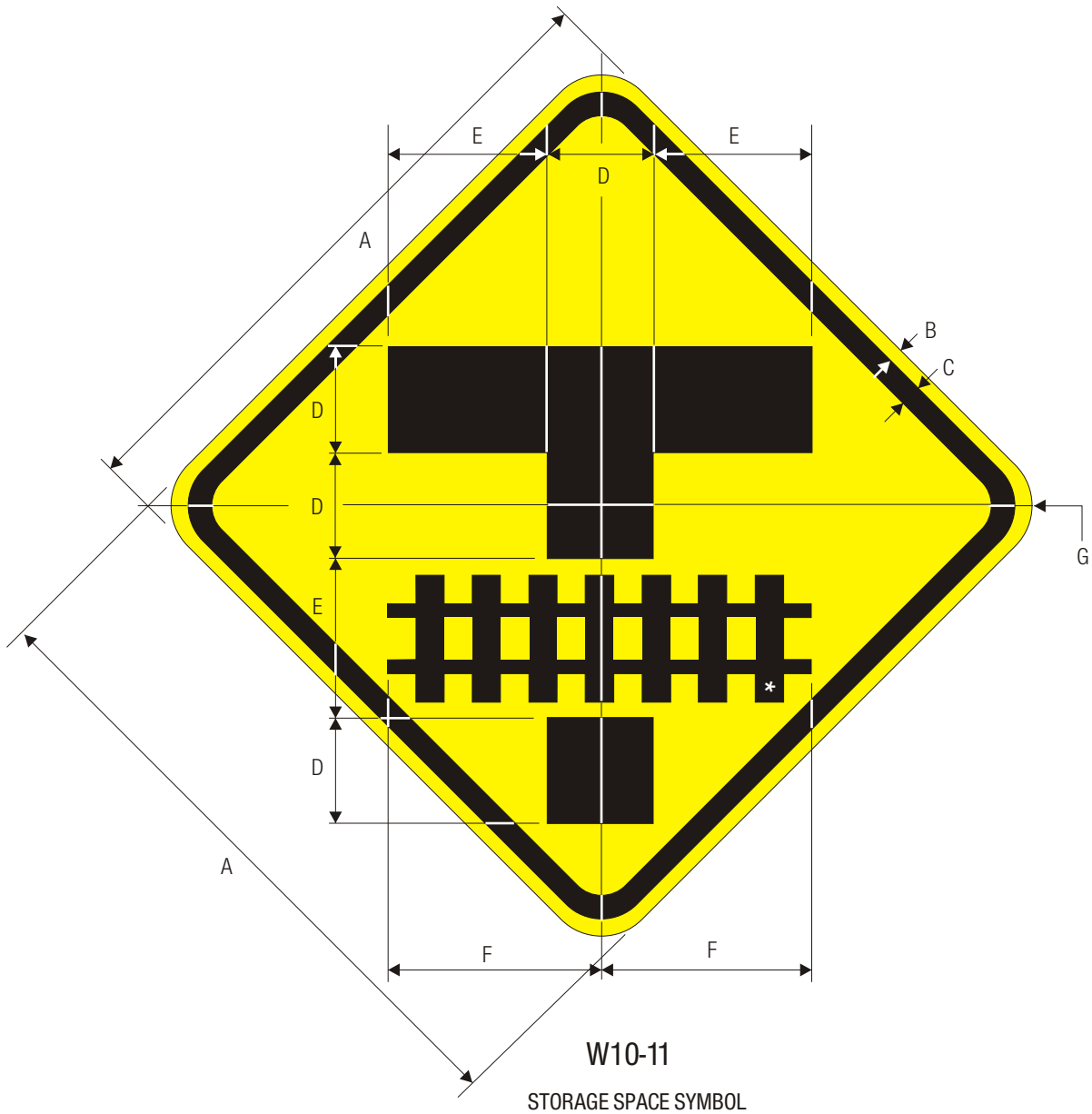

*See page 6-24 for symbol design.

	A	B	C	D	E	F	G
	18	.375	.625	3	4.483	6	1.5
	24	.375	.625	4	6	8	1.5
	30	.5	.75	5	7.485	10	1.875
C	36	.625	.875	6	9	12	2.25
	48	.75	1.25	8	12	16	3

COLORS: LEGEND — BLACK
BACKGROUND — YELLOW (RETROREFLECTIVE)



*Series 2000 Standard Alphabets.

W10-11a

STORAGE SPACE XX FEET (ENGLISH)

COLORS: LEGEND — BLACK
 BACKGROUND — YELLOW (RETROREFLECTIVE)

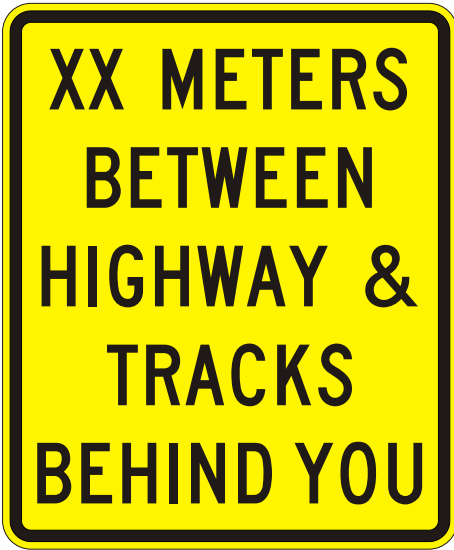

*Series 2000 Standard Alphabets.

W10-11b

STORAGE SPACE XX FEET (ENGLISH)

COLORS: LEGEND — BLACK
 BACKGROUND — YELLOW (RETROREFLECTIVE)

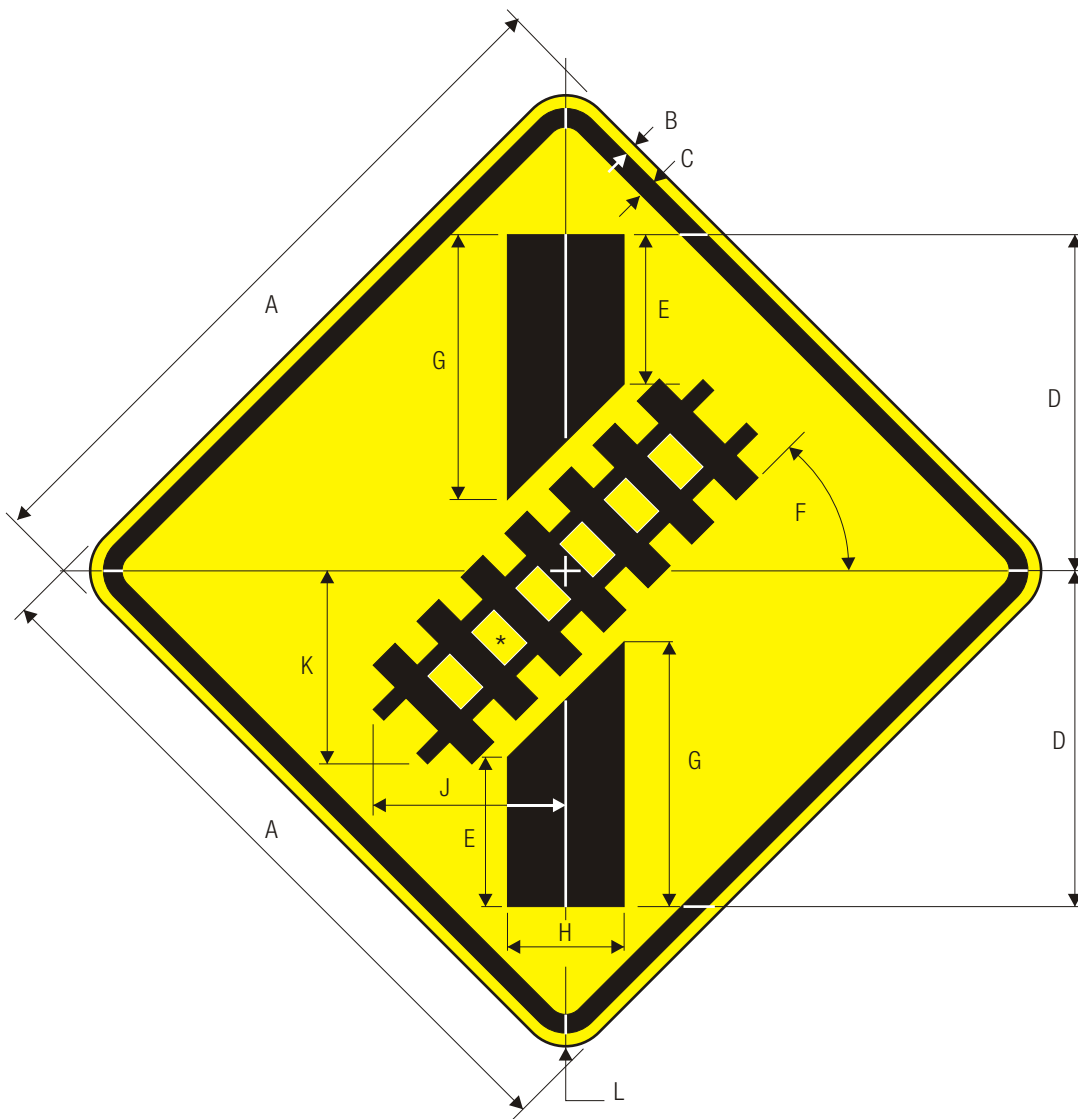

W10-12

SKEWED CROSSING

*See page 6-24 for symbol design.

A	B	C	D	E	F	G	H	J	K	L
18	.375	.625	8.646	3.802	45°	6.805	3	4.923	4.963	1.5
24	.375	.625	11.528	5.083	45°	9.086	4	6.564	6.645	1.5
30	.5	.75	14.410	6.364	45°	11.368	5	8.206	8.286	1.875
36	.625	.875	17.293	7.645	45°	13.650	6	9.847	9.927	2.25
48	.75	1.25	23.057	10.167	45°	18.173	8	13.129	13.250	3

C

COLORS: LEGEND — BLACK
 BACKGROUND— YELLOW (RETROREFLECTIVE)

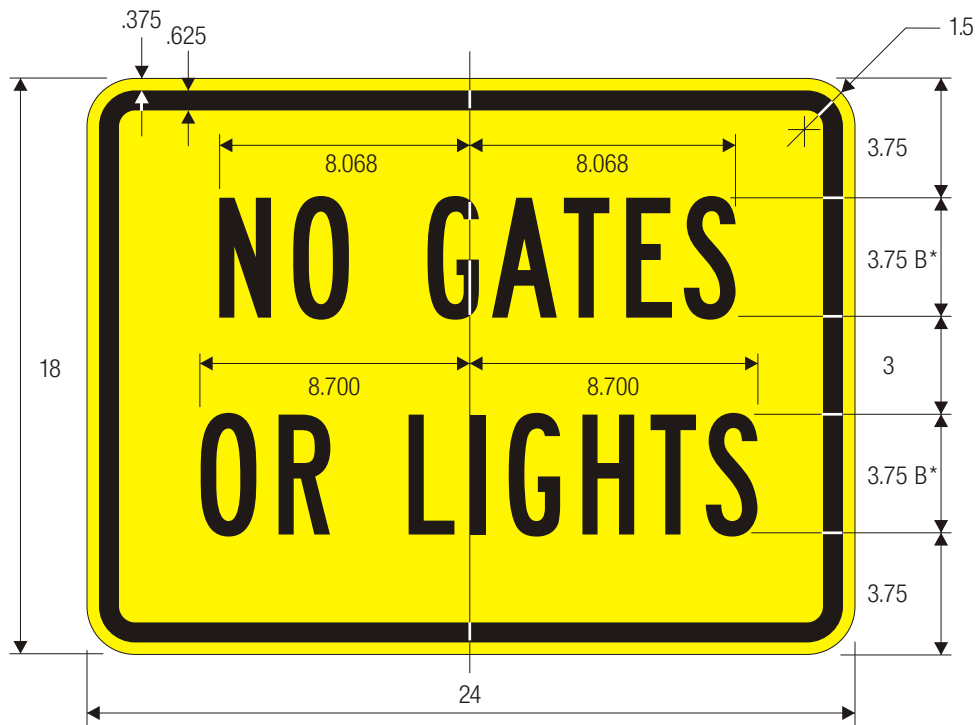

For use with W10-1

W10-13

*Series 2000 Standard Alphabets.

NO GATES OR LIGHTS

COLORS: LEGEND — BLACK
 BACKGROUND — YELLOW (RETROREFLECTIVE)

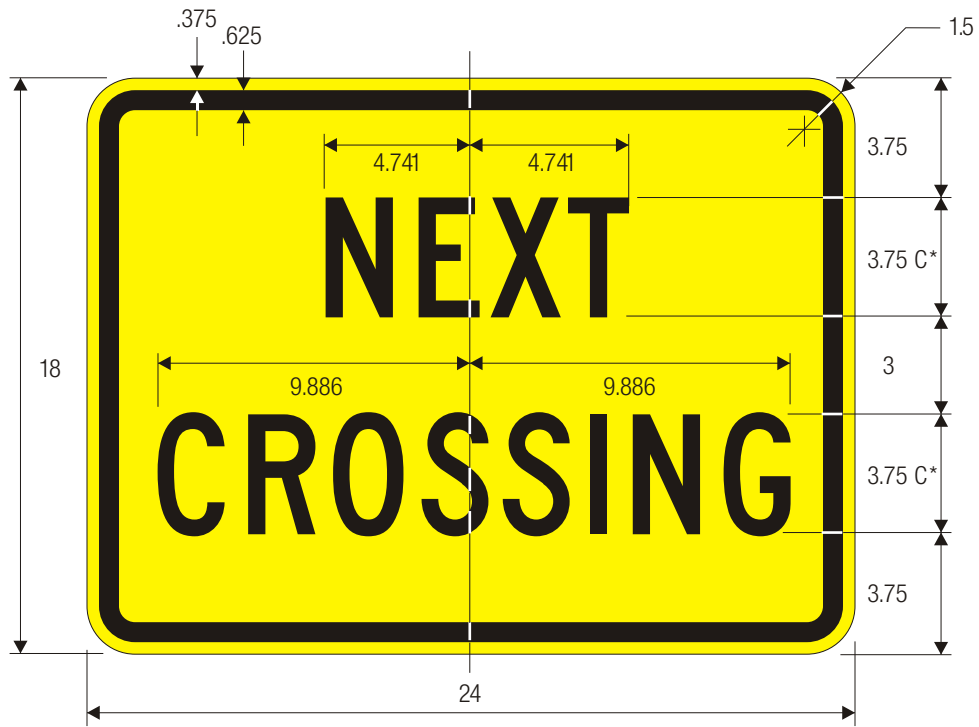

W10-14

NEXT CROSSING

For use with W10-5

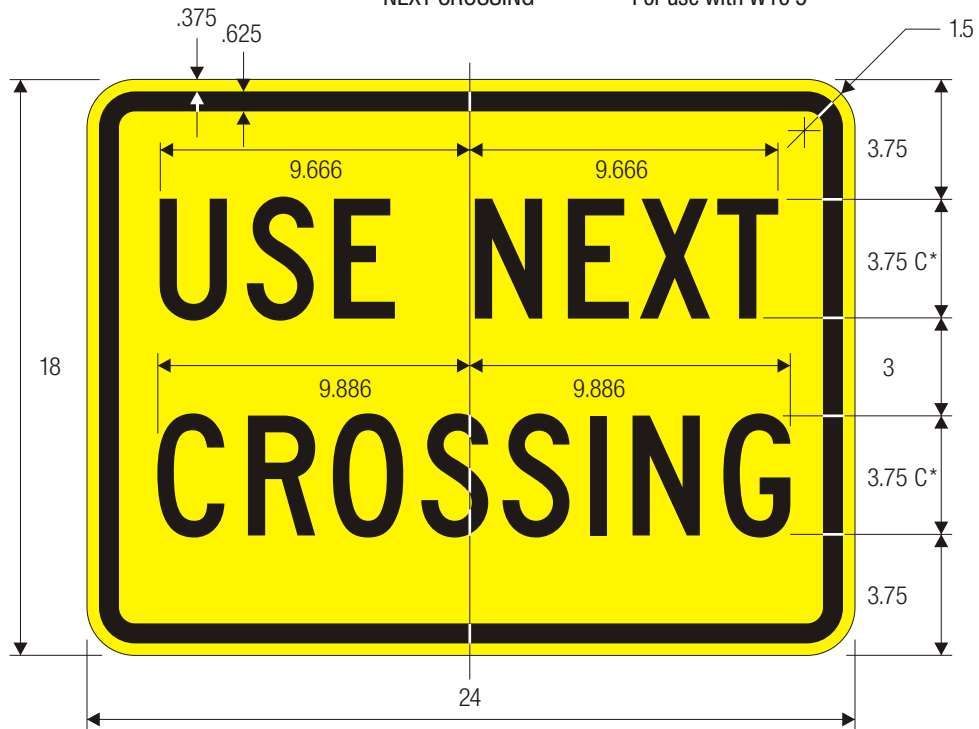

W10-14a

USE NEXT CROSSING

*Series 2000 Standard Alphabets.

COLORS: LEGEND — BLACK
 BACKGROUND — YELLOW (RETROREFLECTIVE)

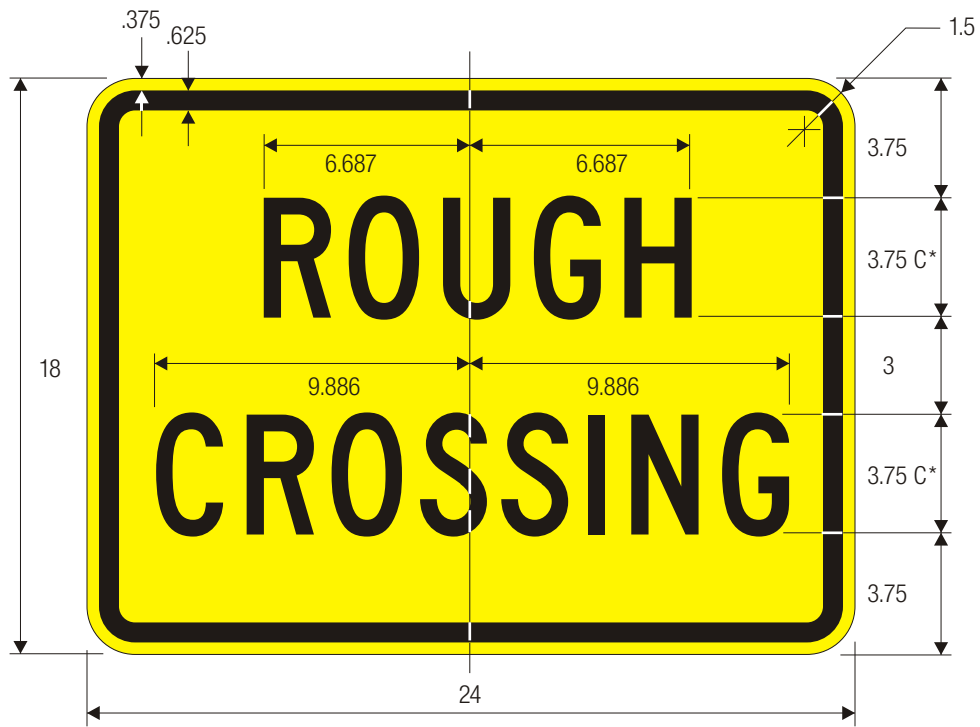

W10-15

*Series 2000 Standard Alphabets.

ROUGH CROSSING

COLORS: LEGEND — BLACK
BACKGROUND — YELLOW (RETROREFLECTIVE)



W11-1
BICYCLE TRAFFIC

*See page 6-7 for symbol design.

	A	B	C	D	E	F
	18	.375	.625	5	.594	1.5
C	24	.375	.625	6.688	.813	1.5
	30	.5	.75	8.5	1	1.875
	36	.625	.875	10	1.188	2.25
	48	.75	1.25	13.375	1.625	3

COLORS: SYMBOL — BLACK
BACKGROUND — YELLOW (RETROREFLECTIVE)

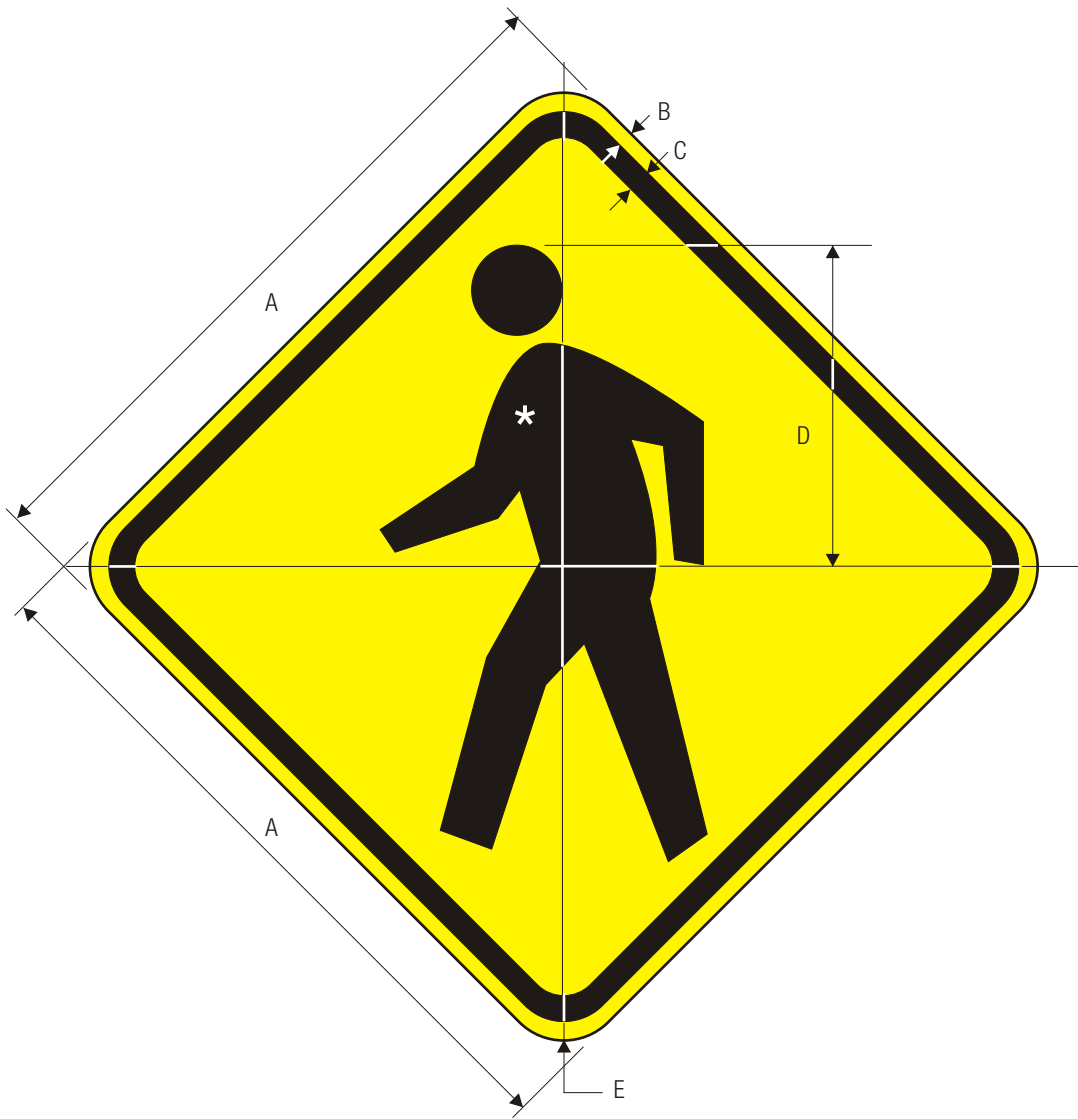

W11-2
PEDESTRIAN TRAFFIC

*See page 6-10 for symbol design.

	A	B	C	D	E
	18	.375	.625	8	1.5
	24	.375	.625	11	1.5
C	30	.5	.75	13.5	1.875
	36	.625	.875	16	2.25
	48	.75	1.25	22	3

COLORS: SYMBOL — BLACK
BACKGROUND — YELLOW (RETROREFLECTIVE)

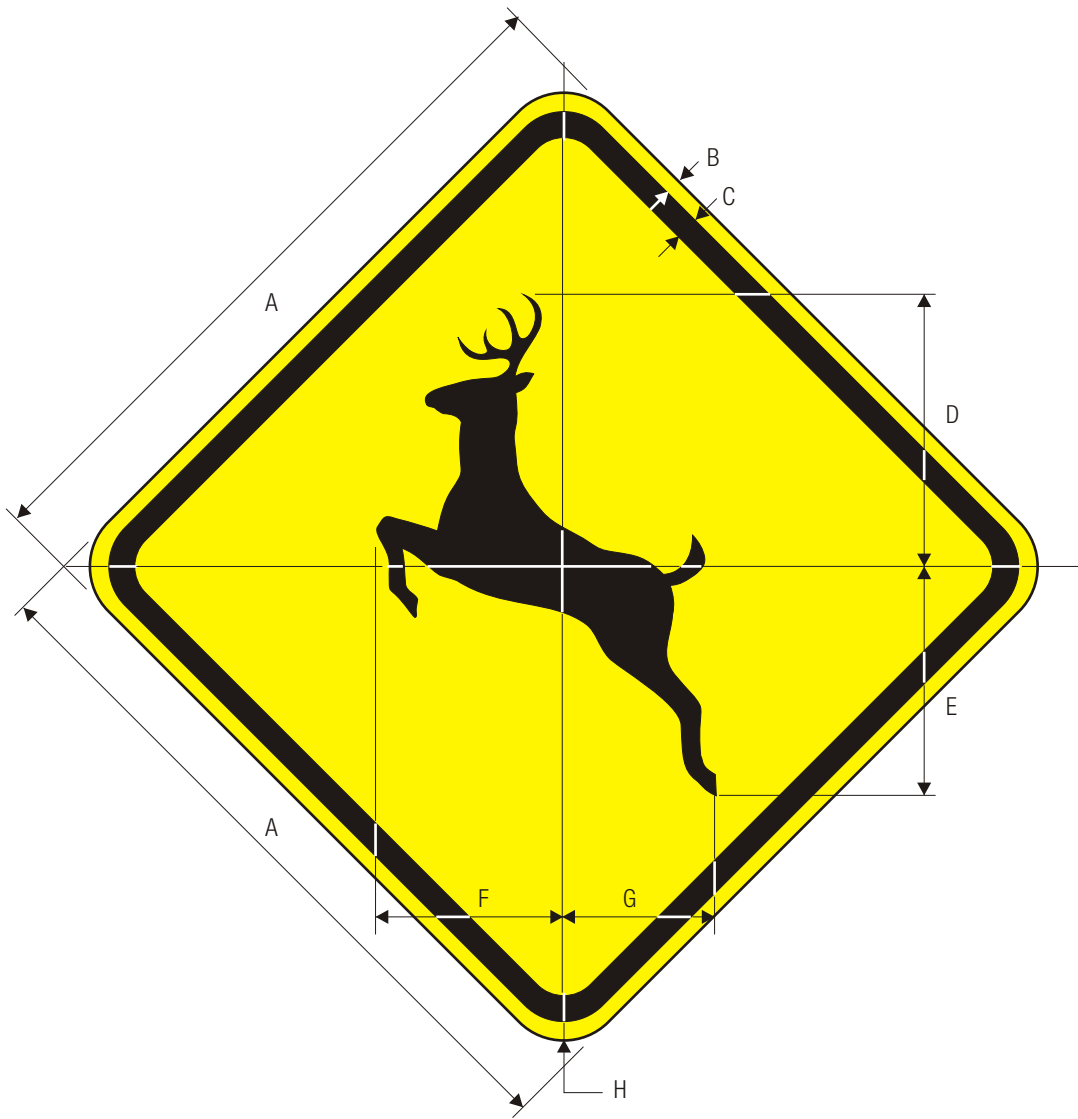

W11-3
DEER TRAFFIC

*See page 6-25 for symbol design.

	A	B	C	D	E	F	G	H
C	24	.375	.625	10.625	7.875	6.5	5.875	1.5
	30	.5	.75	13.5	10	8.25	7.5	1.875
	36	.625	.875	16.25	12	9.875	9	2.25
	48	.75	1.25	21.25	15.75	13	11.75	3

COLORS: SYMBOL — BLACK
BACKGROUND — YELLOW (RETROREFLECTIVE)

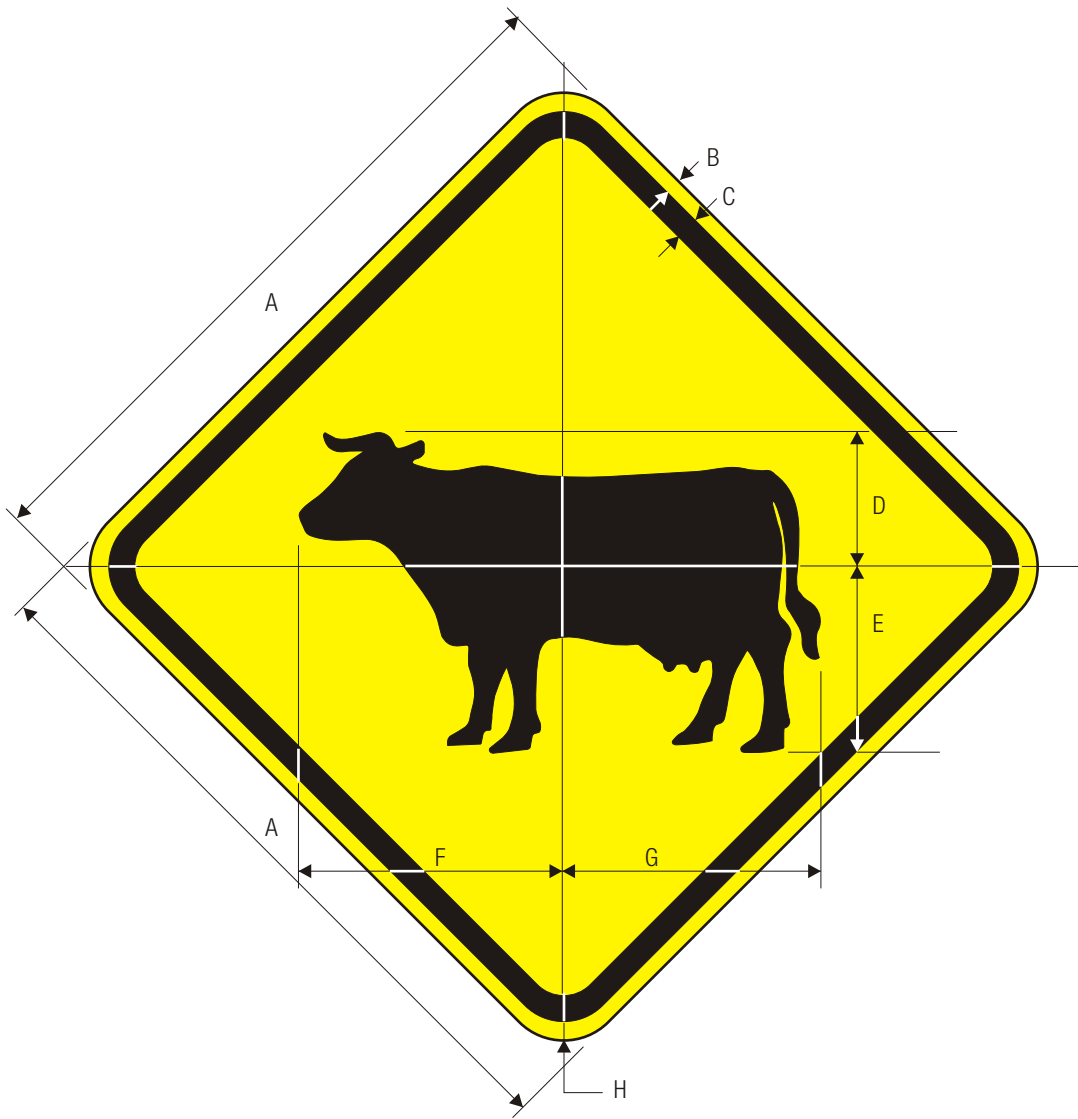

W11-4
CATTLE TRAFFIC

*See page 6-26 for symbol design.

	A	B	C	D	E	F	G	H
	24	.375	.625	4.75	6.313	9.25	8.313	1.5
C	30	.5	.75	6	8	11.75	10.5	1.875
	36	.625	.875	7.25	9.625	14.125	12.625	2.25
	48	.75	1.25	9.5	12.625	18.5	16.625	3

COLORS: SYMBOL — BLACK
BACKGROUND — YELLOW (RETROREFLECTIVE)

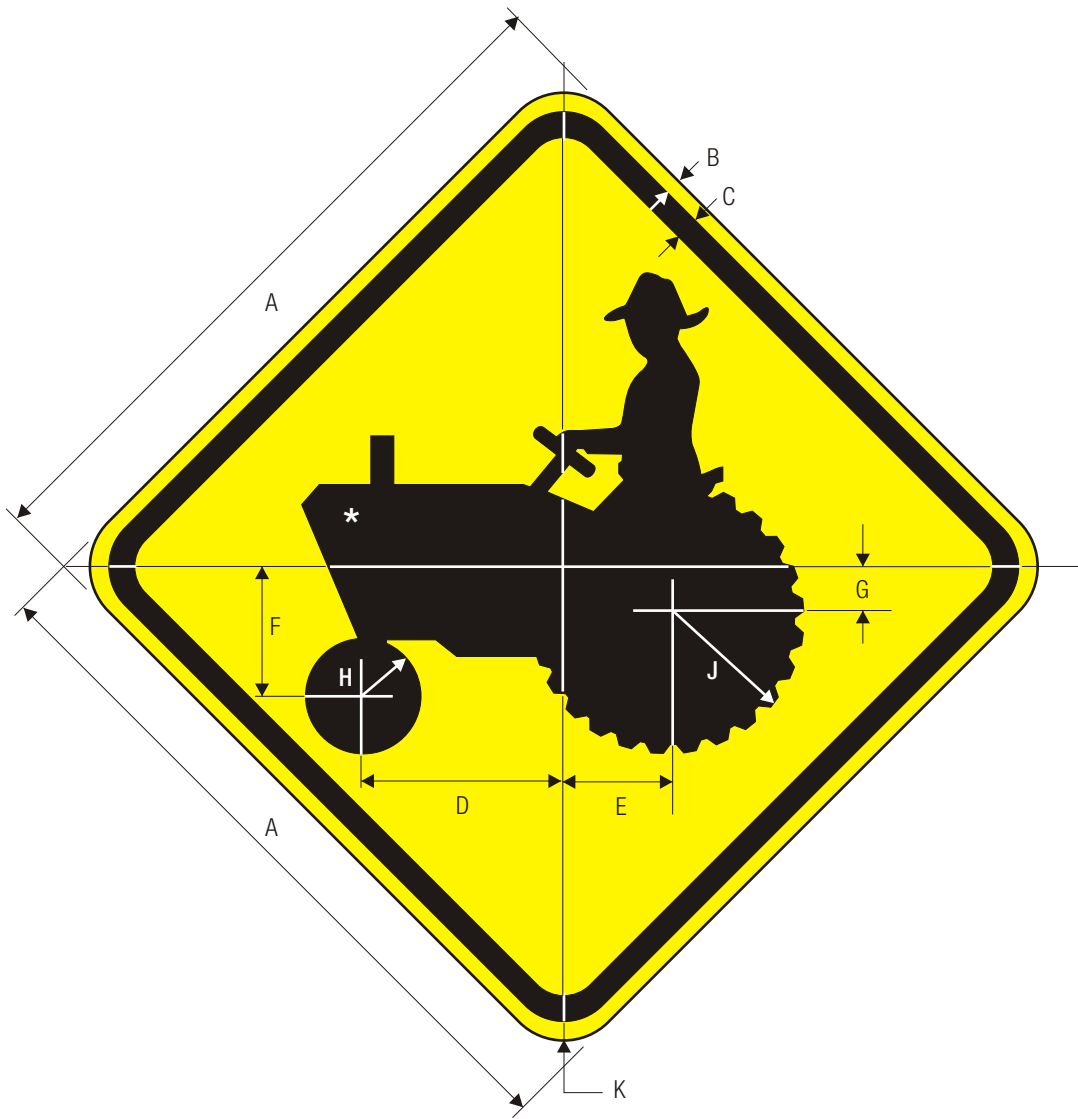

W11-5

FARM MACHINERY TRAFFIC

*See page 6-27 for symbol design.

	A	B	C	D	E	F	G	H	J	K
	24	.375	.625	6.875	3.75	4.375	1.375	2	4.75	1.5
C	30	.5	.75	8.75	4.75	5.5	1.75	2.5	6	1.875
	36	.625	.875	10.5	5.75	6.625	2.125	3	7.25	2.25
	48	.75	1.25	13.75	7.5	8.75	2.75	4	9.5	3

COLORS: SYMBOL — BLACK
 BACKGROUND — YELLOW (RETROREFLECTIVE)

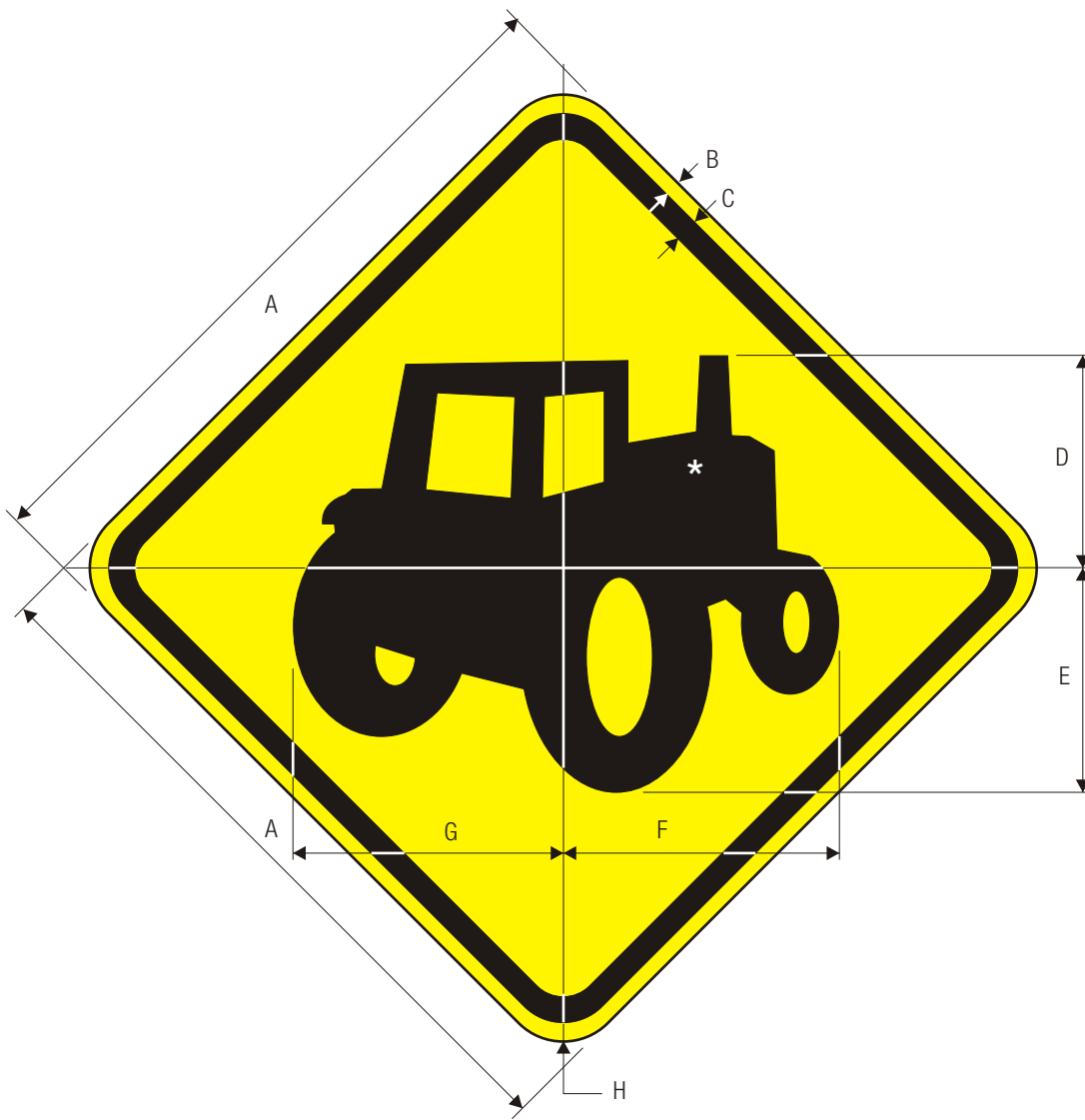

W11-5a

FARM MACHINERY TRAFFIC

*See page 6-28 for symbol design.

	A	B	C	D	E	F	G	H
	24	.375	.625	7.365	7.645	9.447	9.287	1.5
C	30	.5	.75	9.206	9.567	11.808	11.608	1.875
	36	.625	.875	11.048	11.488	14.170	13.930	2.25
	48	.75	1.25	14.731	15.331	18.894	18.574	3

COLORS: SYMBOL — BLACK
 BACKGROUND — YELLOW (RETROREFLECTIVE)

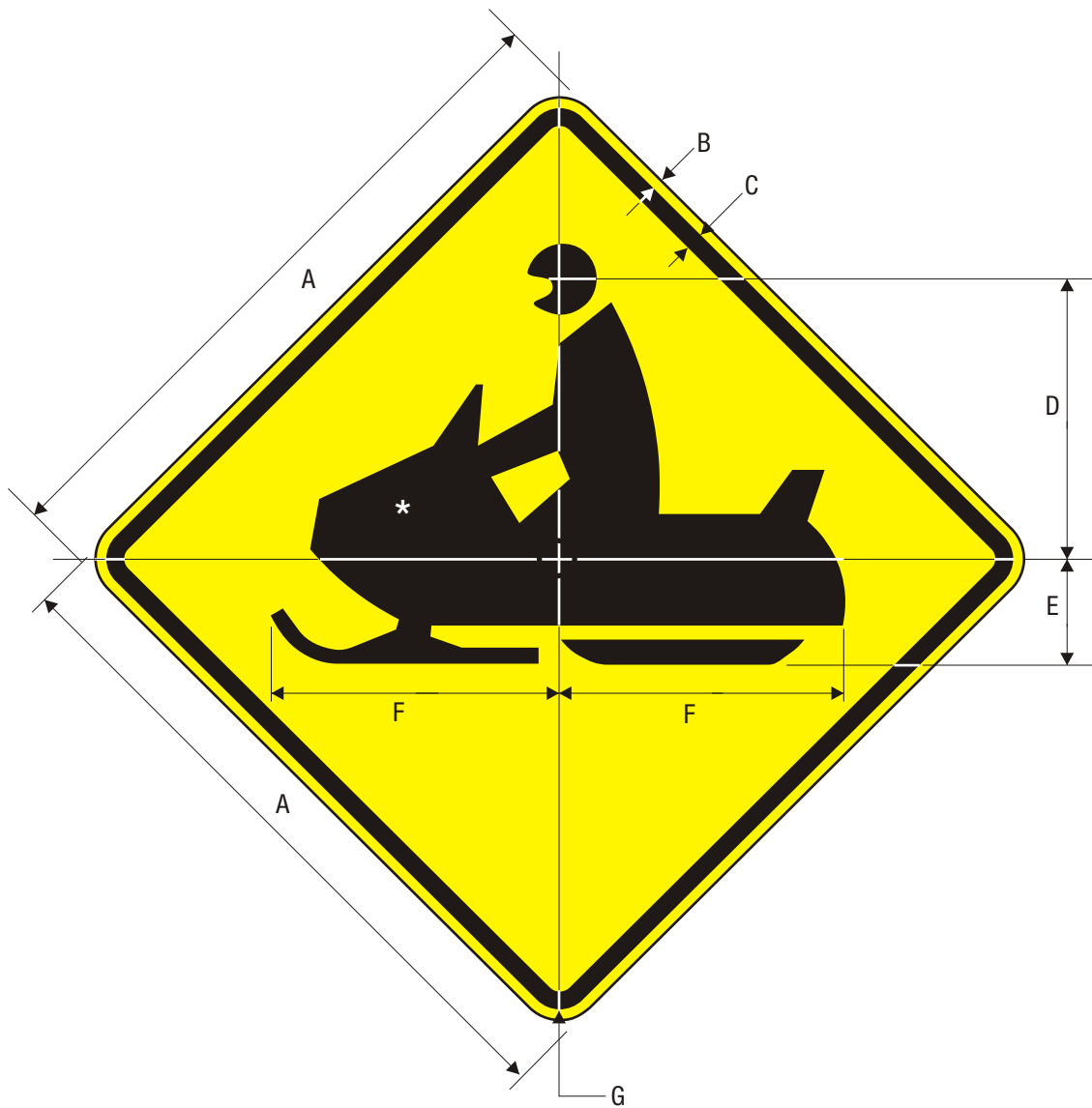

W11-6

SNOWMOBILE TRAFFIC

*See page 6-29 for symbol design.

	A	B	C	D	E	F	G
	24	.375	.625	7.375	4.688	8.875	1.5
C	30	.5	.75	9.188	5.875	10.063	1.875
	36	.625	.875	11.063	7.063	13.25	2.25

COLORS: SYMBOL — BLACK
 BACKGROUND — YELLOW (RETROREFLECTIVE)

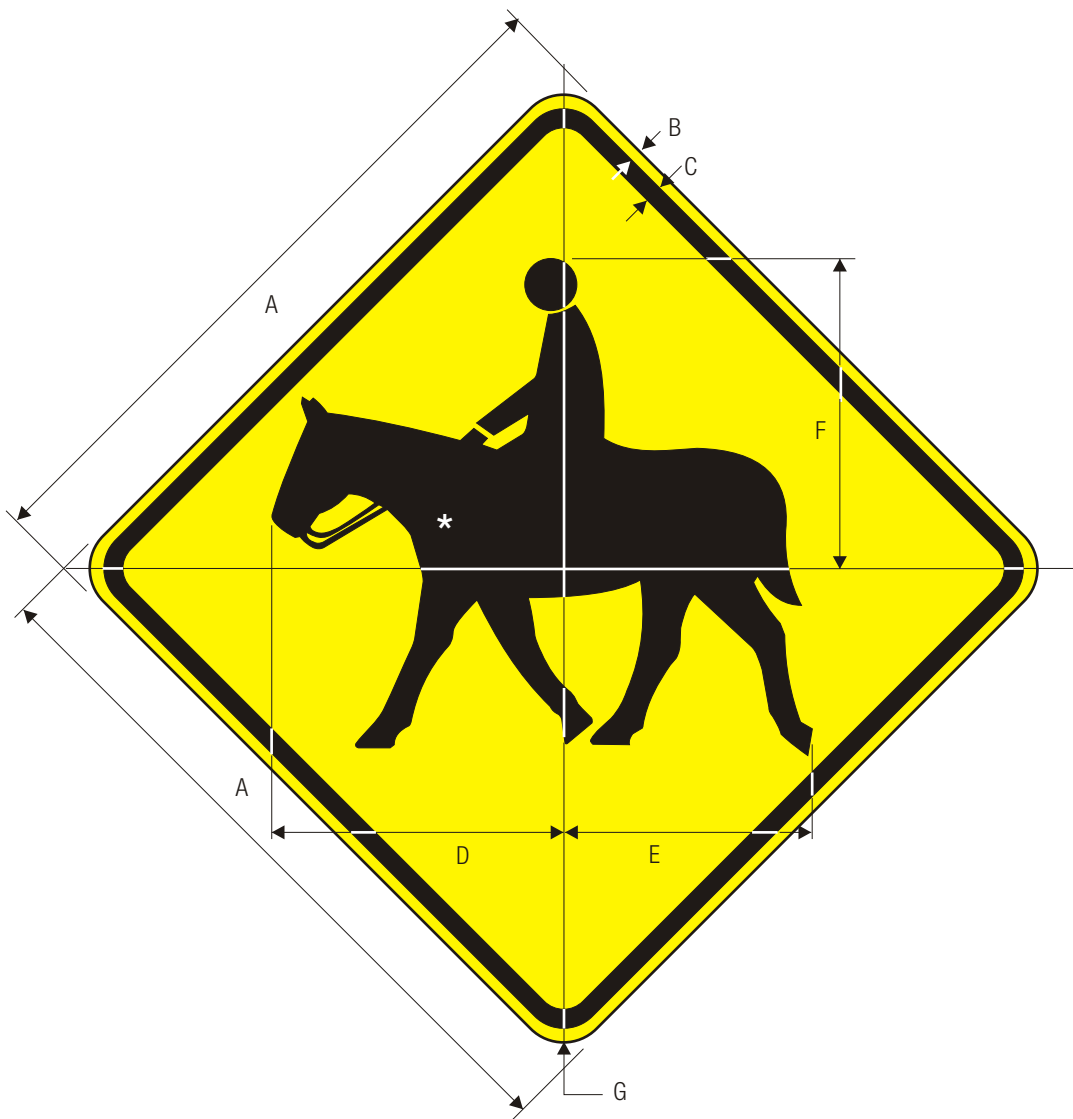

W11-7

EQUESTRIAN TRAFFIC

*See page 6-30 for symbol design.

	A	B	C	D	E	F	G
	24	.375	.625	10.5	8	10.625	1.5
C	30	.5	.75	13	10	13	1.875
	36	.625	.875	15.5	12	15.625	2.25
	48	.75	1.25	21	16	21	3

COLORS: SYMBOL — BLACK
BACKGROUND — YELLOW (RETROREFLECTIVE)

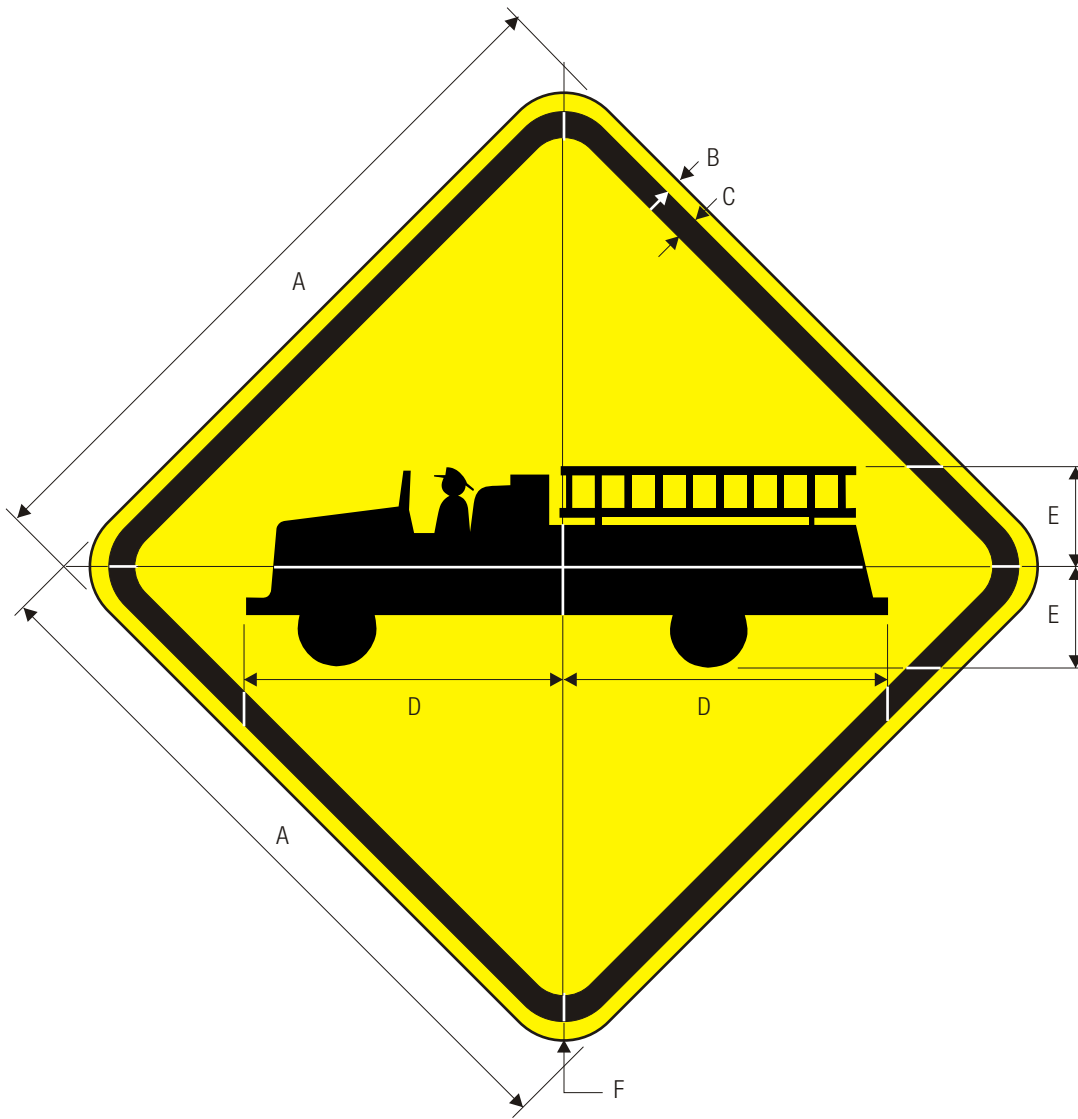

W11-8

EMERGENCY VEHICLE

*See page 6-16 for symbol design.

	A	B	C	D	E	F
	24	.375	.625	11	3.5	1.5
C	30	.5	.75	13.75	4.375	1.875
	36	.625	.875	16.5	5.25	2.25
	48	.75	1.25	22	7	3

COLORS: SYMBOL — BLACK
BACKGROUND — YELLOW (RETROREFLECTIVE)

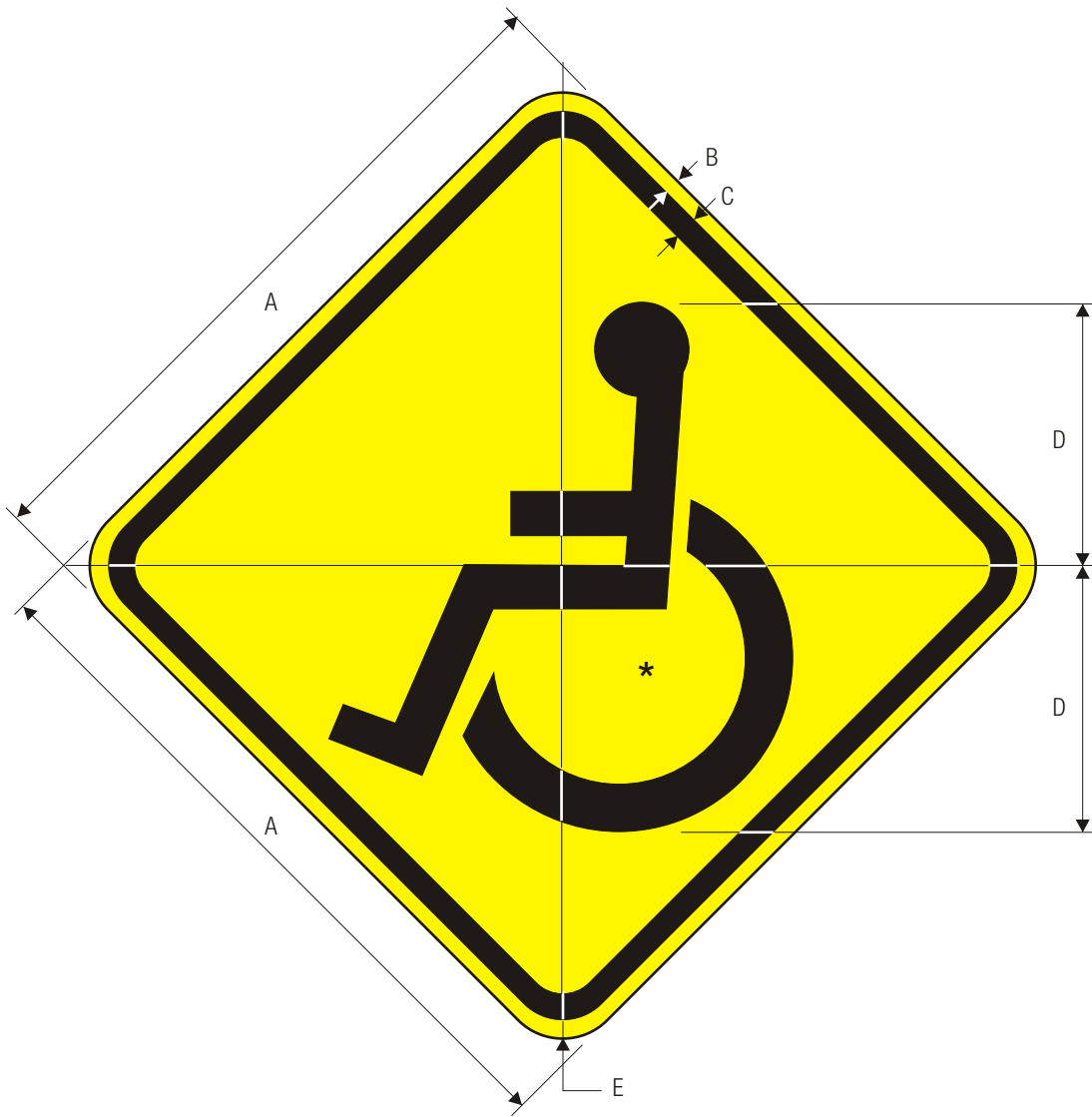

W11-9
HANDICAPPED

*See page 6-31 for symbol design.

	A	B	C	D	E
	24	.375	.625	9	1.5
C	30	.5	.75	11.25	1.875
	36	.625	.875	13.5	2.25
	48	.75	1.25	18	3

COLORS: SYMBOL — BLACK
BACKGROUND — YELLOW (RETROREFLECTIVE)

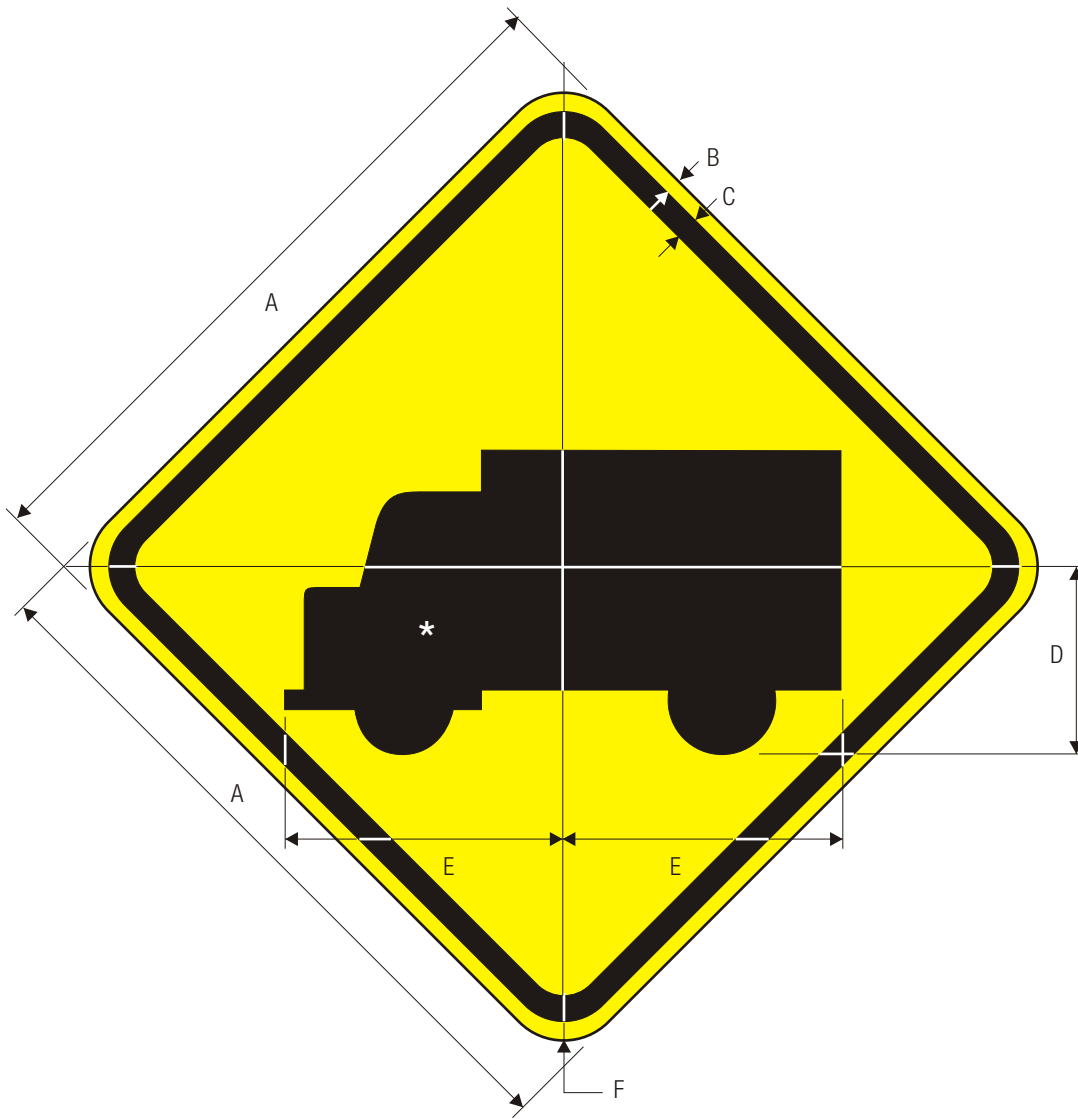

W11-10

TRUCK CROSSING

*See page 6-4 for symbol design.

	A	B	C	D	E	F
	24	.375	.625	7	9.5	1.5
C	30	.5	.75	9	12	1.875
	36	.625	.875	10	14	2.25
	48	.75	1.25	14	19	3

WARNING SIGN COLORS:
 SYMBOL — BLACK
 BACKGROUND— YELLOW (RETROREFLECTIVE)

TTC SIGN COLORS:
 SYMBOL — BLACK
 BACKGROUND— ORANGE (RETROREFLECTIVE)

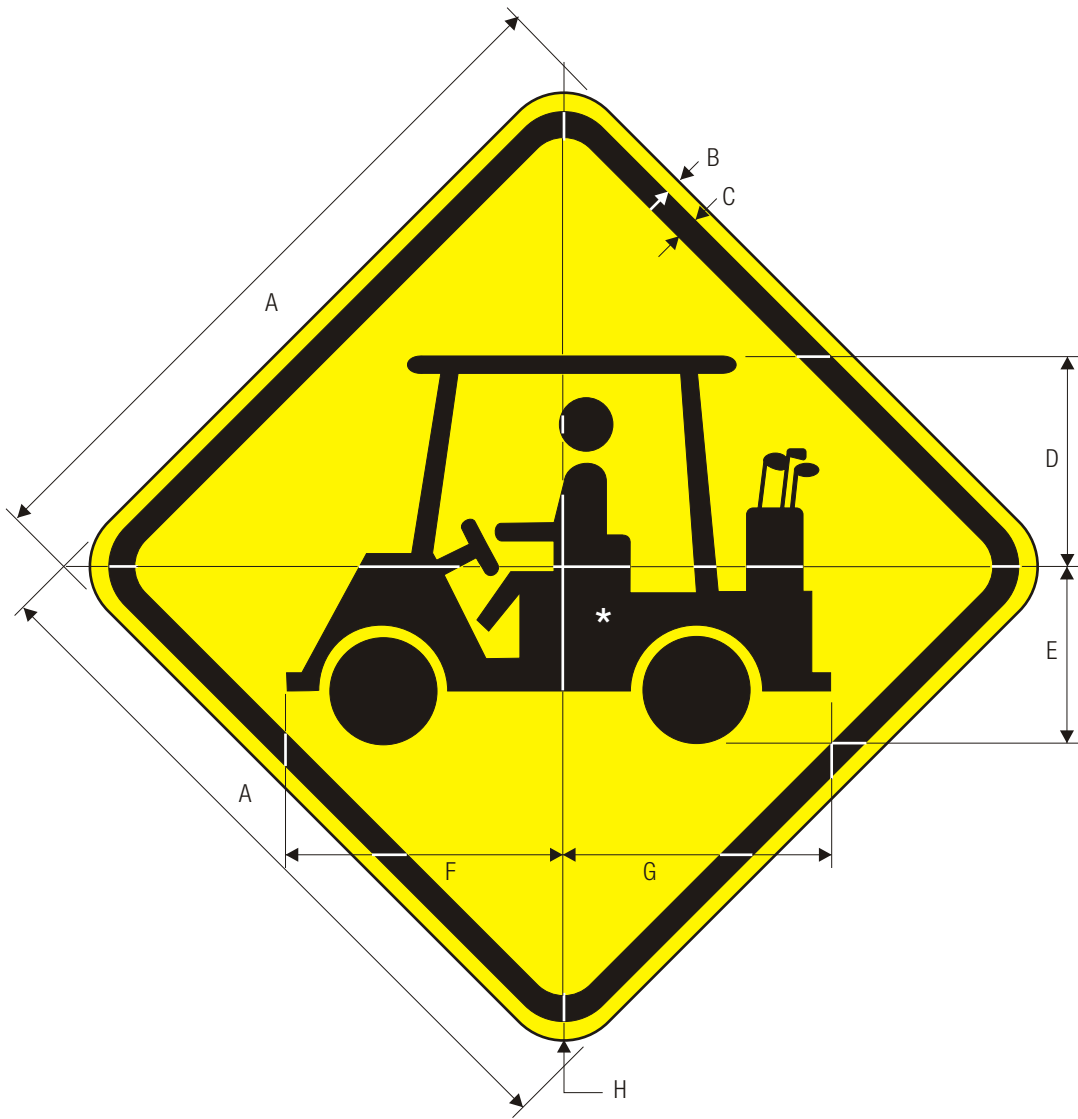

W11-11

GOLF CART TRAFFIC

*See page 6-32 for symbol design.

	A	B	C	D	E	F	G	H
	24	.375	.625	7.285	6.064	9.467	9.126	1.5
C	30	.5	.75	9.126	7.605	11.889	11.448	1.875
	36	.625	.875	10.928	9.126	14.250	13.730	2.25
	48	.75	1.25	14.571	12.129	18.934	18.253	3

COLORS: SYMBOL — BLACK
 BACKGROUND — YELLOW (RETROREFLECTIVE)



W11-12p

EMERGENCY SIGNAL AHEAD

For use with W11-8 Emergency Vehicle Design.

*Series 2000 Standard Alphabets.

C

A	B	C	D	E	F	G	H	J	K	L	M
24	18	.375	.625	3	3 C	1.5	3	9.667	5.704	5.223	1.5
30	24	.5	.75	4	4 C	2	4	12.889	7.605	6.985	1.875
36	30	.625	.875	5.625	4.25 C	3	5.625	14.190	8.366	7.665	2.25

COLORS: LEGEND — BLACK
 BACKGROUND — YELLOW (RETROREFLECTIVE)

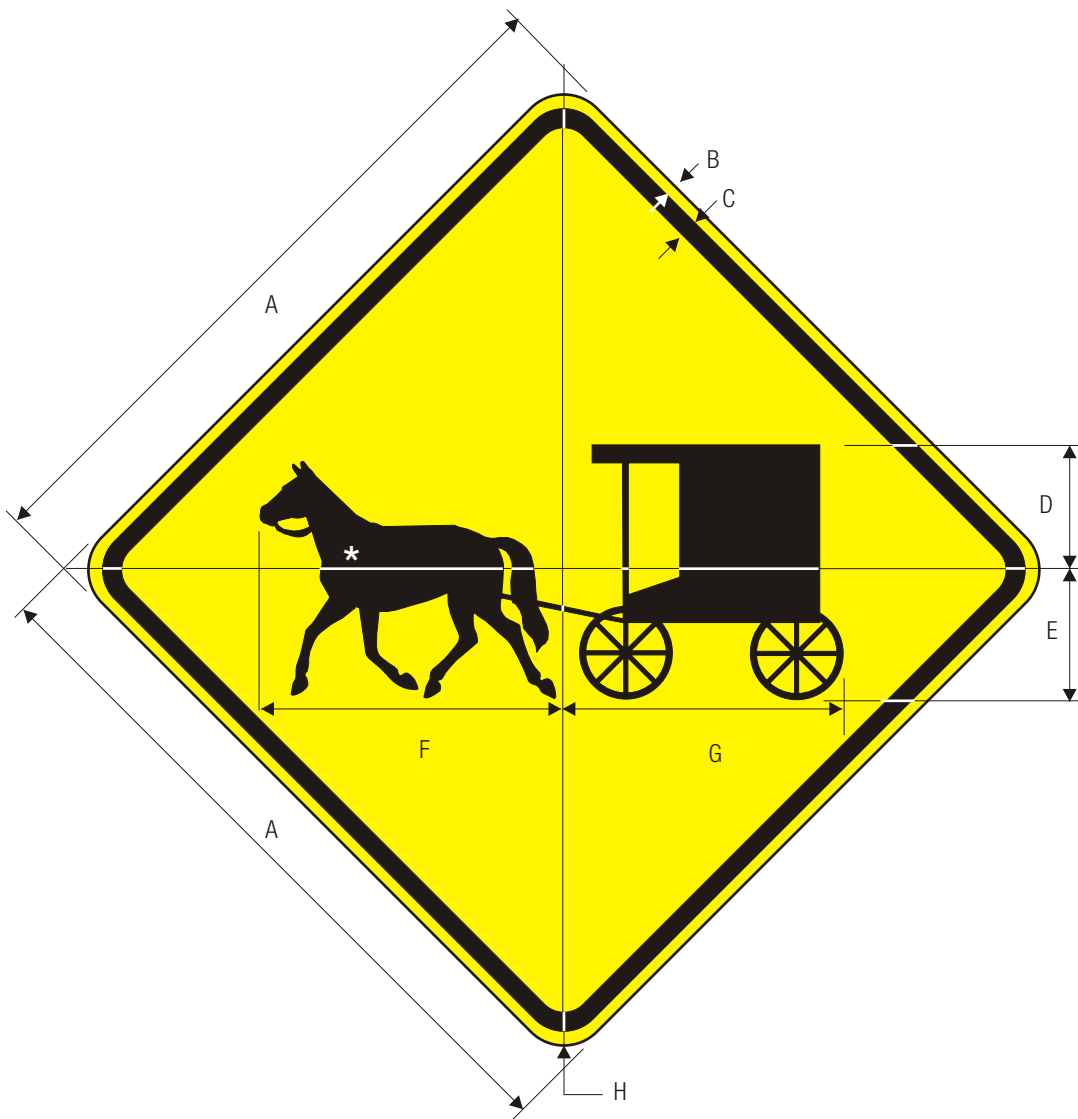

W11-14

HORSE AND BUGGY TRAFFIC

*See page 6-37 for symbol design.

	A	B	C	D	E	F	G	H
	24	.375	.625	4.323	4.443	10.407	9.567	1.5
C	30	.5	.75	5.404	5.564	13.000	11.969	1.875
	36	.625	.875	6.484	6.685	15.611	14.370	2.25
	48	.75	1.25	8.646	8.926	20.815	19.174	3

COLORS: LEGEND — BLACK
 BACKGROUND — YELLOW (RETROREFLECTIVE)

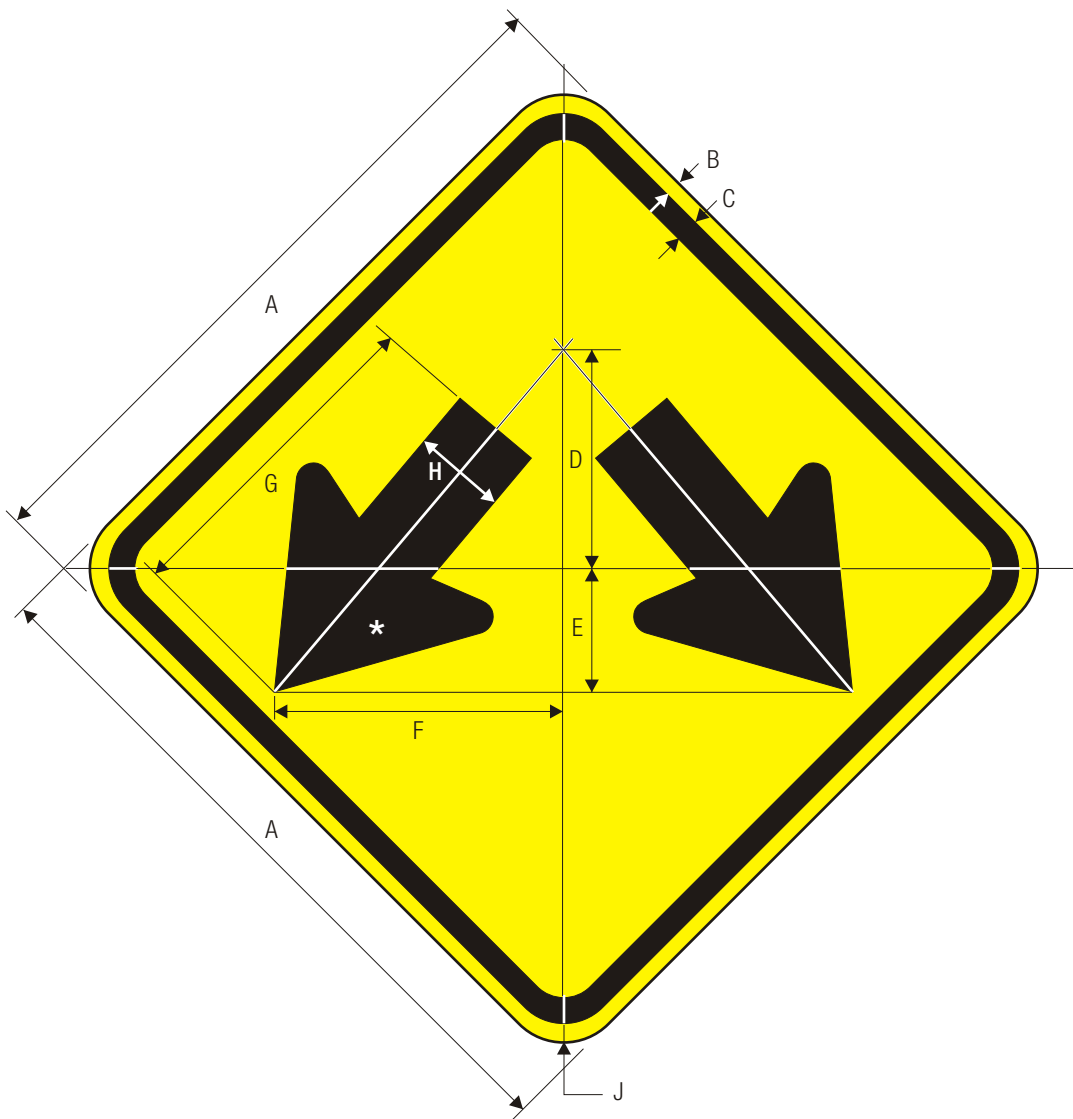

W12-1
DOUBLE ARROW

*See page 6-2 for symbol design.

	A	B	C	D	E	F	G	H	J
	24	.375	.625	8	4.125	9.75	11.625	3.125	1.5
C	30	.5	.75	10	5.25	12.375	14.688	4	1.875
	36	.625	.875	12	6.125	14.625	17.5	4.75	2.25
	48	.75	1.25	16	8.25	19.5	23.25	6.25	3

WARNING SIGN COLORS:

SYMBOL — BLACK
BACKGROUND — YELLOW (RETROREFLECTIVE)

TTC SIGN COLORS:

SYMBOL — BLACK
BACKGROUND — ORANGE (RETROREFLECTIVE)



W12-2
LOW CLEARANCE (ENGLISH)

LOW CLEARANCE (METRIC)

A	B	C	D	E	F	G	H	J	K	L	M	N
18	.375	.625	3.438	4	2.125	.5	1.5	1	1.5	.938	.625	.25
30	.5	.75	5.75	6.625	3.75	.75	2.5	1.688	1.875	1.563	1	.438
36	.625	.875	6.875	8	4.25	1	3	2	2.25	1.875	1.25	.5
48	.75	1.25	9.188	10.625	5.875	1.313	4	2.625	3	2.438	1.625	.625

C

P	Q	R	S
1.375	2	3	6 D
2.25	3.313	5	10 D
2.75	4	6	12 D
3.625	5.58	8	16 D

*See page 6-3 for symbol design.
**Optically space numerals about center line.

WARNING SIGN COLORS:

SYMBOL & LEGEND—BLACK
BACKGROUND —YELLOW (RETROREFLECTIVE)

TTC SIGN COLORS:

SYMBOL & LEGEND—BLACK
BACKGROUND —ORANGE (RETROREFLECTIVE)

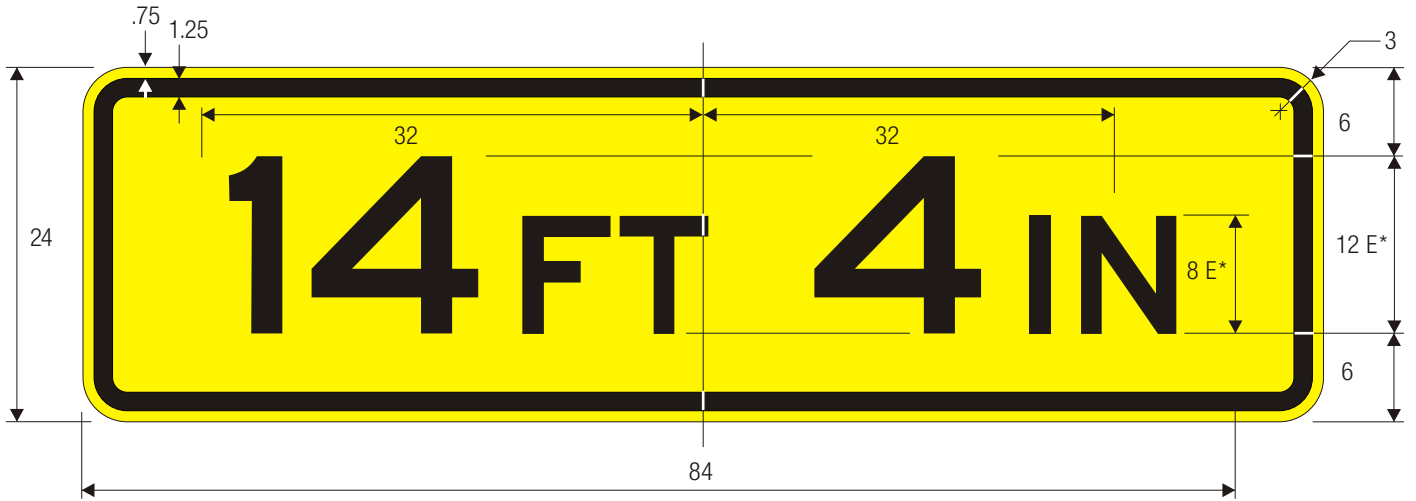

W12-2p

LOW CLEARANCE (ENGLISH)

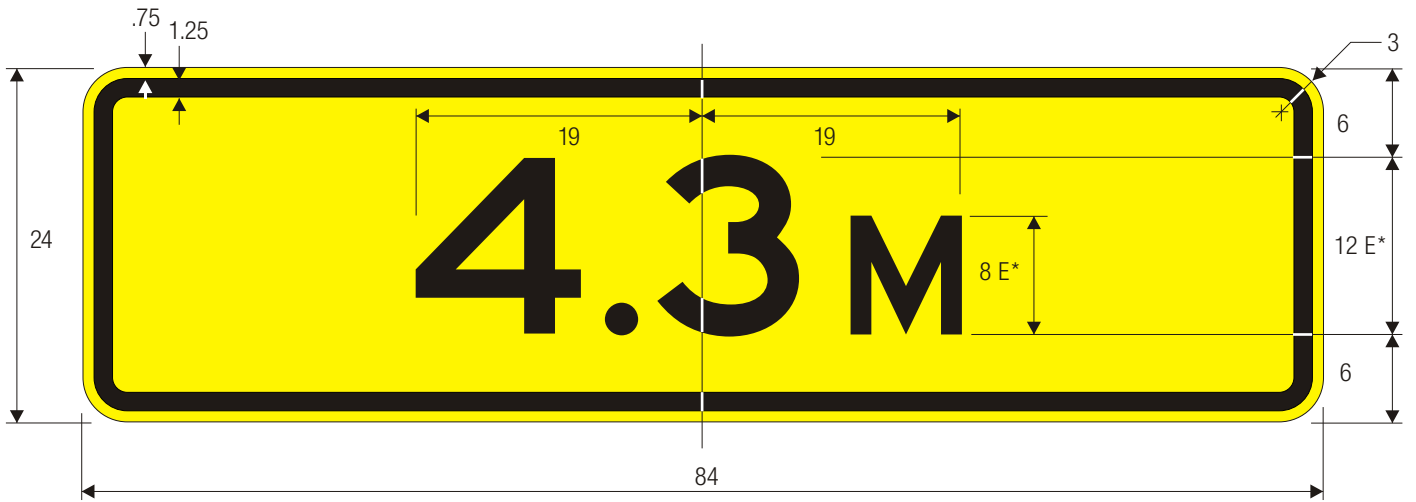

W12-2p metric

LOW CLEARANCE (METRIC)

*Series 2000 Standard Alphabets.

COLORS: LEGEND — BLACK
 BACKGROUND — YELLOW (RETROREFLECTIVE)



W13-1

ADVISORY SPEED (ENGLISH)

*Series 2000 Standard Alphabets.

**Optically space numerals about vertical centerline.

	A	B	C	D	E	F	G	H	J
C	18	.375	.625	2.5	8 E	2	3 E	4.723	1.5
	24	.375	.625	3.625	10 E	2.75	4 E	6.284	1.5
	30	.5	.75	4.5	12 E	4	5 E	7.416	1.875

WARNING SIGN COLORS:

LEGEND — BLACK
BACKGROUND — YELLOW (RETROREFLECTIVE)

TTC SIGN COLORS:

LEGEND — BLACK
BACKGROUND — ORANGE (RETROREFLECTIVE)



W13-1

ADVISORY SPEED (METRIC)

	A	B	C	D	E	F	G	H	J
C	18	.375	.625	5.5	4 D	4	2.5 E	2	3.986
	24	.375	.625	7.375	5 D	5.75	3.25 E	2.625	5.581
	30	.5	.75	9	6 D	7	4	4	6.478

	K	L	M	N	P
	10.625	2	4.688	5.312	1.5
	14.25	2.625	6.5	7.125	1.5
	17.813	3.313	8.156	8.906	1.875

*Optically space numerals about vertical centerline.

WARNING SIGN COLORS:

LEGEND — BLACK
BACKGROUND — YELLOW (RETROREFLECTIVE)

TTC SIGN COLORS:

LEGEND — BLACK
BACKGROUND — ORANGE (RETROREFLECTIVE)



W13-2

ADVISORY SPEED (ENGLISH)

*Optically space numerals about centerline.
 **Increase spacing to 100%.

C

A	B	C	D	E	F	G	H	J	K	L	M
24	30	.375	.625	3.5	4 E	2.5	2.875	8 E	3 E	3	6.125
36	48	.625	.875	6	6 E	4	5.125	12 E	4 E	6	9.25
48	60	.75	1.25	7	8 E	5	5.75	16 E	6 E	6	12.25

N	P	Q
6.375	5.313	1.5
9.5	7.063	2.25
12.75	10.625	3

COLORS: LEGEND — BLACK
 BACKGROUND— YELLOW (RETROREFLECTIVE)

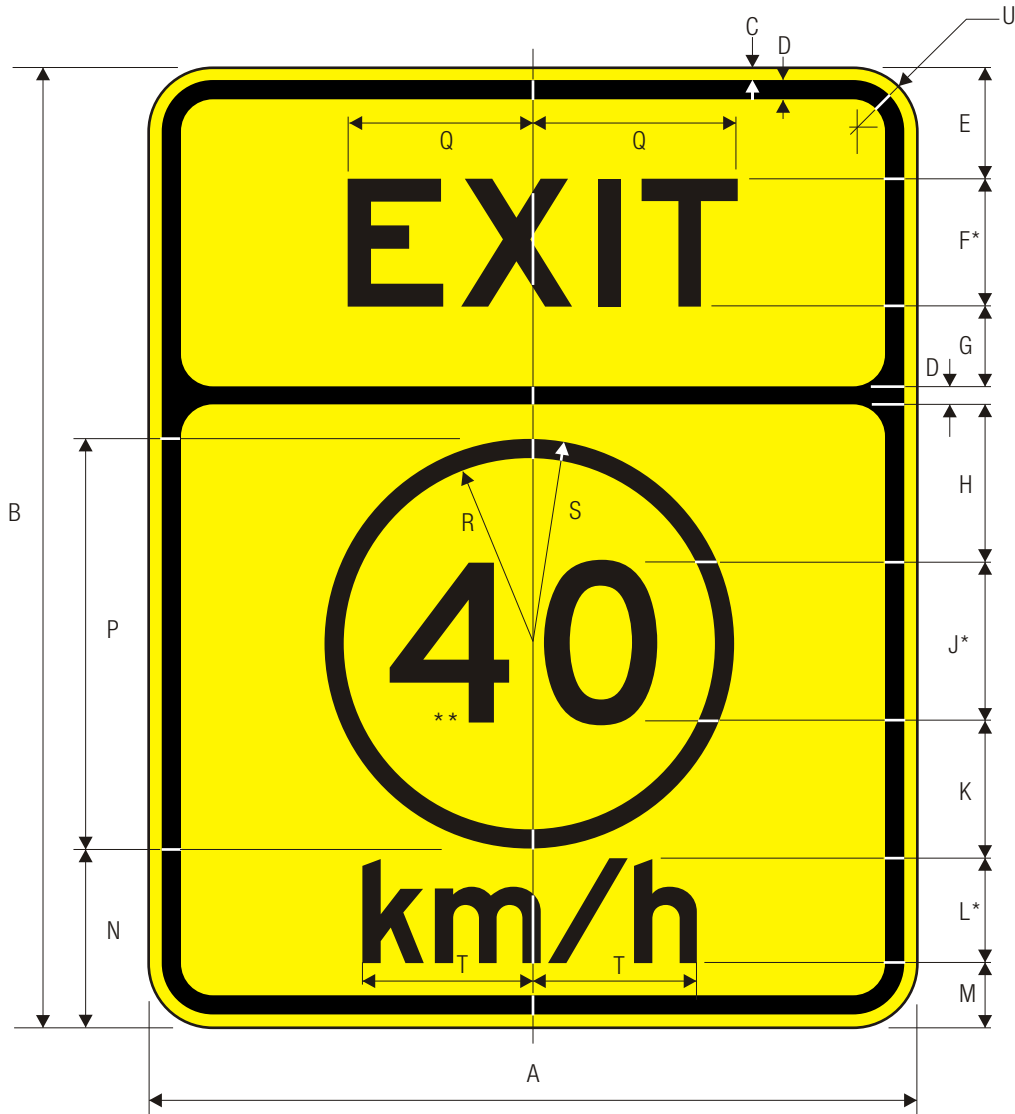

W13-2

ADVISORY EXIT SPEED (METRIC)

*Series 2000 Standard Alphabets.

**Optically space numerals about centerline.

C

A	B	C	D	E	F	G	H	J	K	L	M
24	30	.375	.625	3.5	4 E	2.5	4.875	5 D	4.5	3 E	2
36	48	.625	.875	6	6 E	4	7.25	8 D	7	5 E	3.875
48	60	.75	1.25	7	8 E	5	9.313	10 D	8.688	6 E	4.75

N	P	Q	R	S	T	U
5.5	13	6.094	5.875	6.5	4.841	1.5
9.75	20.5	9.140	9.375	10.25	8.020	2.25
11.5	25.625	12.189	11.563	12.813	9.650	3

COLORS: LEGEND — BLACK
 BACKGROUND — YELLOW (RETROREFLECTIVE)
 CIRCLE — BLACK



W13-3

ADVISORY RAMP SPEED

*Optically space numerals about centerline.
 **Increase spacing 100%.

C

A	B	C	D	E	F	G	H	J	K	L	M
24	30	.375	.625	3.5	4 E	2.5	2.875	8 E	3 E	3	8.25
36	48	.625	.875	6	6 E	4	5.125	12 E	4 E	6	12.375
48	60	.75	1.25	7	8 E	5	5.75	16 E	6 E	6	16.5

N	P	Q
8.5	5.313	1.5
12.75	7.063	2.25
17	10.625	3

COLORS: LEGEND — BLACK
 BACKGROUND— YELLOW (RETROREFLECTIVE)

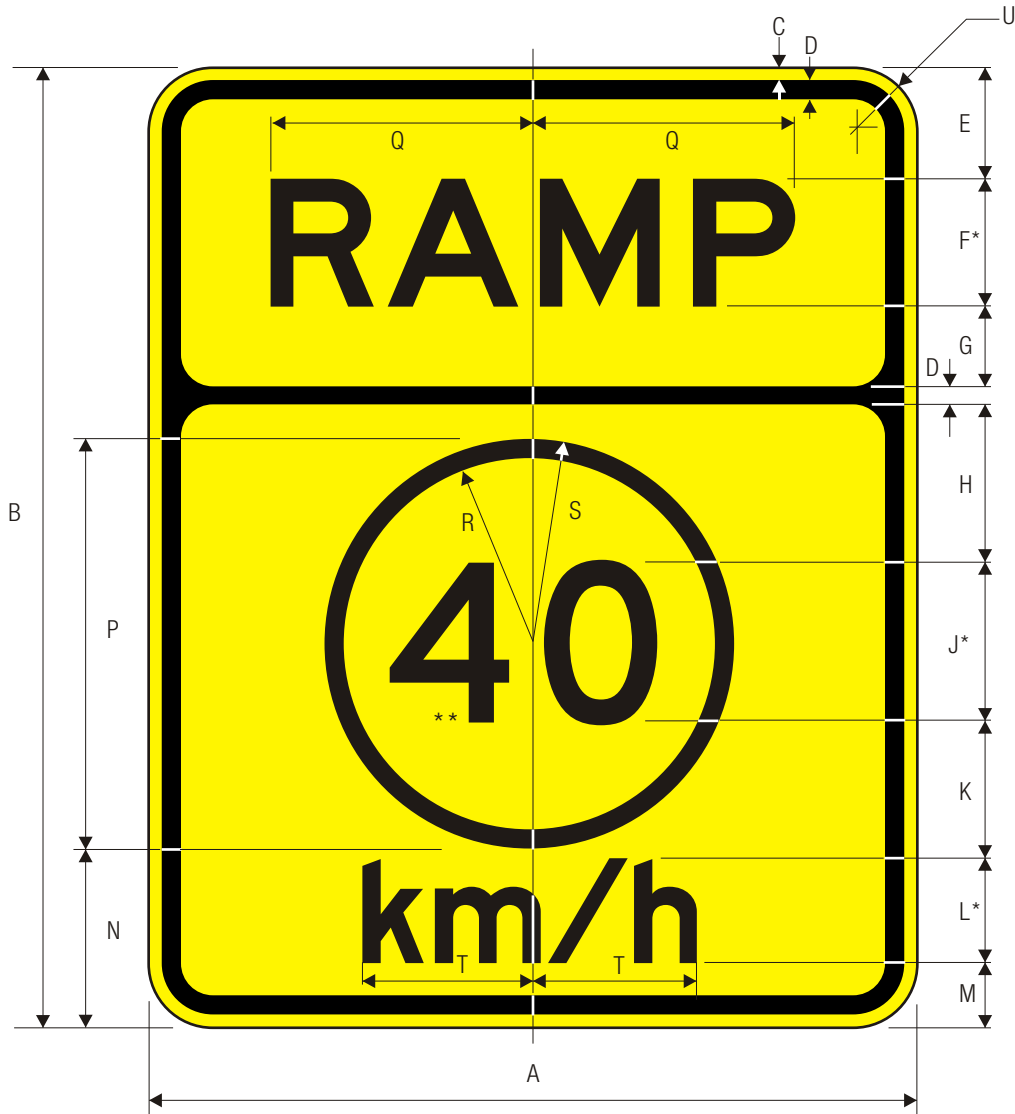

W13-3

ADVISORY RAMP SPEED

*Series 2000 Standard Alphabets.

**Optically space numerals about centerline.

C

A	B	C	D	E	F	G	H	J	K	L	M
24	30	.375	.625	3.5	4 E	2.5	4.875	5 D	4.5	3 E	2
36	48	.625	.875	6	6 E	4	7.25	8 D	7	5 E	3.875
48	60	.75	1.25	7	8 E	5	9.313	10 D	8.688	6 E	4.75

N	P	Q	R	S	T	U
5.5	13	8.198	5.875	6.5	4.841	1.5
9.75	20.5	12.296	9.375	10.25	8.020	2.25
11.5	25.625	16.396	11.563	12.813	9.650	3

COLORS: LEGEND — BLACK
 BACKGROUND — YELLOW (RETROREFLECTIVE)
 CIRCLE — BLACK



W13-5

ADVISORY CURVE SPEED (ENGLISH)

- *Series 2000 Standard Alphabets.
- **Optically space numerals about centerline.
- ***Increase spacing to fit.

	A	B	C	D	E	F	G	H	J	K	L	M
C	24	30	.375	.625	3.482	4 E	2.481	2.401	8 E	4 E	2.642	9.727
	36	48	.625	.875	6	6 E	4	4.803	12 E	5 E	4.403	14.611
	48	60	.75	1.25	7	8 E	5	5.203	16 E	6 E	7	19.474

N	P
5.243	1.5
8.966	2.25
11.048	3

COLORS: LEGEND — BLACK
BACKGROUND— YELLOW (RETROREFLECTIVE)

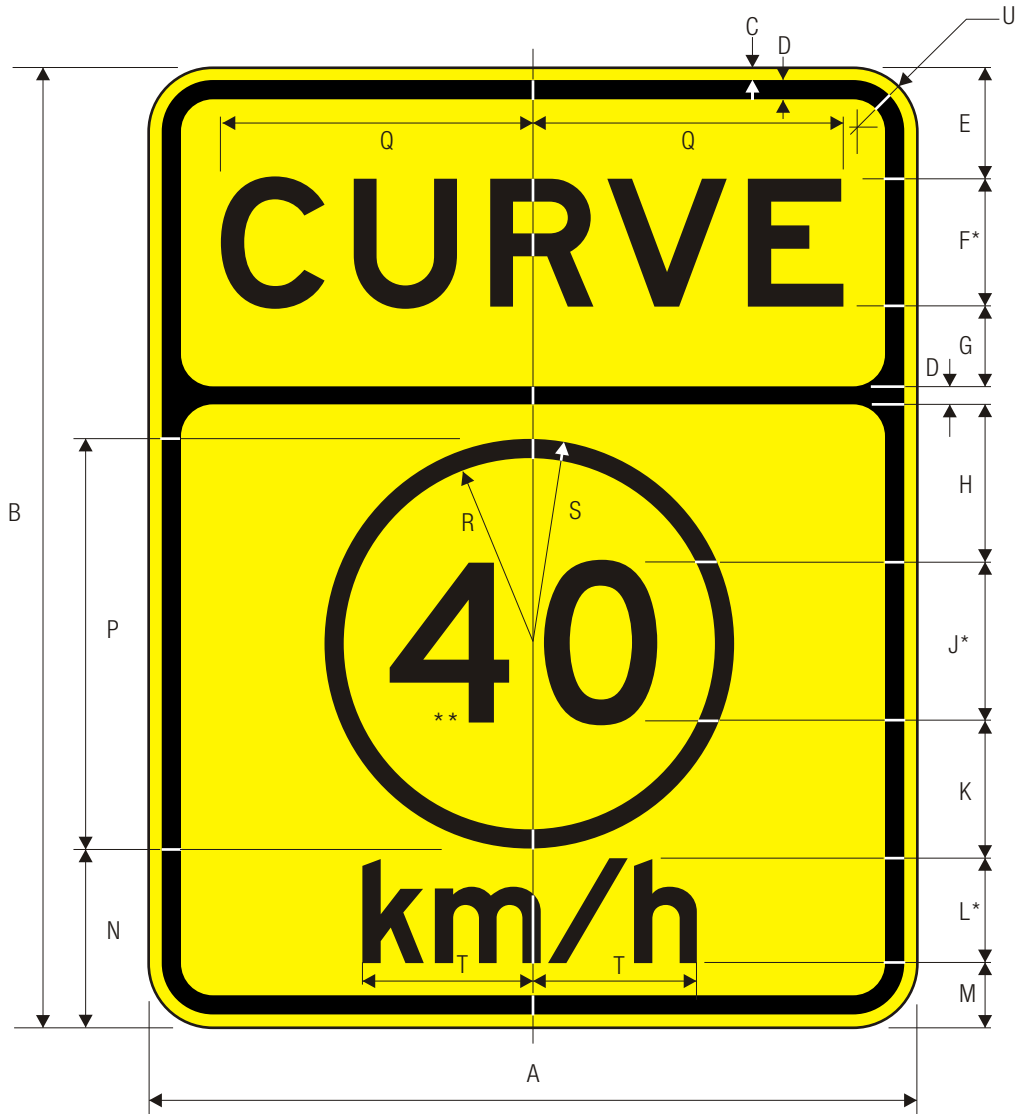

W13-5 Metric

ADVISORY CURVE SPEED (METRIC)

*Series 2000 Standard Alphabets.

**Optically space numerals about centerline.

C

A	B	C	D	E	F	G	H	J	K	L	M
24	30	.375	.625	3.5	4 E	2.5	4.875	5 D	4.5	3 E	2
36	48	.625	.875	6	6 E	4	7.25	8 D	7	5 E	3.875
48	60	.75	1.25	7	8 E	5	9.313	10 D	8.688	6 E	4.75

N	P	Q	R	S	T	U
5.5	13	9.727	5.875	6.5	4.841	1.5
9.75	20.5	14.589	9.375	10.25	8.020	2.25
11.5	25.625	19.454	11.563	12.813	9.650	3

COLORS: LEGEND — BLACK
 BACKGROUND — YELLOW (RETROREFLECTIVE)
 CIRCLE — BLACK

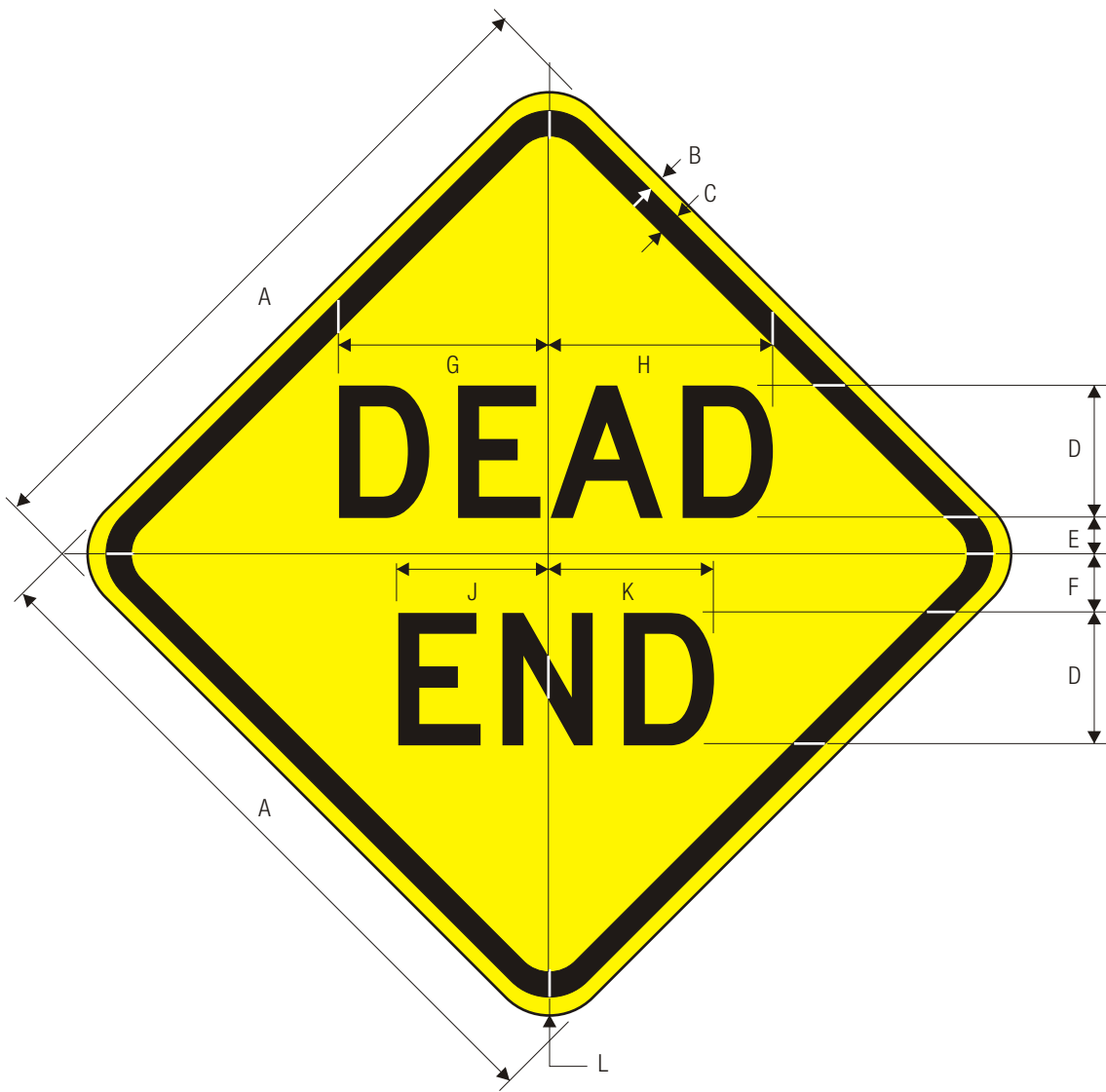

W14-1
DEAD END

	A	B	C	D	E	F	G	H	J	K	L
C	24	.375	.625	5 D	1	2	8.25	8.563	5.625	6.25	1.5
	30	.5	.75	6 D	1.5	2.5	9.75	10.25	6.75	7.5	1.875
	36	.625	.875	7 D	2	3	11.375	11.938	7.875	8.75	2.25

COLORS: LEGEND — BLACK
BACKGROUND— YELLOW (RETROREFLECTIVE)

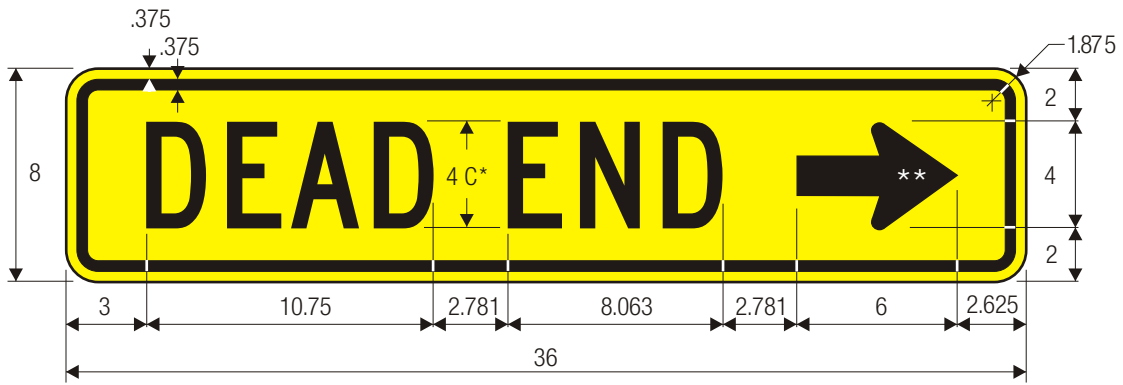

W14-1aR

DEAD END



W14-1aL

DEAD END

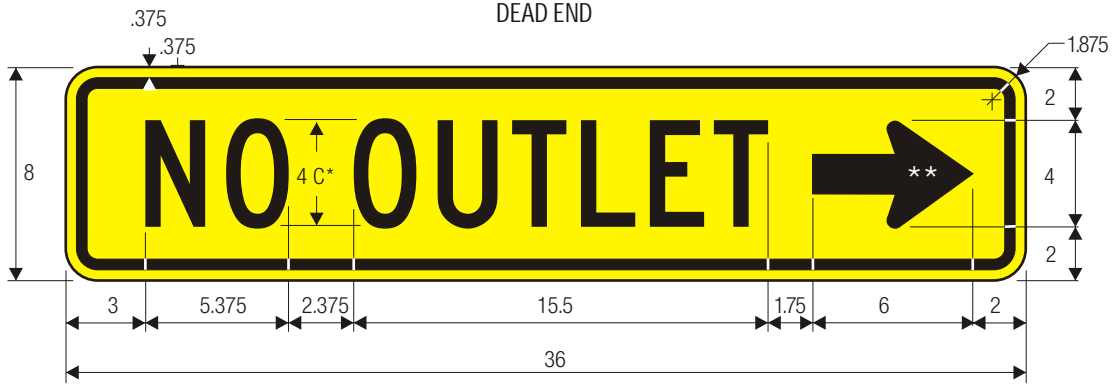

W14-2aR

NO OUTLET



W14-2aL

NO OUTLET

*Series 2000 Standard Alphabets.
 **See page 6-2 for symbol design.

COLORS: LEGEND — BLACK
 BACKGROUND — YELLOW (RETROREFLECTIVE)

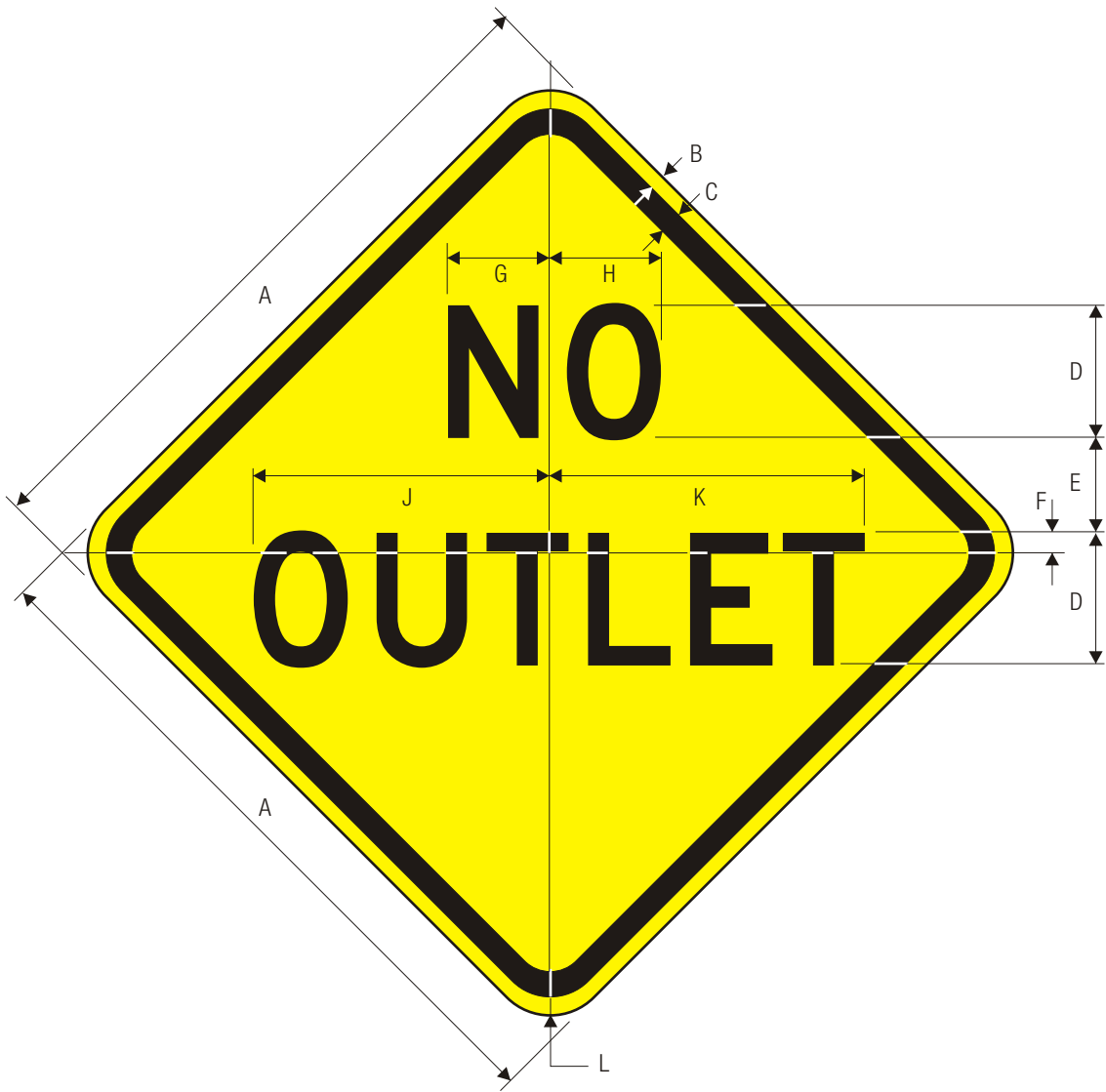

W14-2
NO OUTLET

C

A	B	C	D	E	F	G	H	J	K	L
24	.375	.625	5 D	3	.75	4.125	4.5	11.625	12.063	1.5
30	.5	.75	6 D	4	.938	5	5.375	13.938	14.5	1.875
36	.625	.875	7 D	5	1.125	5.875	6.25	16.25	16.938	2.25

COLORS: LEGEND — BLACK
BACKGROUND— YELLOW (RETROREFLECTIVE)



W14-3
NO PASSING ZONE

*Reduce spacing 20% for 48" size.
 **Reduce spacing 35% for 48" size.
 ***Use Series 2000 Alphabets for 36" size.

A	B	C	D	E	F	G	H	J	K	L	M	N
36	24	.5	.75	5.75	3 D	3 C	1.75	2.375	1.875	4	15.75	8.313
40	30	.5	.75	7.25	4 D	4 C	1.75	2.5	1.875	6.5	22.563	11.063
48	36	.625	.875	8.5	5 D	5 C	2	3	2.25	8	268.13	12.75
64	48	.75	1.25	12	6 D	6 C	3	4	3	10.75	33.688	16.563

WARNING SIGN COLORS:

LEGEND — BLACK
 BACKGROUND — YELLOW (RETROREFLECTIVE)

TTC SIGN COLORS:

LEGEND — BLACK
 BACKGROUND — ORANGE (RETROREFLECTIVE)

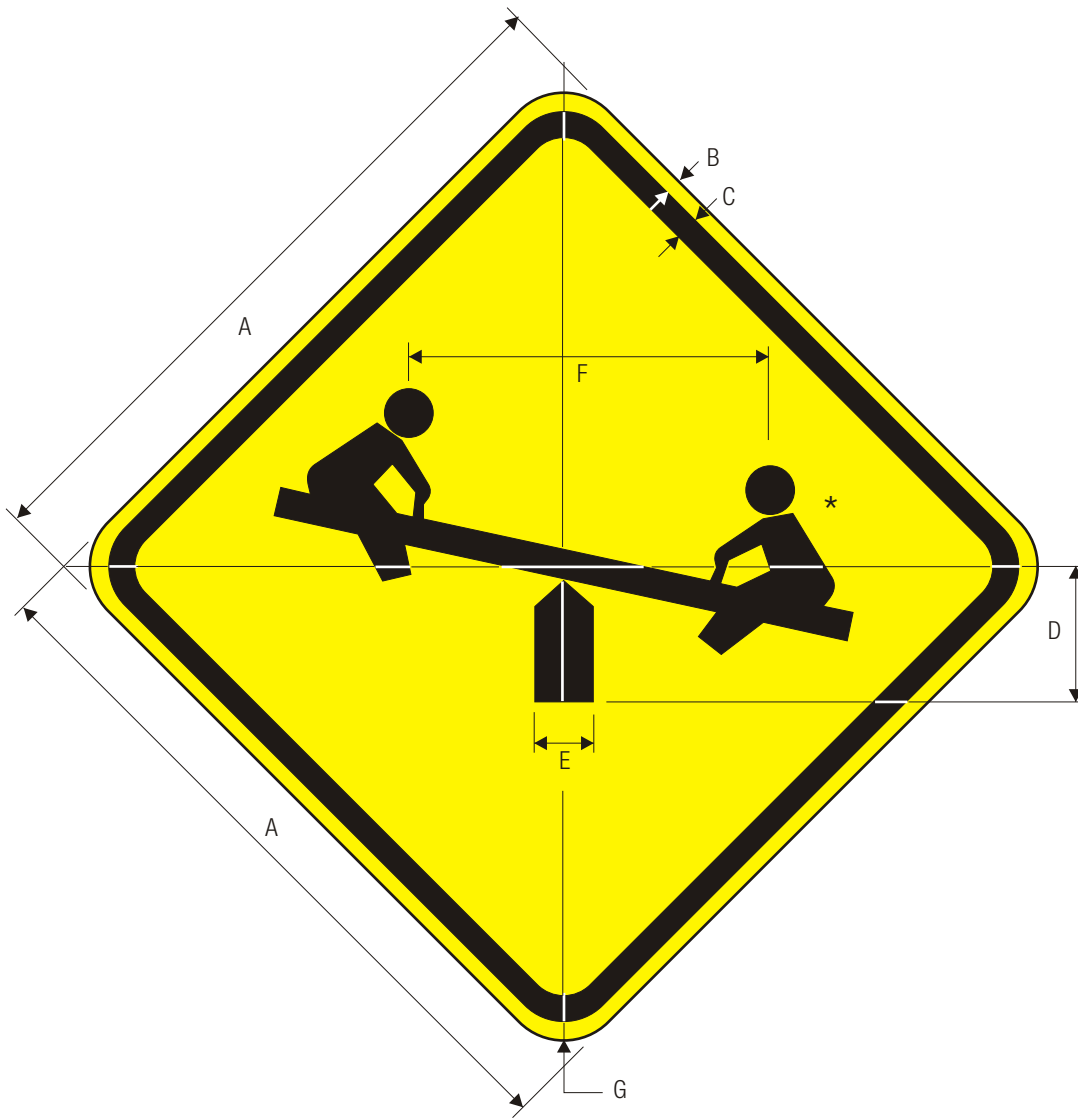

W15-1
PLAYGROUND

*See page 6-34 for symbol design.
**Option.

	A	B	C	D	E	F	G
	18	.375	.625	3.5	1.5	9.312	1.5
	24	.375	.625	4.6	2	12.4	1.5
C	30	.5	.75	5.75	2.5	15.5	1.875
	36	.625	.875	7	3	18.625	2.25

COLORS: SYMBOL — BLACK
 BACKGROUND — YELLOW (RETROREFLECTIVE)
 — FLOURESCENT YELLOW GREEN (RETROREFLECTIVE)



W16-1

Note: For use with Warning Signs for slower forms of transportation such as the Bicycle, Golf Cart, Farm Machinery, Horse Drawn Vehicle and ATV Warning Signs.

	A	B	C	D	E	F	G	H	J	K	L
C	18	24	.375	.625	3.5	4 C	2.5	6.865	3.862	5.505	1.5
	24	30	.375	.625	4.25	5 C	3.25	8.586	4.823	6.885	1.5

COLORS: LEGEND BLACK
BACKGROUND YELLOW (RETROREFLECTIVE)

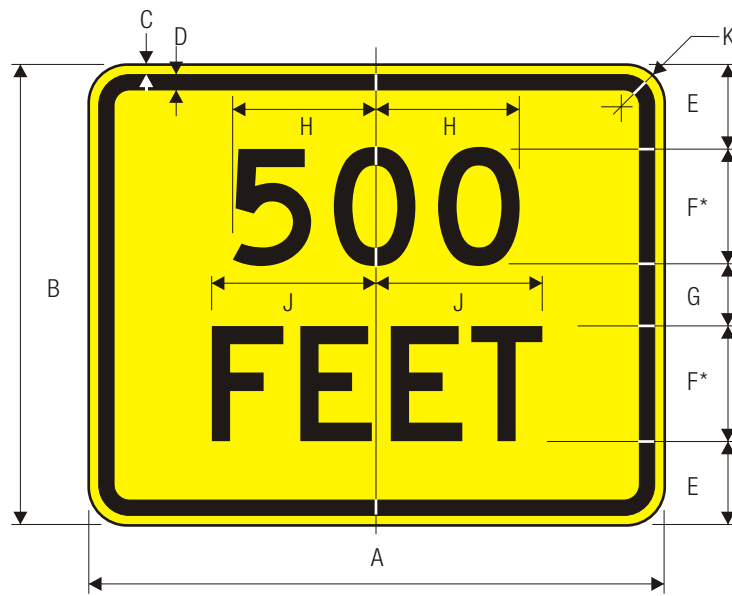

W16-2

500 FEET (2 LINE) (ENGLISH)

C

A	B	C	D	E	F	G	H	J	K
18	12	.375	.625	2	3 D	2	VAR	4.303	1.5
24	18	.375	.625	3	5 D	2	VAR	7.185	1.5
30	24	.375	.625	4.375	6 D	3.25	VAR	8.606	1.875

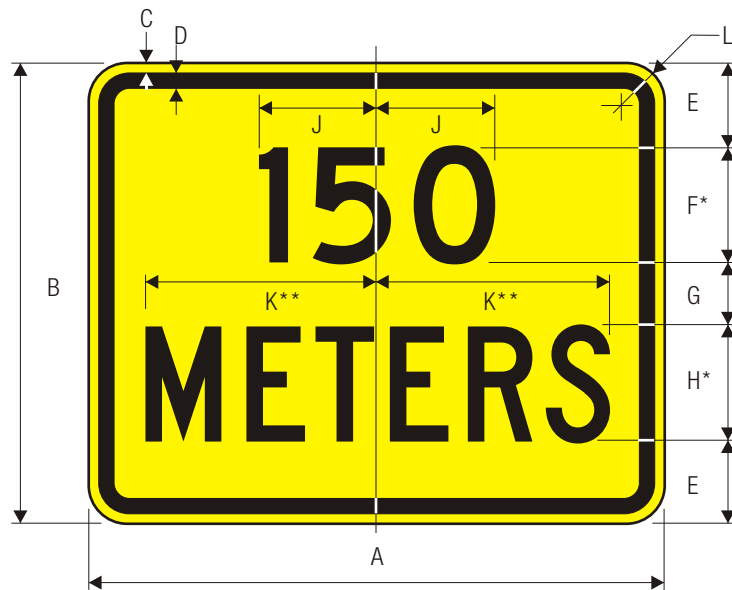

W16-2

150 METERS (2 LINE) (METRIC)

*Series 2000 Standard Alphabets.
**Reduce spacing to fit on 24" size.

C

A	B	C	D	E	F	G	H	J	K	L
18	12	.375	.625	2	3 D	2	3 C	VAR	6.049	1.5
24	18	.375	.625	3	5 D	2	5 C	VAR	9.627	1.5
30	24	.375	.625	4.375	6 D	3.25	6 C	VAR	12.109	1.875

WARNING SIGN COLORS:
LEGEND — BLACK
BACKGROUND— YELLOW (RETROREFLECTIVE)

TTC SIGN COLORS:
LEGEND — BLACK
BACKGROUND— ORANGE (RETROREFLECTIVE)

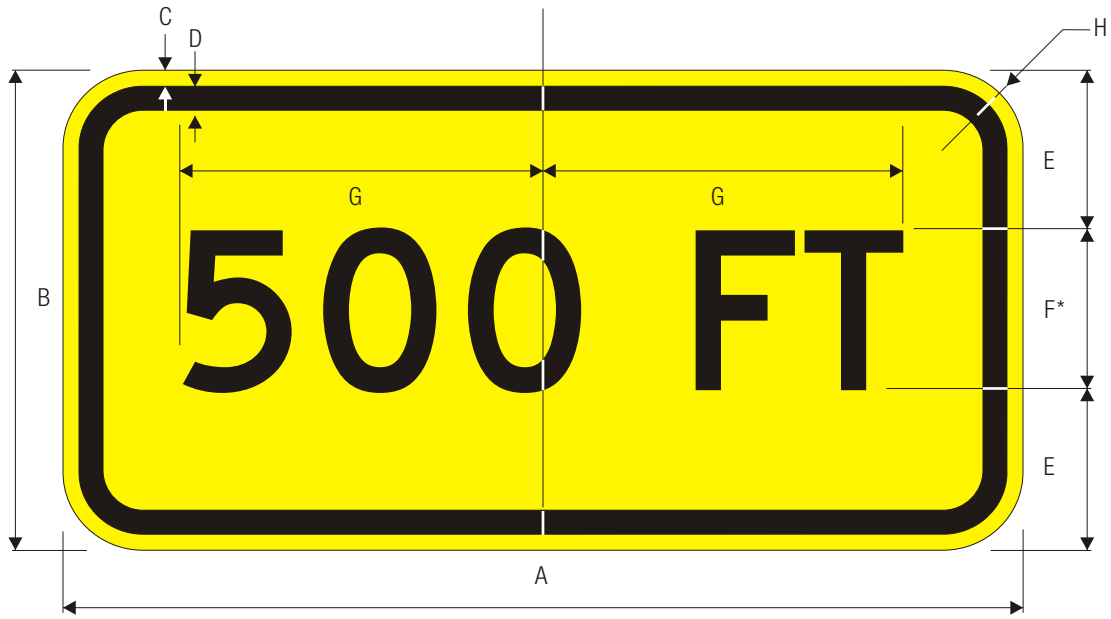

W16-2a

500 FT (1 LINE) (ENGLISH)

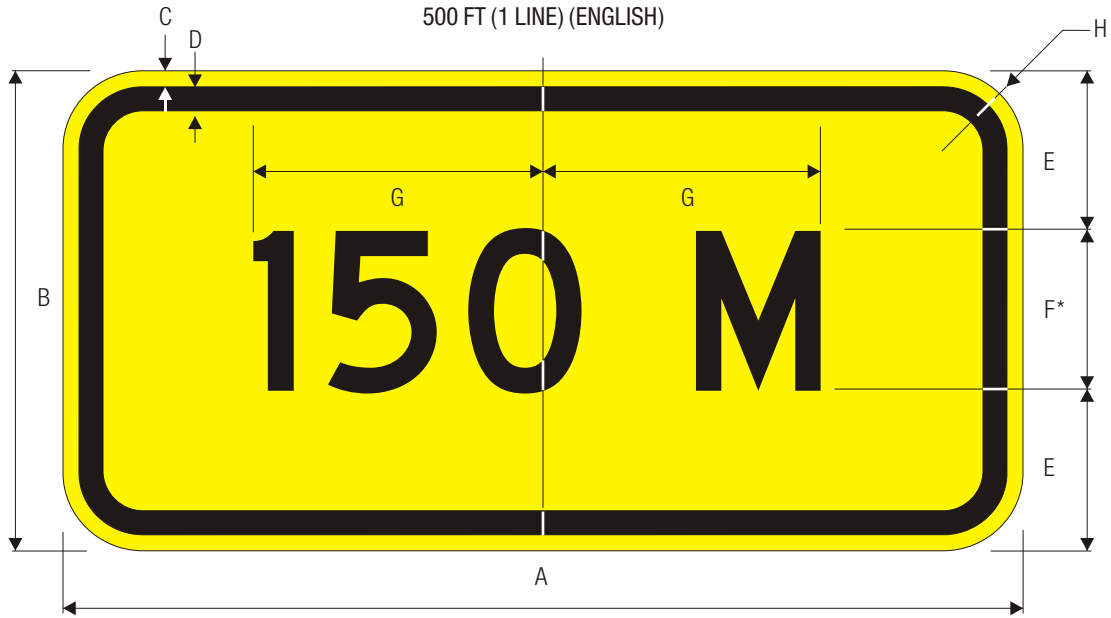

W16-2a Metric

150 M (1 LINE) (METRIC)

*Series 2000 Standard Alphabets.

	A	B	C	D	E	F	G	H
C	24	12	.375	.625	4	4 D	VAR	1.5
	30	18	.5	.75	6.5	5 D	VAR	1.875

COLORS: LEGEND — BLACK
 BACKGROUND — YELLOW (RETROREFLECTIVE)

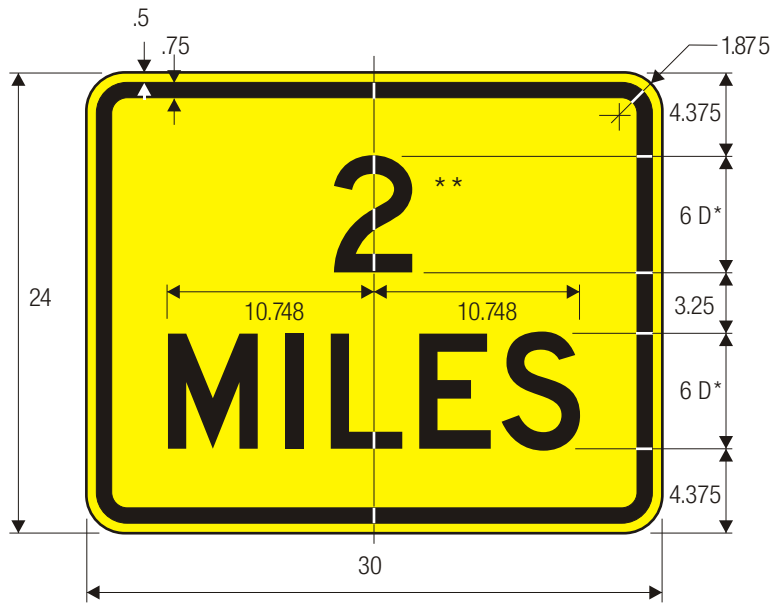

W16-3

2 MILES (2 LINE) (ENGLISH)

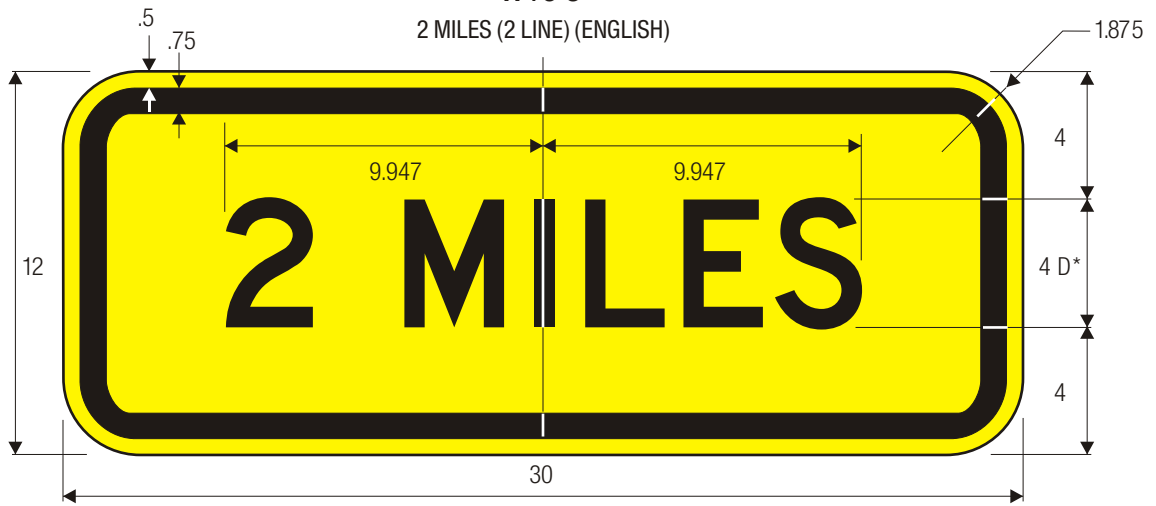

W16-3a

2 MILES (1 LINE) (ENGLISH)

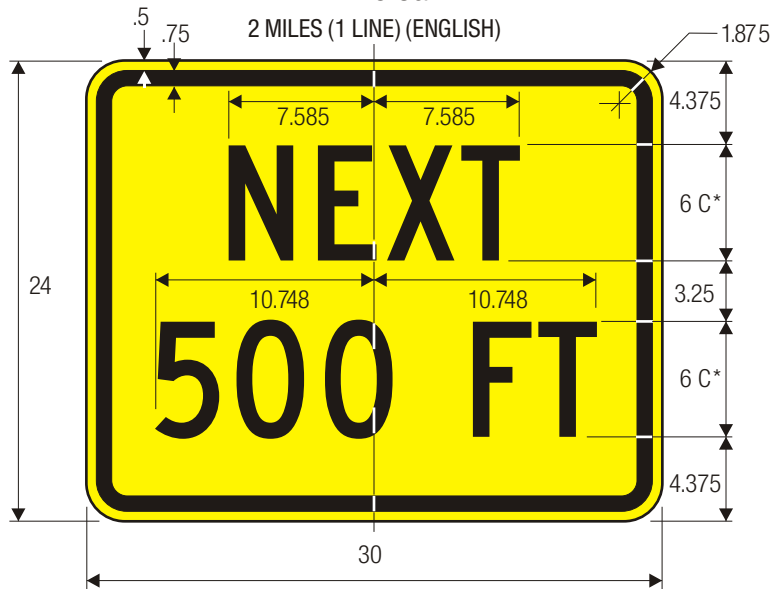

W16-4

500 FT (2 LINE) (ENGLISH)

*Series 2000 Standard Alphabets.

**Optically locate numerals about centerline.

COLORS: LEGEND — BLACK
 BACKGROUND — YELLOW (RETROREFLECTIVE)



W16-5pR
ARROW PLAQUE

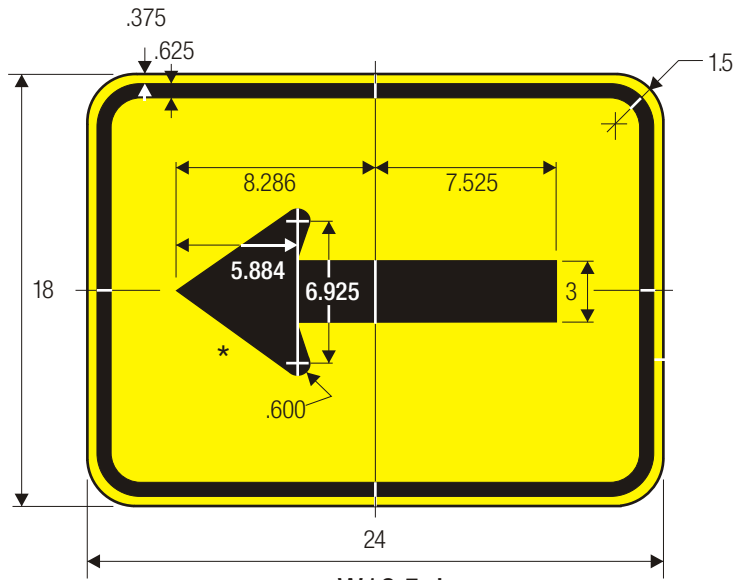

W16-5pL
ARROW PLAQUE

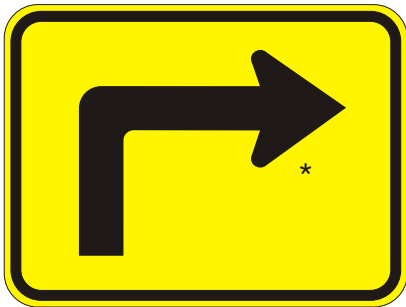

W16-6pR
ARROW PLAQUE

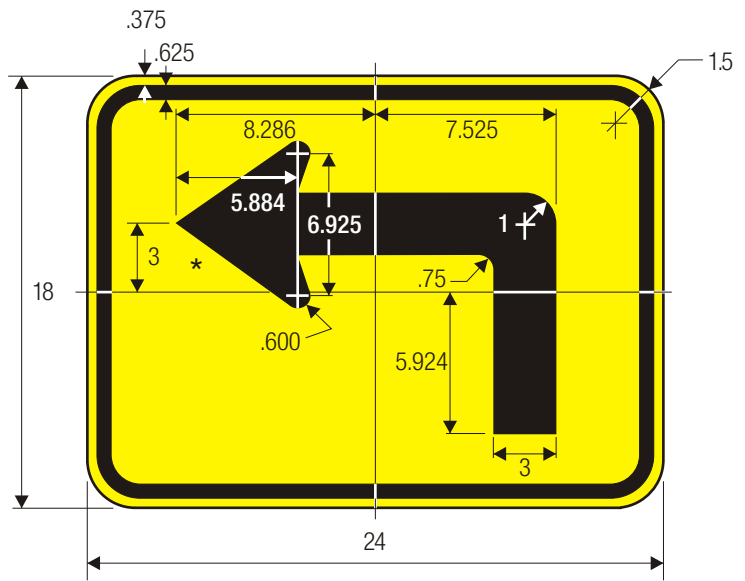

W16-6pL
ARROW PLAQUE

*See page 6-2 for arrow design.

COLORS: SYMBOL — BLACK
BACKGROUND — YELLOW (RETROREFLECTIVE)

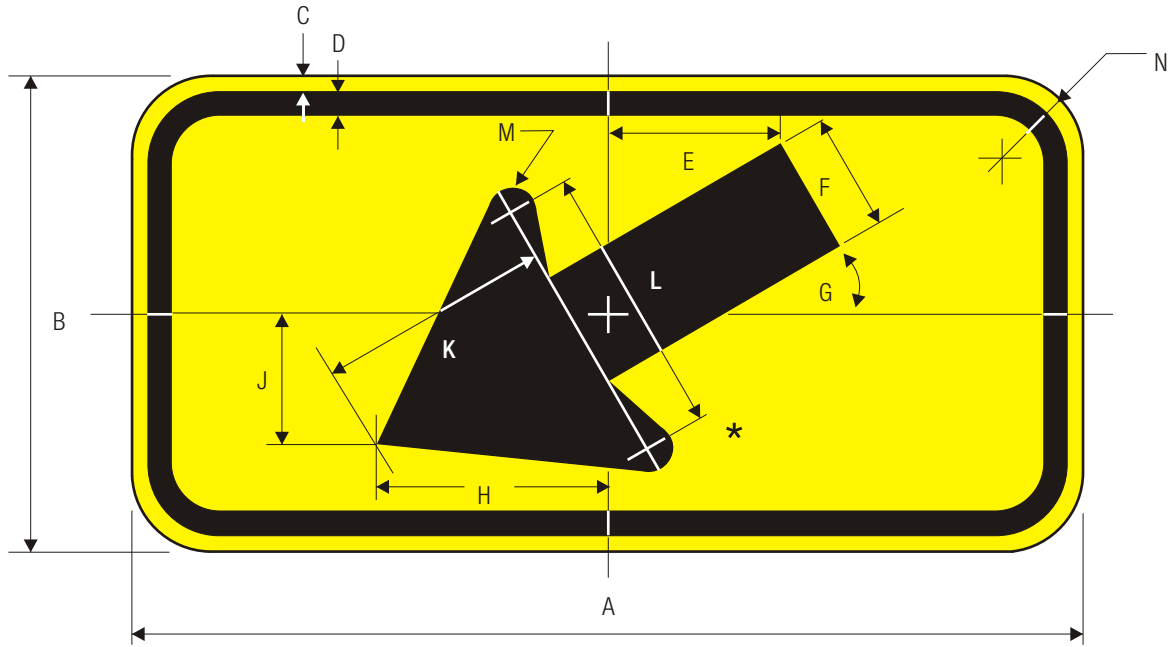

W16-7pL
LEFT DIAGONAL ARROW PLAQUE

C

A	B	C	D	E	F	G	H	J	K	L	M	N
24	12	.375	.625	4.323	3	30°	5.844	3.282	5.884	6.925	.600	1.5
30	18	.5	.75	6.524	4.5	30°	8.766	4.923	8.846	10.407	.920	1.875



W16-7pR
RIGHT DIAGONAL ARROW PLAQUE

*See page 6-2 for arrow design.

COLORS: SYMBOL — BLACK
BACKGROUND — YELLOW (RETROREFLECTIVE)

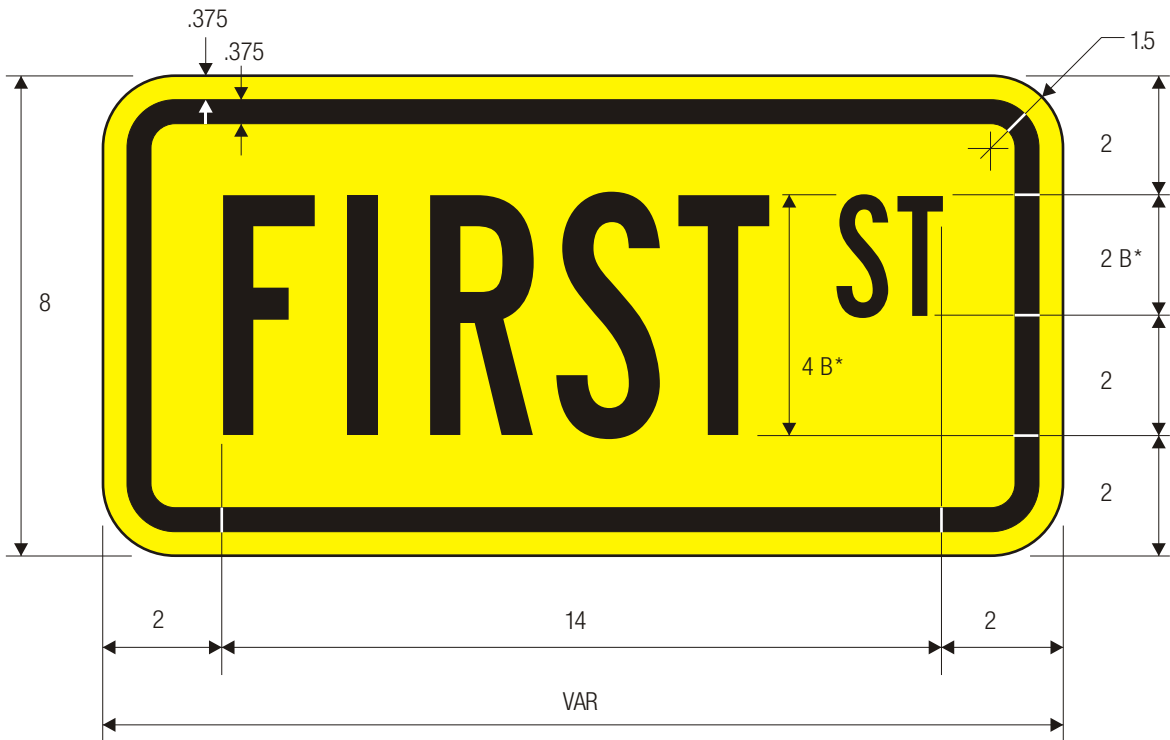

W16-8

ADVANCE STREET NAME PLAQUE

*Series 2000 Standard Alphabets.

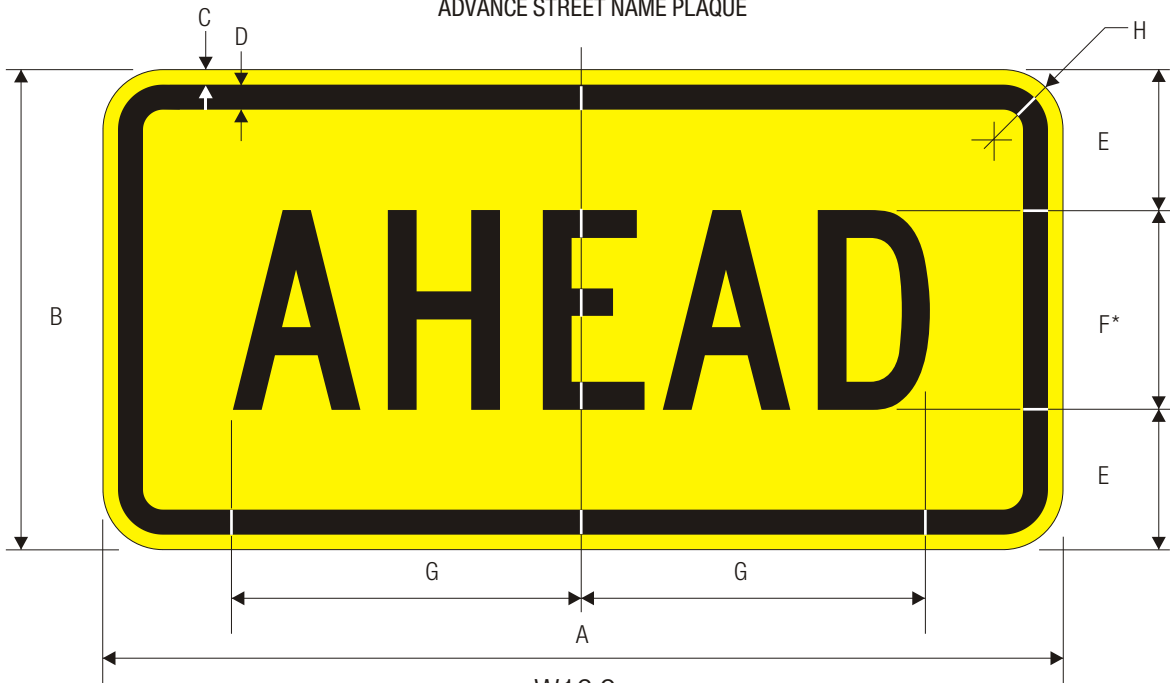

W16-9p

AHEAD PLAQUE

	A	B	C	D	E	F	G	H
C	24	12	.375	.625	3.5	5 C	8.714	1.5
	30	18	.5	.75	5.5	7 C	12.201	1.875
	36	24	.625	.875	8	8 C	13.944	2.25
	48	36	.75	1.25	13	10 C	17.428	3

COLORS: LEGEND — BLACK
 BACKGROUND— YELLOW (RETROREFLECTIVE)



W16-8a
 ADVANCE STREET NAME PLAQUE

*Series 2000 Standard Alphabets.

WARNING SIGN COLORS:
 LEGEND — BLACK
 BACKGROUND— YELLOW (RETROREFLECTIVE)

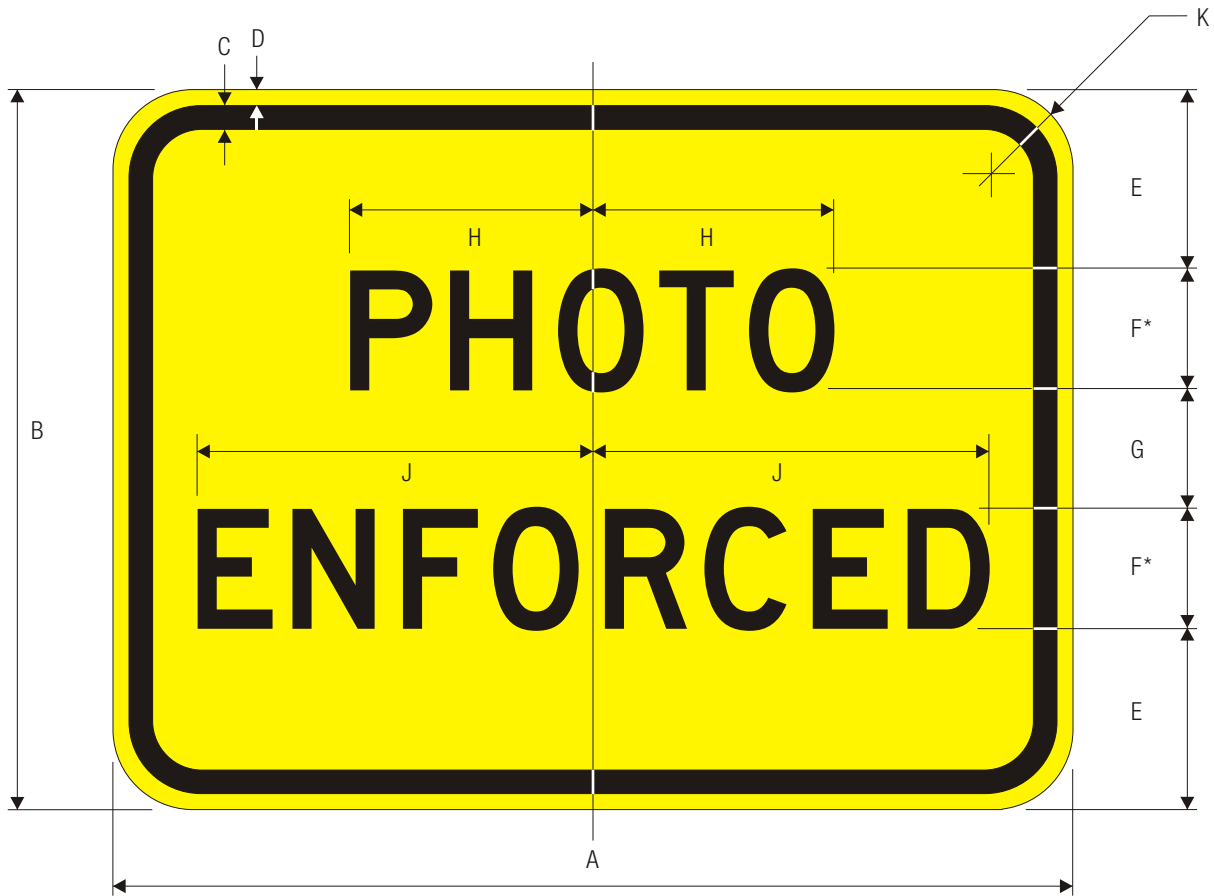

W16-10
PHOTO ENFORCED

*Series 2000 Standard Alphabets.

	A	B	C	D	E	F	G	H	J	K
C	24	18	.375	.625	4.5	3 D	3	6.018	9.843	1.5
	36	24	.625	.875	6	4 D	4	8.023	13.121	2.25
	48	36	.75	1.25	9	6 D	6	12.034	19.682	3

COLORS: LEGEND — BLACK
BACKGROUND— YELLOW (RETROREFLECTIVE)

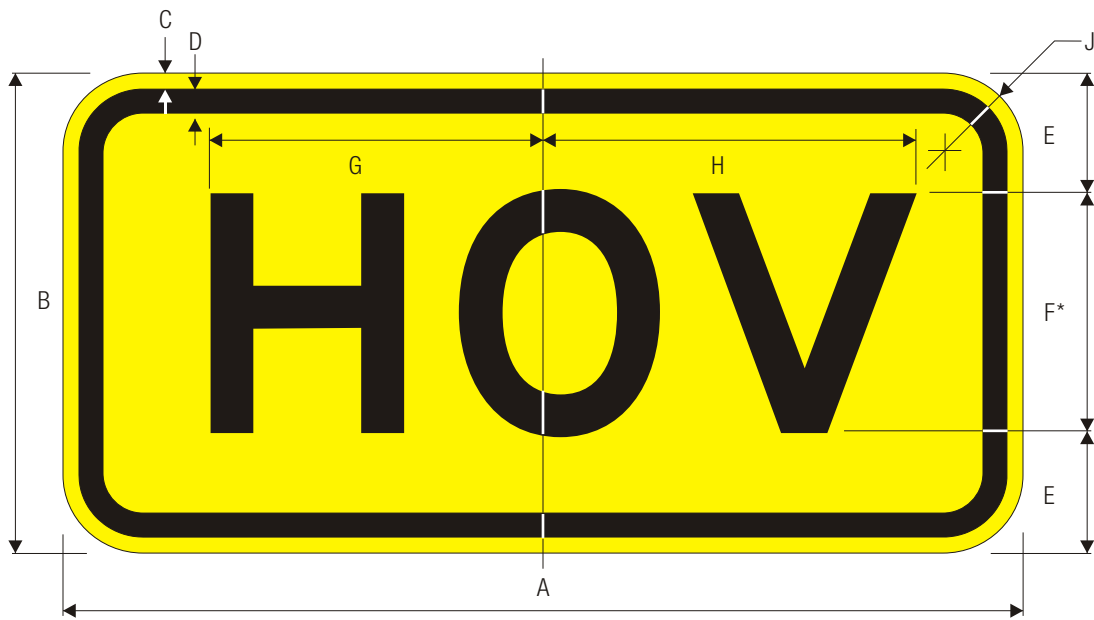

W16-11
HOV

For use with a Warning Sign that applies to the HOV Lane.

*Series 2000 Standard Alphabets.

	A	B	C	D	E	F	G	H	J
C	24	12	.375	.625	3	6 E	8.339	9.313	1.5
	30	18	.5	.75	5	8 E	11.244	12.289	1.875

COLORS: LEGEND — BLACK
BACKGROUND — YELLOW (RETROREFLECTIVE)

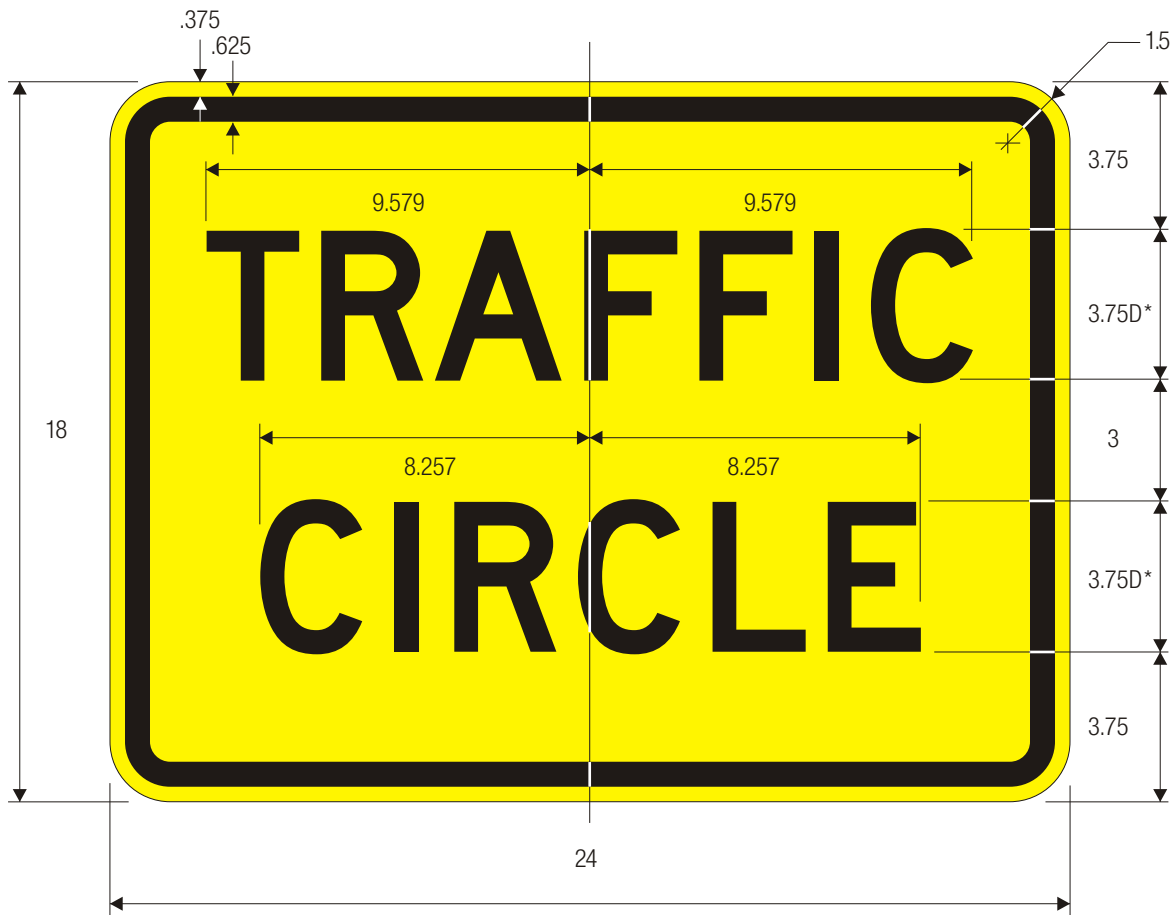

W16-12p

TRAFFIC CIRCLE PLAQUE

*Series 2000 Standard Alphabets.

WARNING SIGN COLORS:

LEGEND — BLACK
 BACKGROUND — YELLOW (RETROREFLECTIVE)

TTC SIGN COLORS:

LEGEND — BLACK
 BACKGROUND — ORANGE (RETROREFLECTIVE)

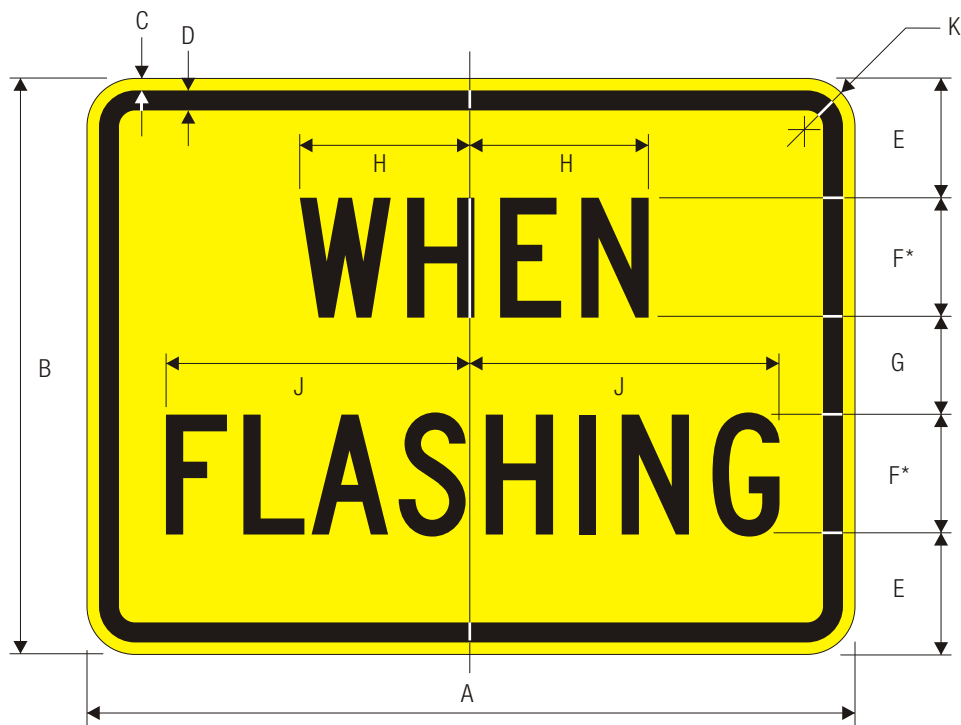

W16-13

WHEN FLASHING

*Series 2000 Standard Alphabets

For use with W3-4 BE PREPARED TO STOP sign.

A	B	C	D	E	F	G	H	J	K
24	18	.375	.625	3.75	3.75 C	3	5.451	9.584	1.5
30	24	.5	.75	5	5 C	3	7.268	12.782	1.875

COLORS: LEGEND — BLACK
 BACKGROUND— YELLOW (RETROREFLECTIVE)

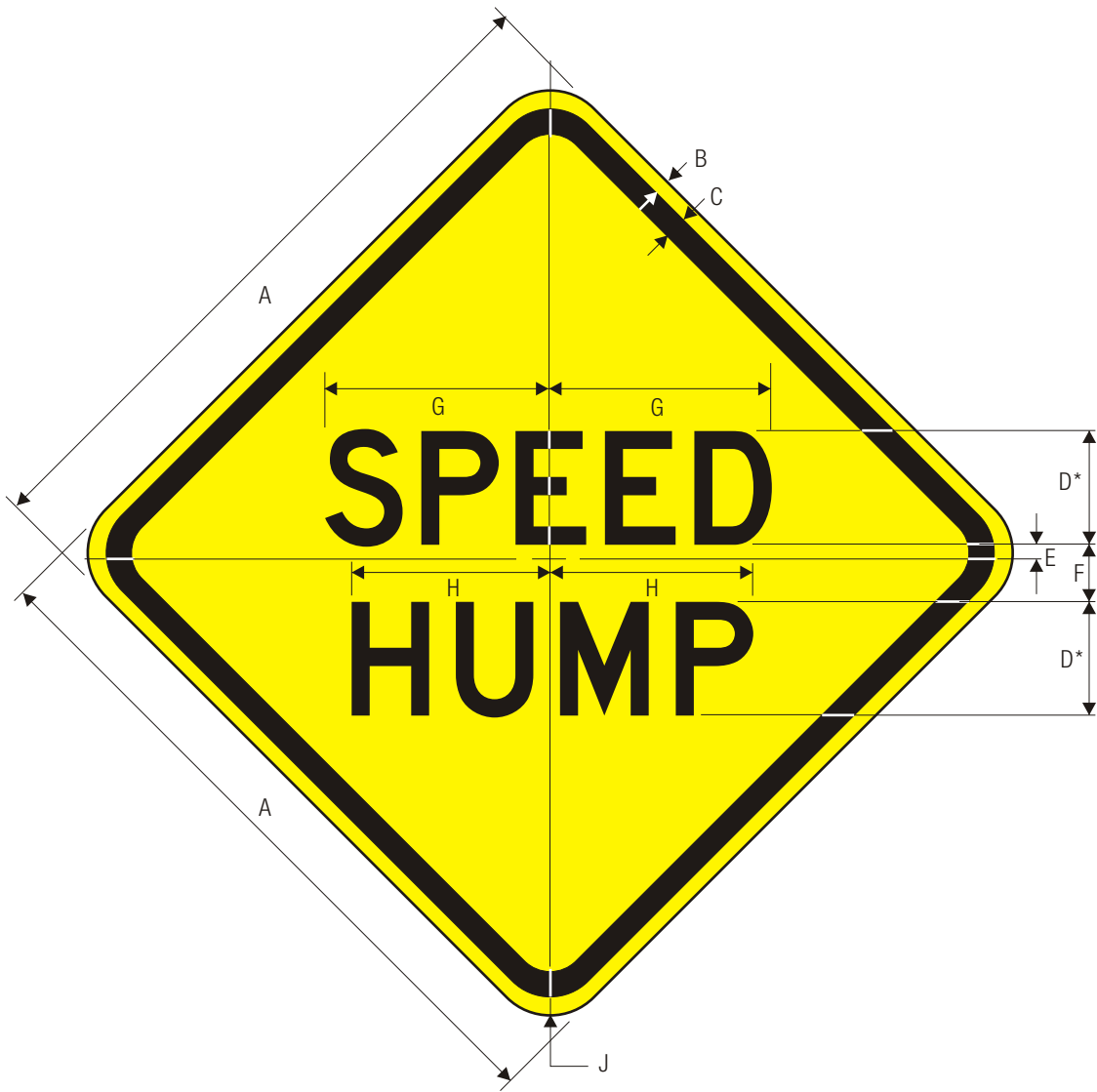

W17-1
SPEED HUMP

*Series 2000 Standard Alphabets.

	A	B	C	D	E	F	G	H	J
	24	.375	.625	4 D	.25	2	7.845	7.045	1.5
C	30	.5	.75	5 D	.5	2.5	9.827	8.826	1.875
	36	.625	.875	6 D	.75	3	11.788	10.588	2.25

COLORS: LEGEND — BLACK
BACKGROUND— YELLOW (RETROREFLECTIVE)



W18-1

NO TRAFFIC SIGNS

*Series 2000 Standard Alphabets.

	A	B	C	D	E	F	G	H	J	K
	24	.375	.625	4 D	2.5	1.25	3.205	10.218	7.286	1.5
C	30	.5	.75	5 D	3.125	1.5	4	12.771	9.107	1.875
	36	.625	.875	6 D	3.75	1.8	4.807	15.327	10.93	2.25

COLORS: LEGEND — BLACK
 BACKGROUND— YELLOW (RETROREFLECTIVE)



W25-1

ONCOMING TRAFFIC HAS EXTENDED GREEN

*Series 2000 Standard Alphabets.

COLORS: LEGEND — BLACK
 BACKGROUND — YELLOW (RETROREFLECTIVE)



W25-2

ONCOMING TRAFFIC MAY HAVE EXTENDED GREEN

*Series 2000 Standard Alphabets.

COLORS: LEGEND — BLACK
 BACKGROUND — YELLOW (RETROREFLECTIVE)

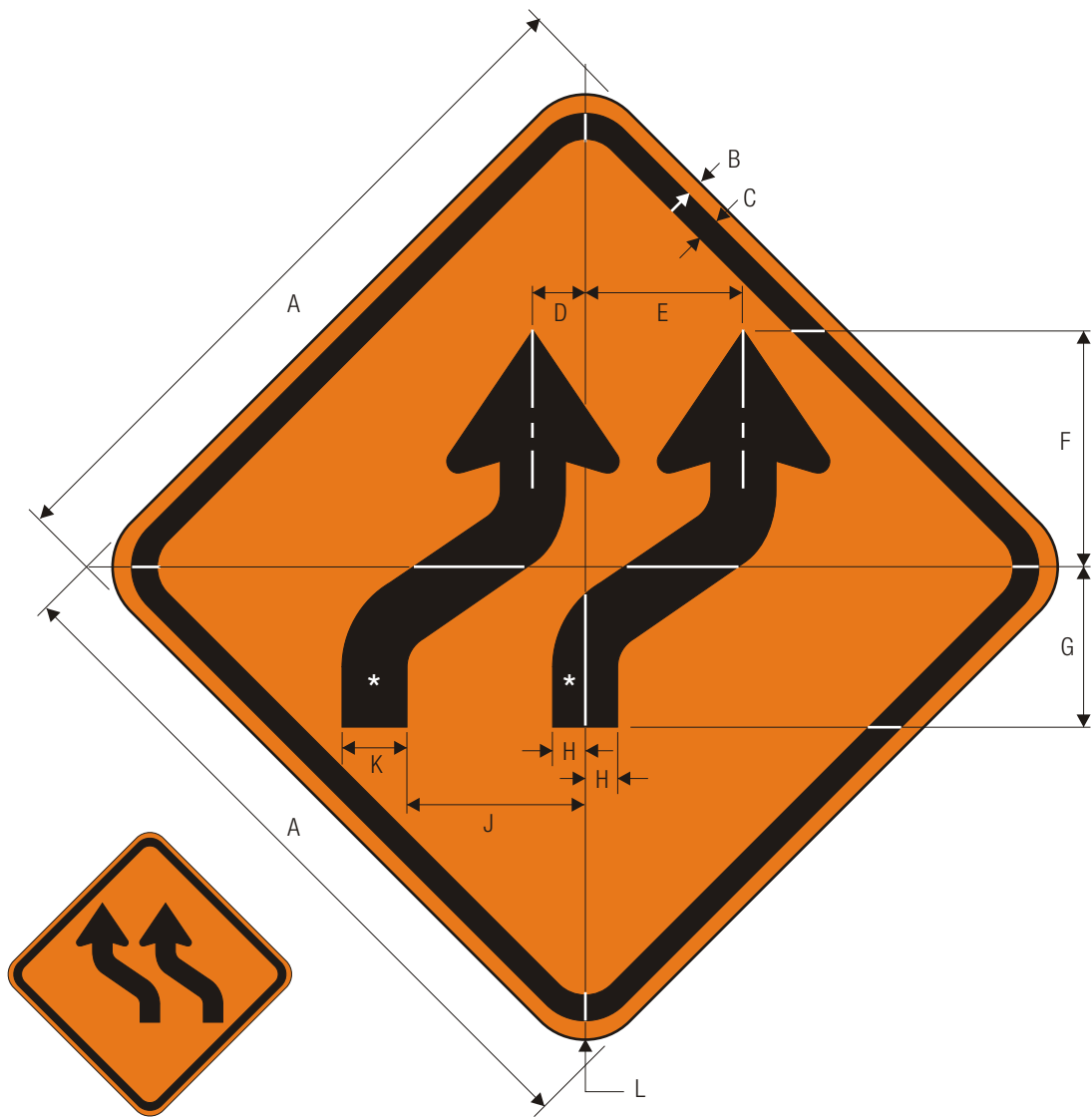

W1-4bL

W1-4bR

TWO LANE REVERSE CURVE

*Reduce W1-4 Arrow 30%.

**See page 6-2 for arrow design.

C

A	B	C	D	E	F	G	H	J	K	L
24	.375	.625	2.121	5.123	7.685	5.123	1.040	6.164	2.080	1.5
30	.5	.75	2.241	6.805	10.247	6.805	1.401	7.645	2.802	1.875
36	.625	.875	3.042	8.526	12.889	8.446	1.741	9.847	3.482	2.25
48	.75	1.25	4.242	10.246	15.37	10.246	2.08	12.328	4.16	3

TTC SIGN COLORS:

LEGEND — BLACK

BACKGROUND— ORANGE (RETROREFLECTIVE)

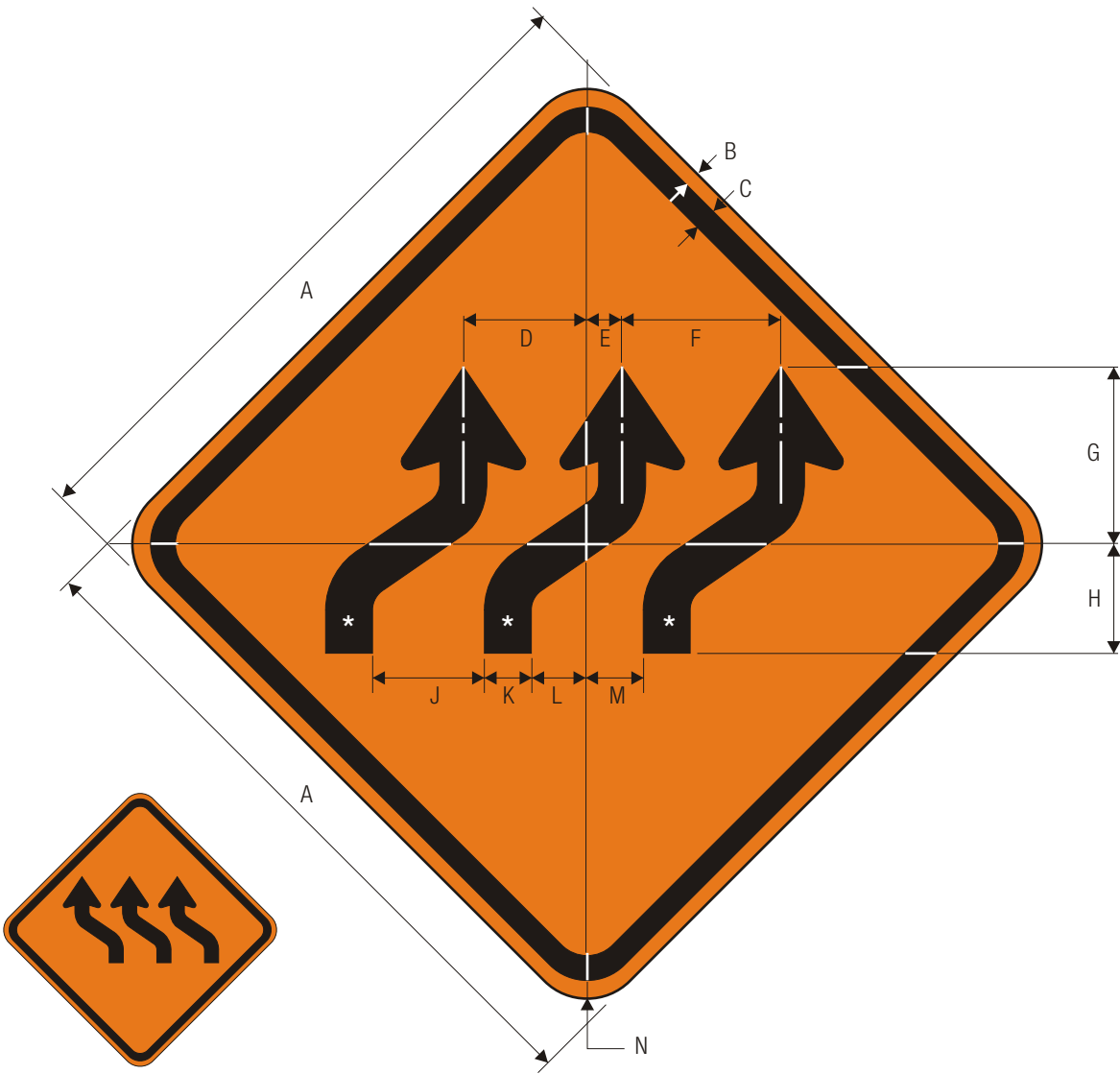

W1-4cL

W1-4cR
THREE LANE REVERSE CURVE

*Reduce W1-4bR Arrow 20%.

	A	B	C	D	E	F	G	H	J	K	L	M	N
	24	.375	.625	4.443	1.240	5.684	6.404	3.842	4	1.681	2	2	1.5
	30	.5	.75	5.404	1.481	7.245	8.566	5.123	5	2.241	2.862	2.141	1.875
C	36	.625	.875	7.125	1.641	9.287	10.768	6.284	6.484	2.802	3.762	2.722	2.25
	48	.75	1.25	8.886	2.48	11.368	12.808	7.684	8	3.362	4	4	3

TTC SIGN COLORS:
 LEGEND — BLACK
 BACKGROUND— ORANGE (RETROREFLECTIVE)

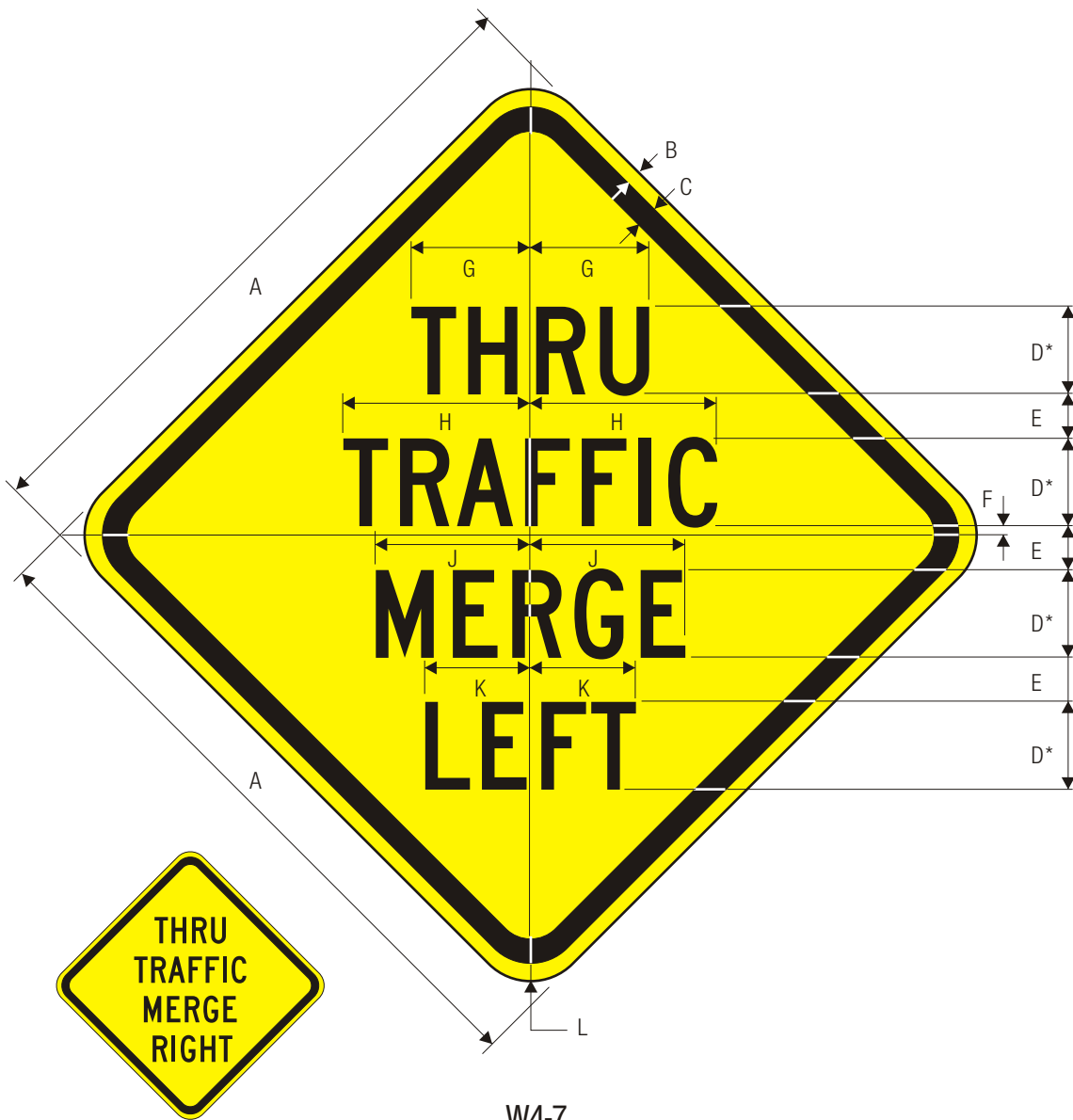

W4-7

W4-7
THRU TRAFFIC MERGE LEFT

*Series 2000 Standard Alphabets.

A	B	C	D	E	F	G	H	J	K	L
30	.5	.75	4 C	2	.480	5.424	8.526	7.045	4.803	1.875
36	.625	.875	5 C	2.401	.560	6.765	10.648	8.826	6	2.25
48	.75	1.25	6 C	3	.720	8.126	12.789	10.588	7.205	3
60	.75	1.25	8 C	4	.960	10.828	17.032	14.110	9.607	3

WARNING SIGN COLORS:

LEGEND — BLACK
BACKGROUND — YELLOW (RETROREFLECTIVE)

TTC SIGN COLORS:

LEGEND — BLACK
BACKGROUND — ORANGE (RETROREFLECTIVE)

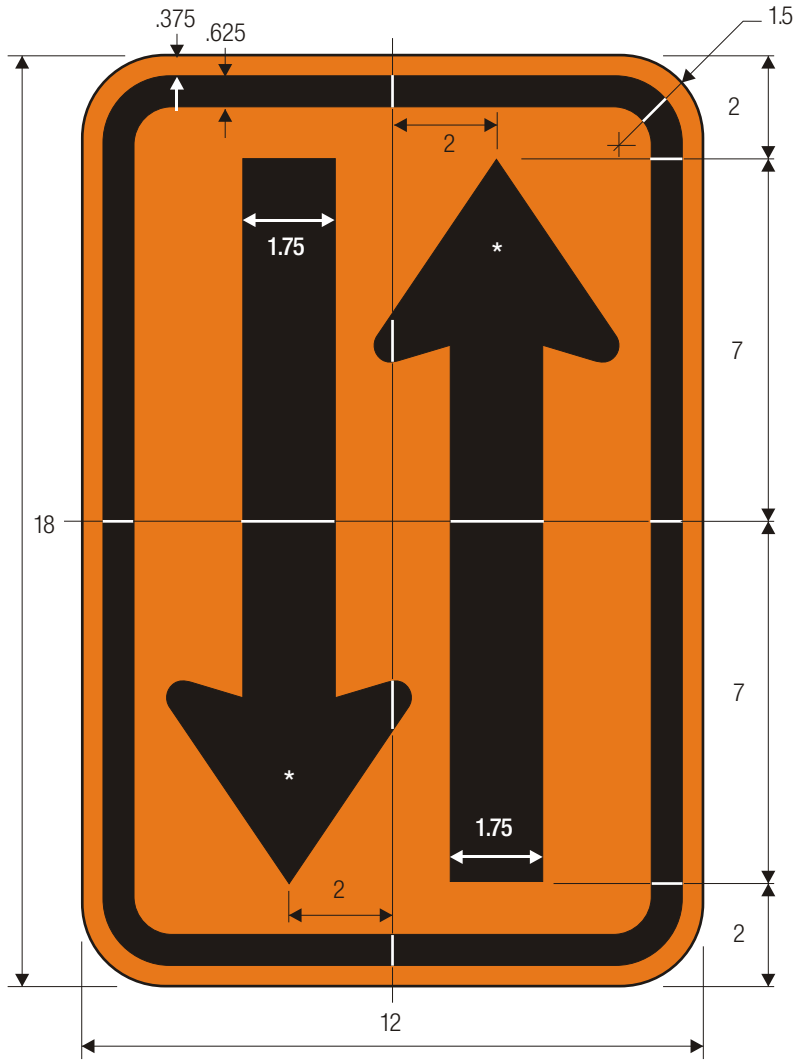

W6-4

TWO WAY TRAFFIC

*See page 6-2 for arrow design.

TTC SIGN COLORS:

SYMBOL — BLACK

BACKGROUND— ORANGE (RETROREFLECTIVE)

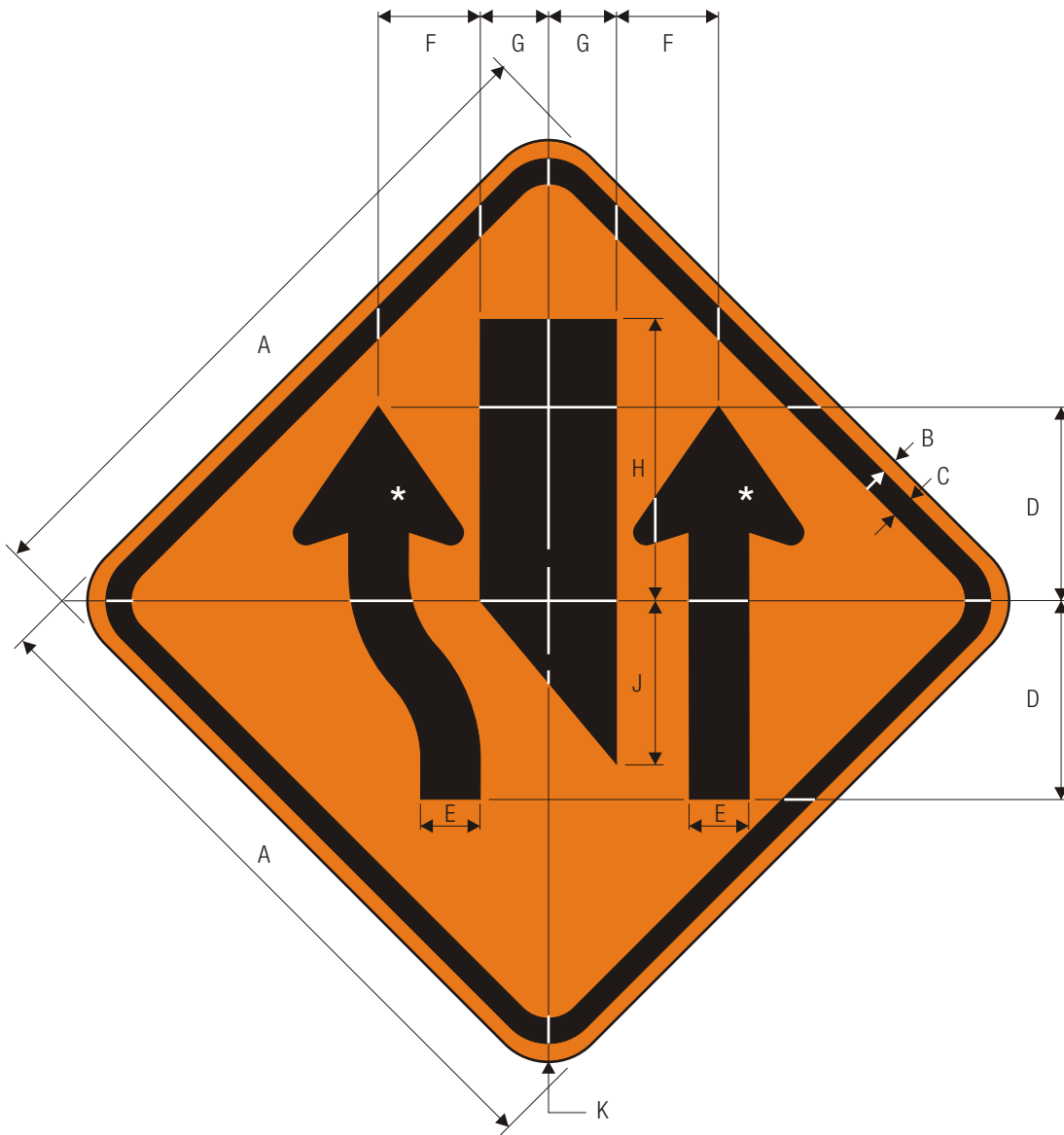

W9-3a

CENTER LANE CLOSED

*See page 6-2 for symbol design.

	A	B	C	D	E	F	G	H	J	K
	24	.375	.625	6.925	2.121	3.602	2.401	10	5.684	1.5
	30	.5	.75	8.646	2.642	4.523	3	12.529	7.125	1.875
C	36	.625	.875	10.367	5.444	3.602	15.051	15.051	8.566	2.25
	48	.75	1.25	13.810	4.203	7.245	4.803	20.055	11.408	3

TTC SIGN COLORS:

SYMBOL — BLACK

BACKGROUND— ORANGE (RETROREFLECTIVE)

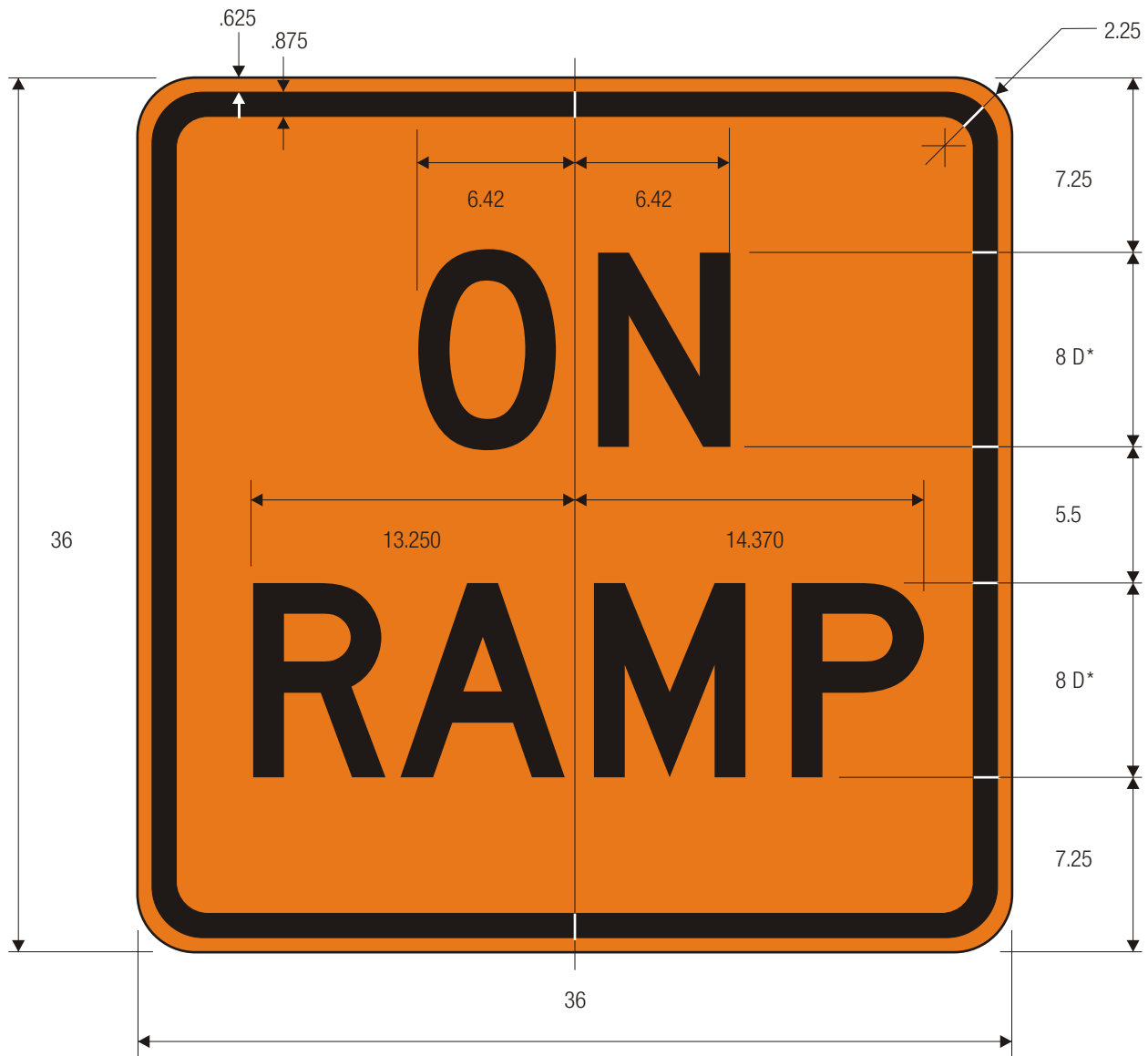

W13-4

ON RAMP

*Series 2000 Standard Alphabets.

TTC SIGN COLORS:

LEGEND — BLACK

BACKGROUND— ORANGE (RETROREFLECTIVE)

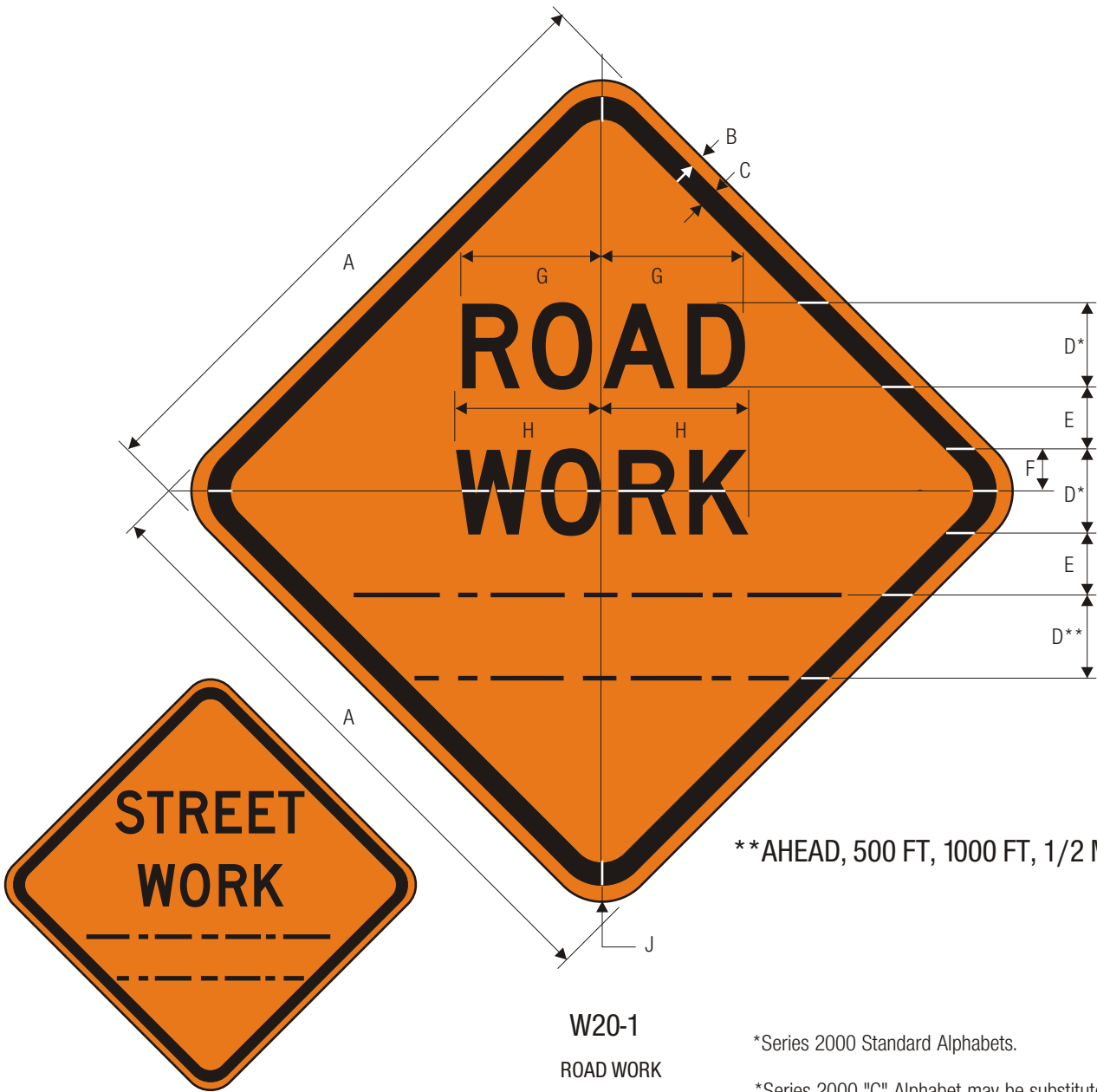

**AHEAD, 500 FT, 1000 FT, 1/2 MILE

W20-1
ROAD WORK

*Series 2000 Standard Alphabets.

*Series 2000 "C" Alphabet may be substituted where space limitations occur due to length of word message.

	A	B	C	D	E	F	G	H	J
	24	.375	.625	4 D	2	2	6.685	6.965	1.5
	30	.5	.75	4 D	2.742	2	6.685	6.965	1.875
C	36	.625	.875	5 D	3.682	2.481	8.406	8.666	2.25
	48	.75	1.25	7 D	4.803	3.482	11.688	11.788	3
	60	.75	1.25	8 D	5.484	4	13.370	13.930	3

TTC SIGN COLORS:
 LEGEND — BLACK
 BACKGROUND— ORANGE (RETROREFLECTIVE)

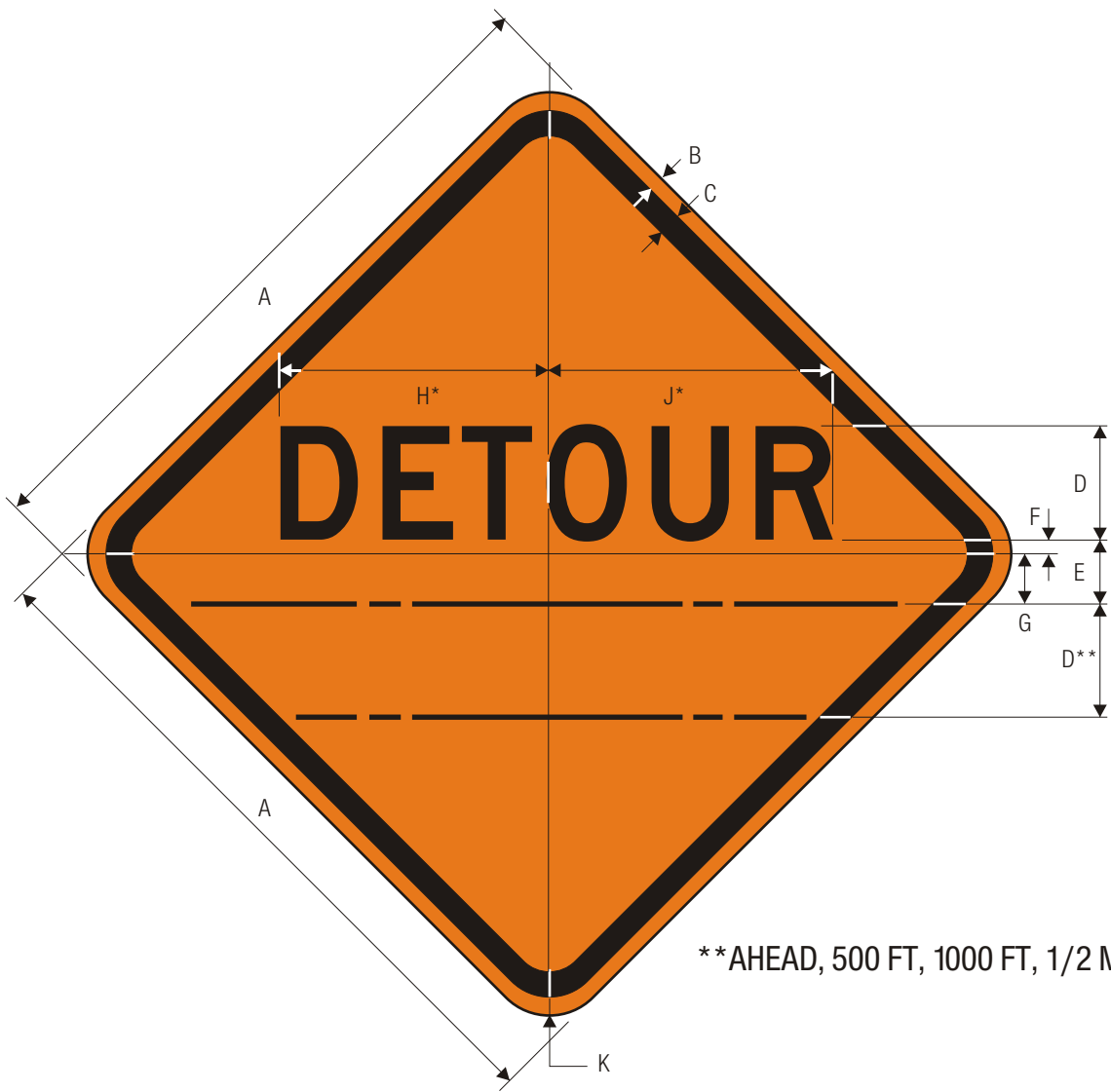

**AHEAD, 500 FT, 1000 FT, 1/2 MILE

W20-2
DETOUR

*Reduce spacing 40%.

	A	B	C	D	E	F	G	H	J	K
C	36	.625	.875	6 D	3.5	.875	2.625	13.5	13.75	2.25
	48	.75	1.25	8 D	4.75	1.25	3.5	18	18.438	3

TTC SIGN COLORS:
 LEGEND — BLACK
 BACKGROUND— ORANGE (RETROREFLECTIVE)



C

A	B	C	D	E	F	G	H	J	K	L	M
36	.625	.875	5 D	3.5	3.75	3.25	8.375	8.875	12.313	2.25	10
48	.75	1.25	7 D	4.75	5.25	4.5	11.688	12.438	17.25	3	14

N	P
9.625	5 C
13.5	7 C

TTC SIGN COLORS:
 LEGEND — BLACK
 BACKGROUND— ORANGE (RETROREFLECTIVE)

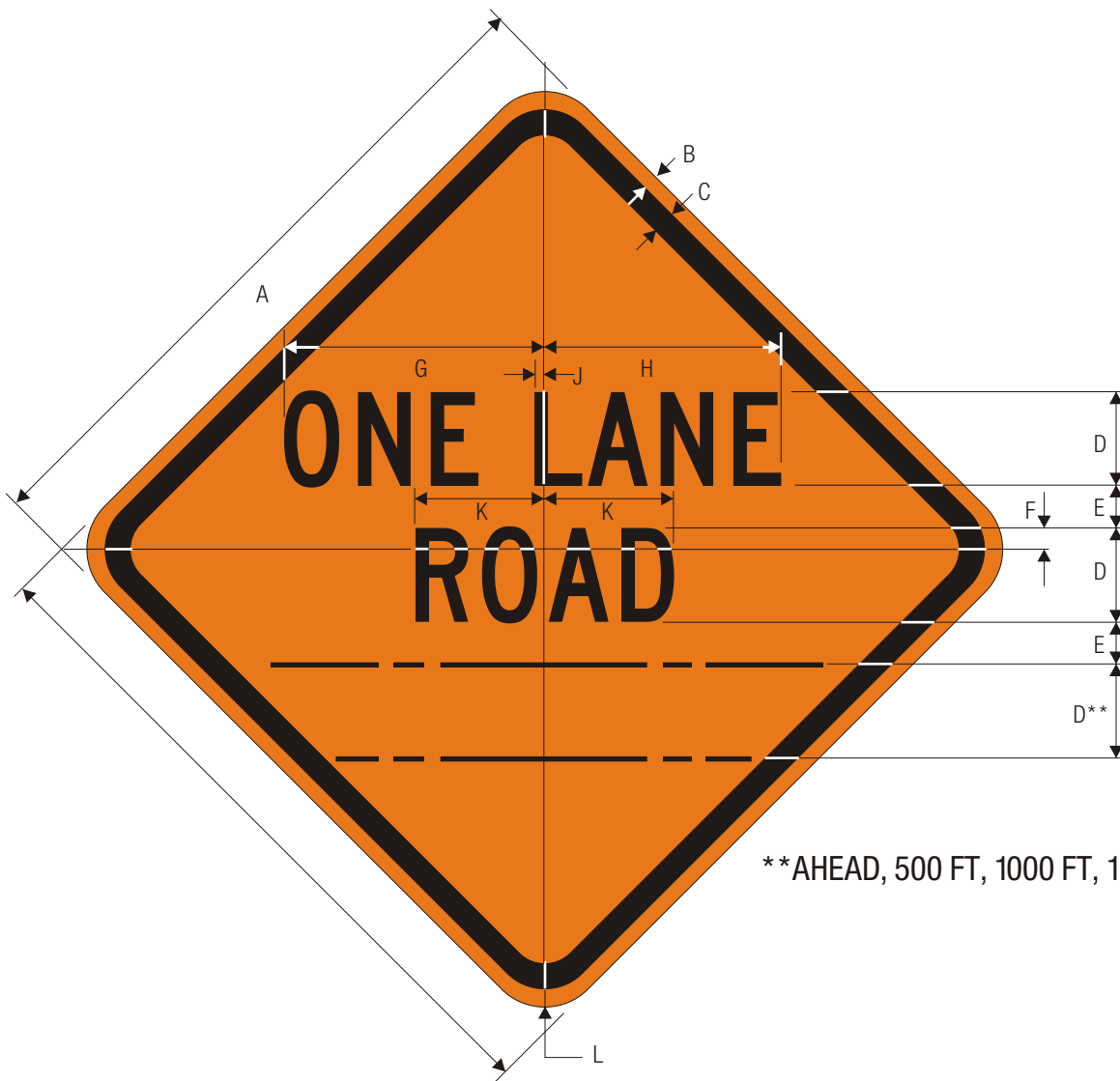

**AHEAD, 500 FT, 1000 FT, 1/2 MILE

W20-4
ONE LANE ROAD

	A	B	C	D	E	F	G	H	J	K	L
C	36	.625	.875	5 C	2.25	1.25	12.125	12.625	.375	7	2.25
	48	.75	1.25	7 C	3.125	1.75	18.5	17.75	.5	9.688	3

TTC SIGN COLORS:
 LEGEND — BLACK
 BACKGROUND— ORANGE (RETROREFLECTIVE)

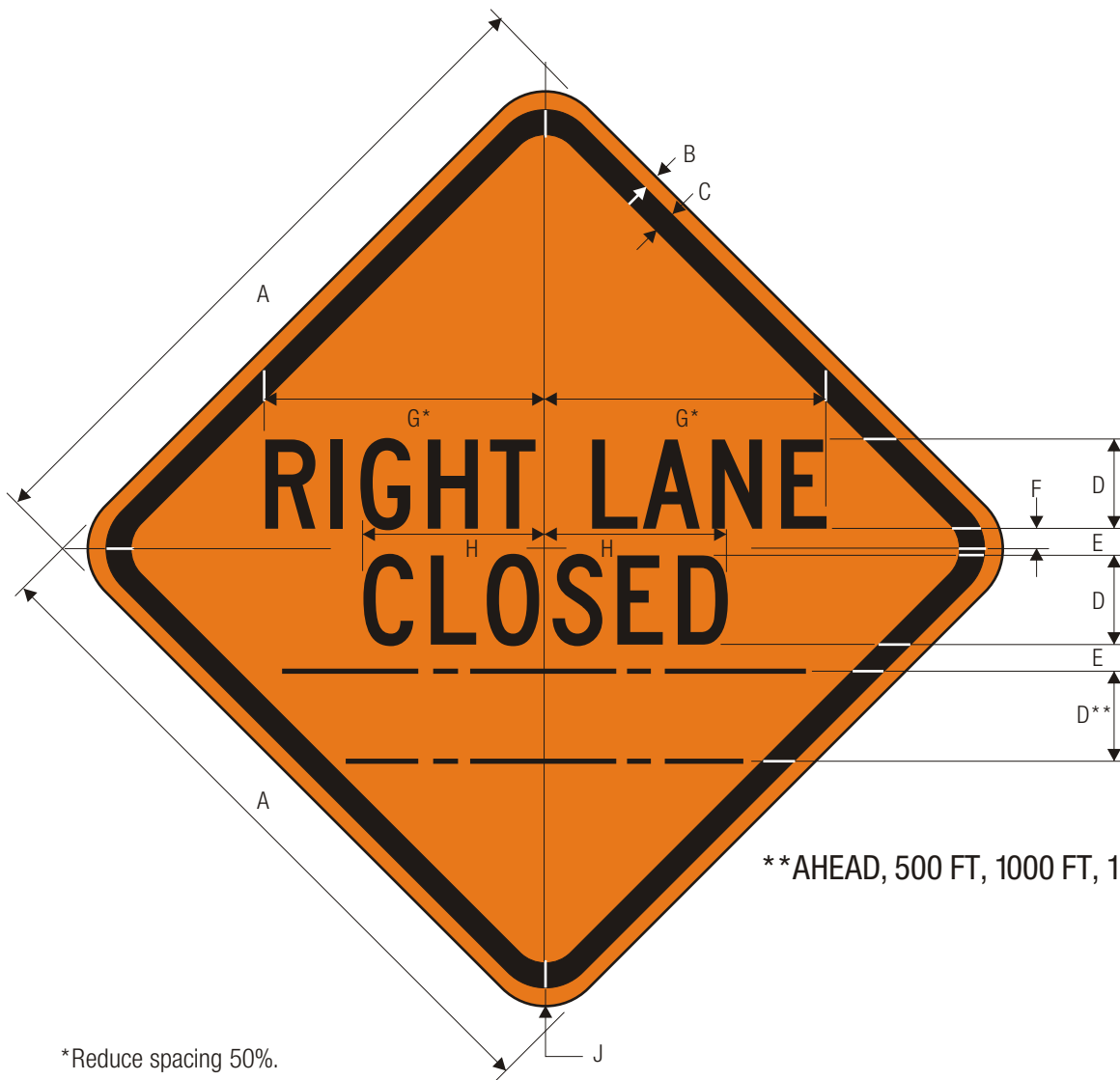

**AHEAD, 500 FT, 1000 FT, 1/2 MILE

*Reduce spacing 50%.

W20-5

RIGHT (CENTER) (LEFT) LANE CLOSED



C

A	B	C	D	E	F	G	H	J	K	L	M
36	.625	.875	5 C	2.75	.375	15.75	10.25	2.25	14.5	16.25	15.75
48	.75	1.25	6 C	3.375	.5	19	12.313	3	17.438	20.375	19.375

TTC SIGN COLORS:

LEGEND — BLACK

BACKGROUND— ORANGE (RETROREFLECTIVE)

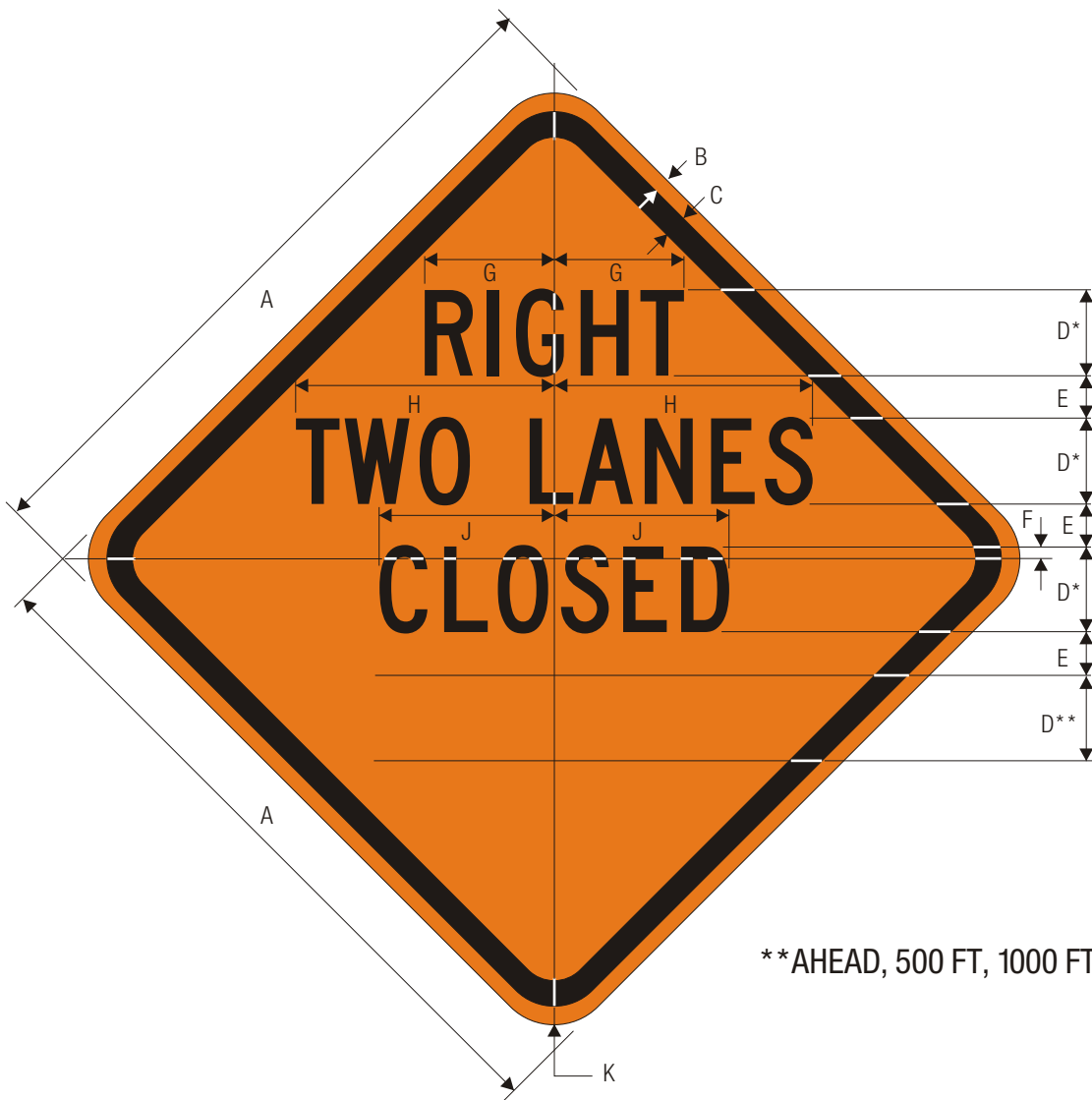

**AHEAD, 500 FT, 1000 FT, 1/2 MILE

W20-5a

RIGHT TWO LANES CLOSED

*Series 2000 Standard Alphabets.

C

A	B	C	D	E	F	G	H	J	K
30	.5	.75	4 C	1.521	.560	6.064	12.069	8.166	1.875
36	.625	.875	5 C	2	.720	7.565	15.091	10.207	2.25
48	.75	1.25	6 C	3	1	9.086	18.113	12.249	3

TTC SIGN COLORS:

LEGEND — BLACK

BACKGROUND— ORANGE (RETROREFLECTIVE)

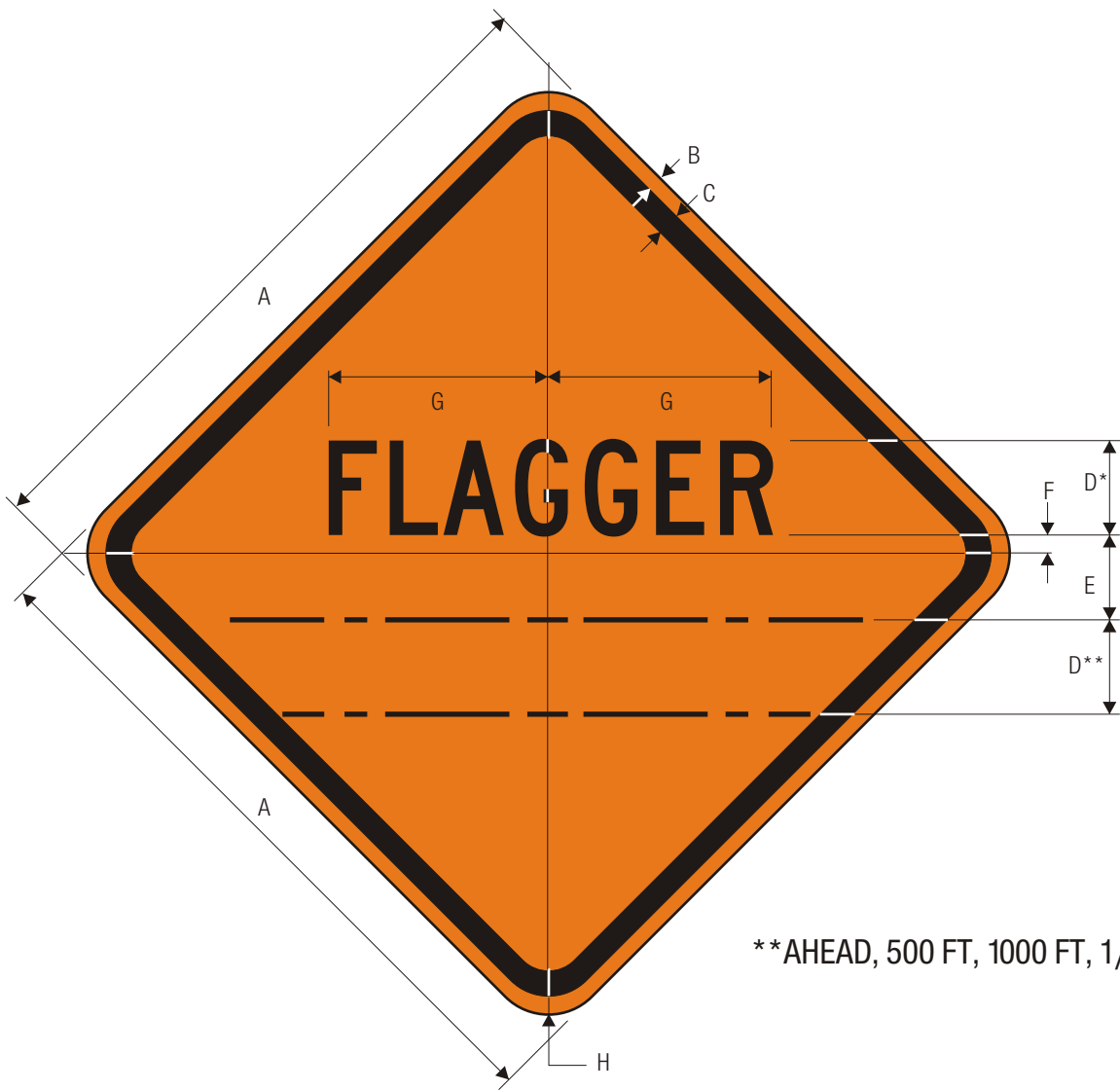

**AHEAD, 500 FT, 1000 FT, 1/2 MILE

W20-7
FLAGGER

*Series 2000 Standard Alphabets.

	A	B	C	D	E	F	G	H
C	36	.625	.875	5 C	4.483	1	11.748	2.25
	48	.75	1.25	7 C	6.244	2.481	16.452	3

TTC SIGN COLORS:
LEGEND — BLACK
BACKGROUND— ORANGE (RETROREFLECTIVE)

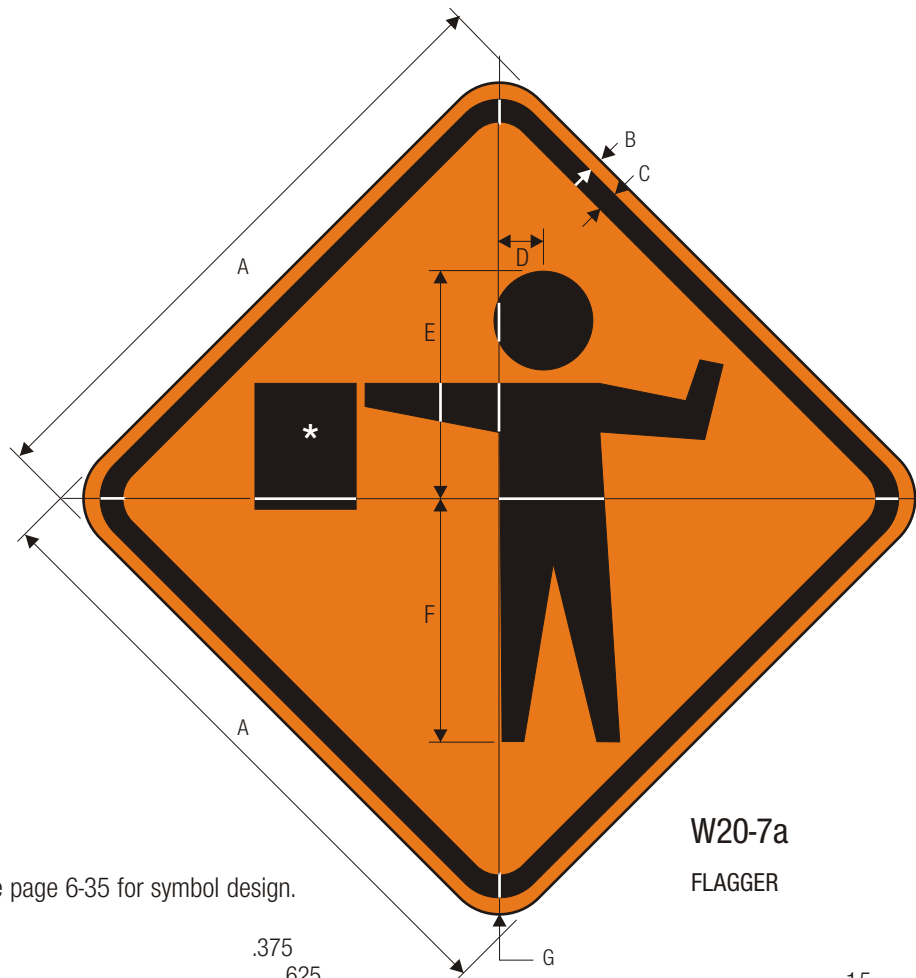

W20-7a
FLAGGER

*See page 6-35 for symbol design.

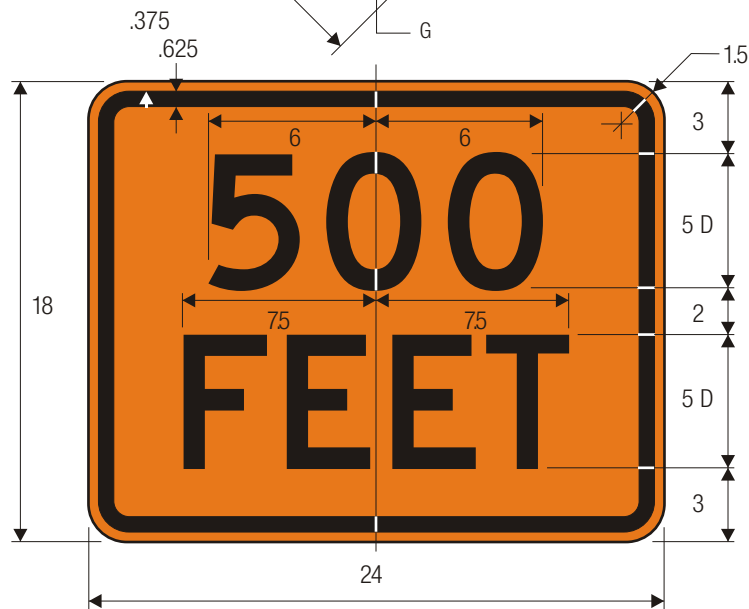

W16-2
DISTANCE (2 LINE) (ENGLISH)

A	B	C	D	E	F	G
24	.375	.625	1.75	9	9.688	1.5
30	.5	.75	2.25	11.25	12.125	1.875
36	.625	.875	2.75	13.5	14.625	2.25
48	.75	1.25	3.75	18	19.5	3

TTC SIGN COLORS:

LEGEND — BLACK

BACKGROUND— ORANGE (RETROREFLECTIVE)



W21-1
WORKERS

*Series 2000 Standard Alphabets.

	A	B	C	D	E	F	G
	24	.375	.625	2	4 D	11.788	1.5
	30	.5	.75	2.5	5 D	14.731	1.875
C	36	.625	.875	3	6 D	17.693	2.25
	48	.75	1.25	4	8 D	23.577	3

TTC SIGN COLORS:
 LEGEND — BLACK
 BACKGROUND— ORANGE (RETROREFLECTIVE)



W21-1a

WORKERS

*See page 6-59 for symbol design.

	A	B	C	D	E	F	G
	30	.5	.75	1.875	14	10	1.875
C	36	.625	.875	2.25	16.875	12	2.25
	48	.75	1.25	3	22.375	16	3

TTC SIGN COLORS:

SYMBOL — BLACK

BACKGROUND— ORANGE (RETROREFLECTIVE)

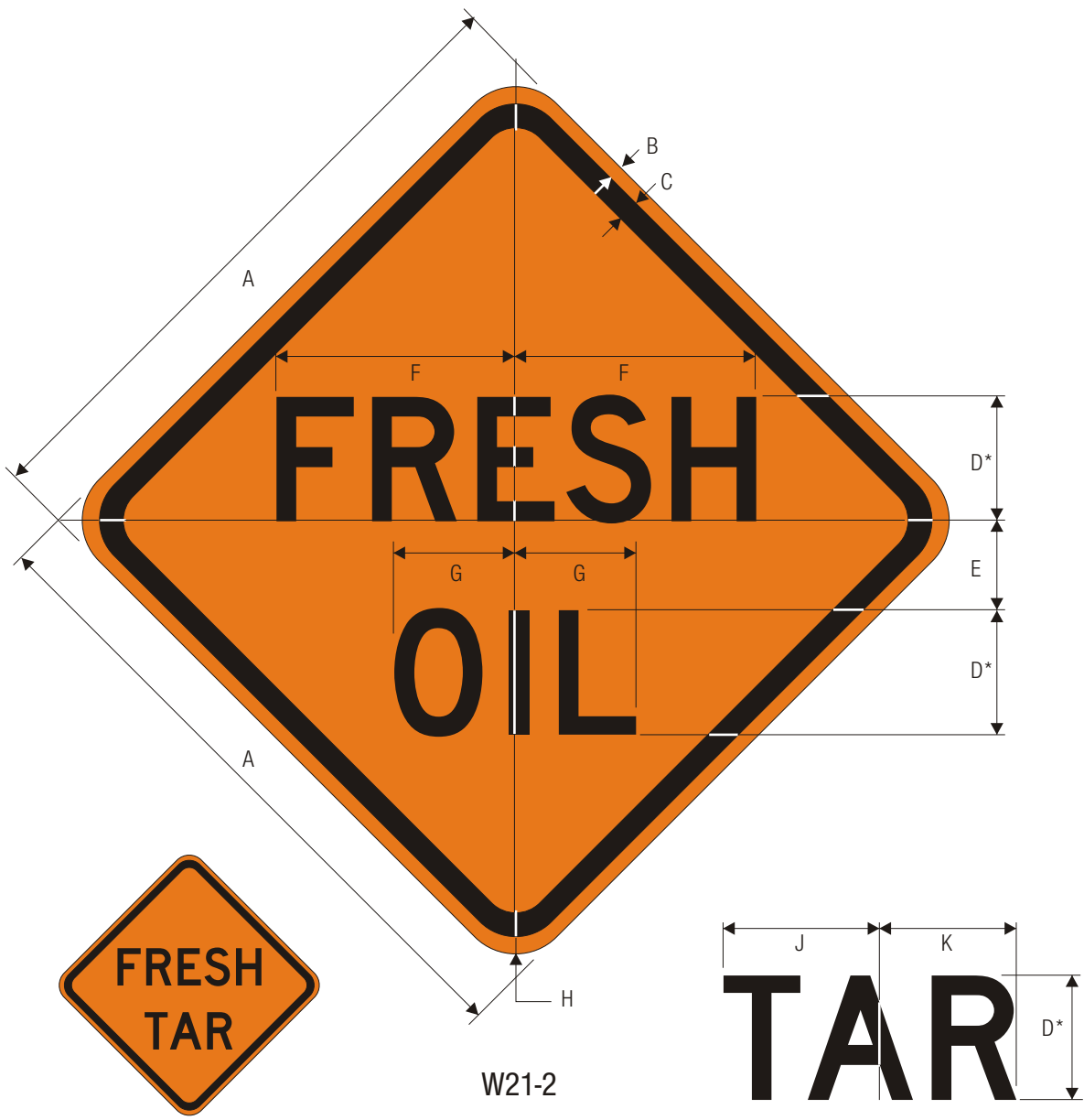

W21-2

FRESH OIL (TAR)

*Series 2000 Standard Alphabets.

	A	B	C	D	E	F	G	H	J	K
	24	.375	.625	5 D	3	9.647	4.863	1.5	6.204	5.564
C	30	.5	.75	6 D	4	11.568	5.824	1.875	7.285	6.845
	36	.625	.875	7 D	5	13.490	6.805	2.25	8.326	8.166
	48	.75	1.25	8 D	6	15.431	7.785	3	10.127	8.726

TTC SIGN COLORS:
 LEGEND — BLACK
 BACKGROUND— ORANGE (RETROREFLECTIVE)

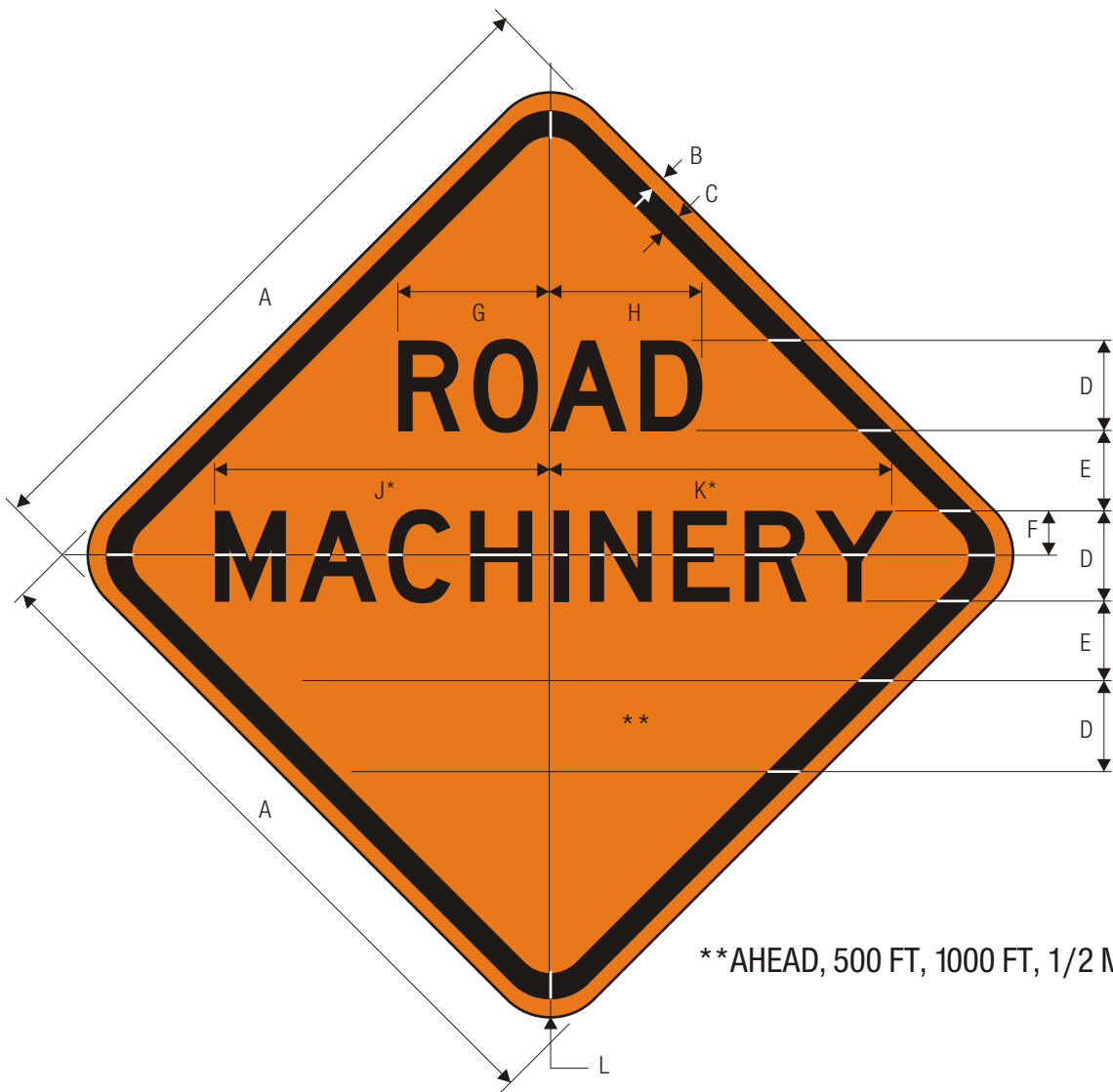

**AHEAD, 500 FT, 1000 FT, 1/2 MILE

W21-3

ROAD MACHINERY

Use Series 2000 Alphabets for 24" size.

*Reduce spacing 40%.

C

A	B	C	D	E	F	G	H	J	K	L
24	.375	.625	3 D	2.5	1.5	5	5	10.875	11.463	1.5
30	.5	.75	4 D	3.5	2	6.75	7	13.5	14	1.875
36	.625	.875	5 D	4	2.5	8.375	8.875	16.813	17.563	2.25
48	.75	1.25	7 D	5	3.5	11.688	12.438	23.625	24.625	3

TTC SIGN COLORS:

LEGEND — BLACK

BACKGROUND— ORANGE (RETROREFLECTIVE)

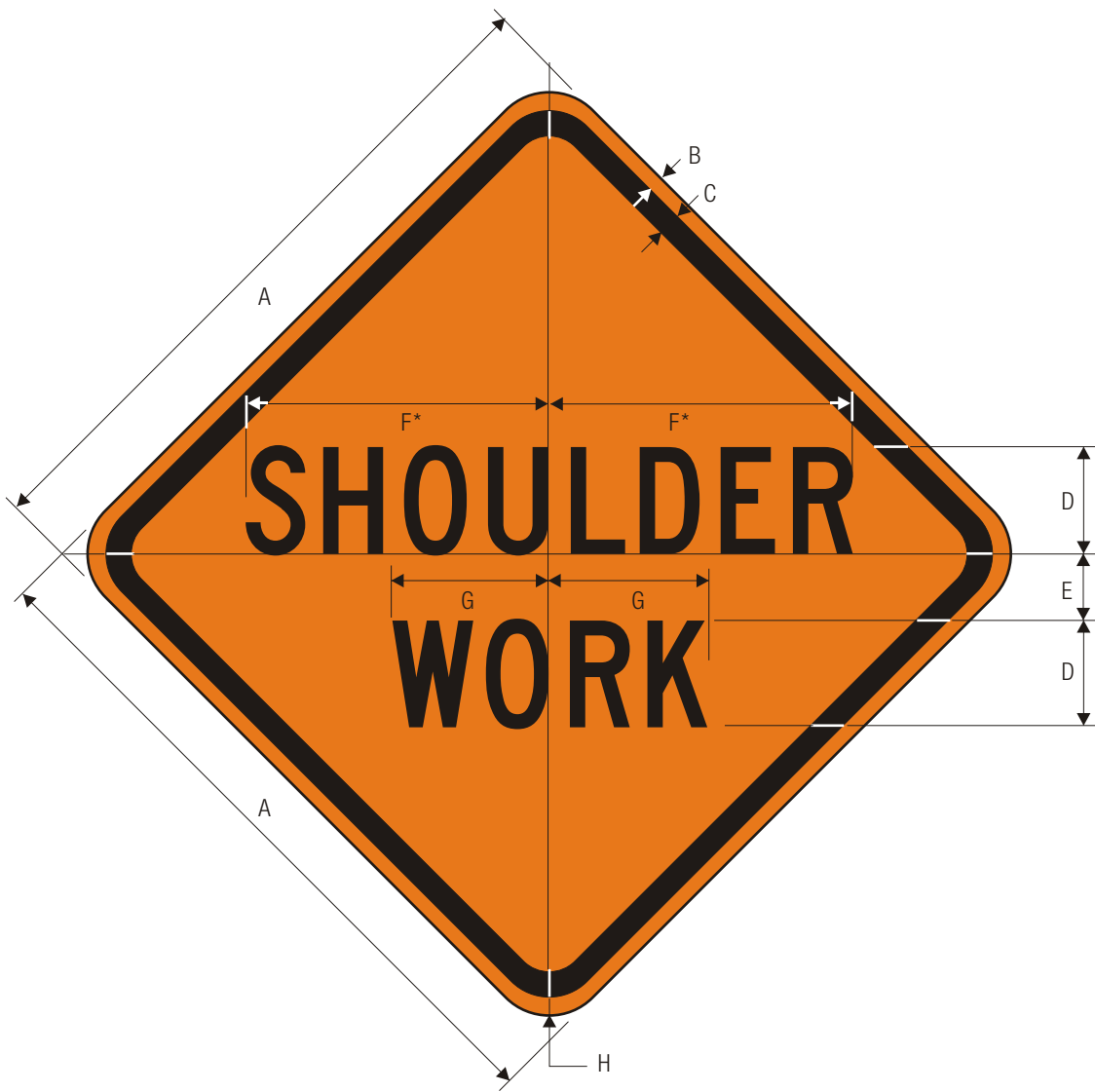

W21-5

SHOULDER WORK

*Reduce spacing 25%.
Use Series 2000 Alphabets for 48" size.

	A	B	C	D	E	F	G	H
	24	.375	.625	4 C	2.5	10.688	6	1.5
C	30	.5	.75	5 C	3	13.375	7.5	1.875
	36	.625	.875	6 C	3.5	16.063	9	2.25
	48	.75	1.25	7 C	5	19.897	10.323	3

TTC SIGN COLORS:

LEGEND — BLACK

BACKGROUND— ORANGE (RETROREFLECTIVE)

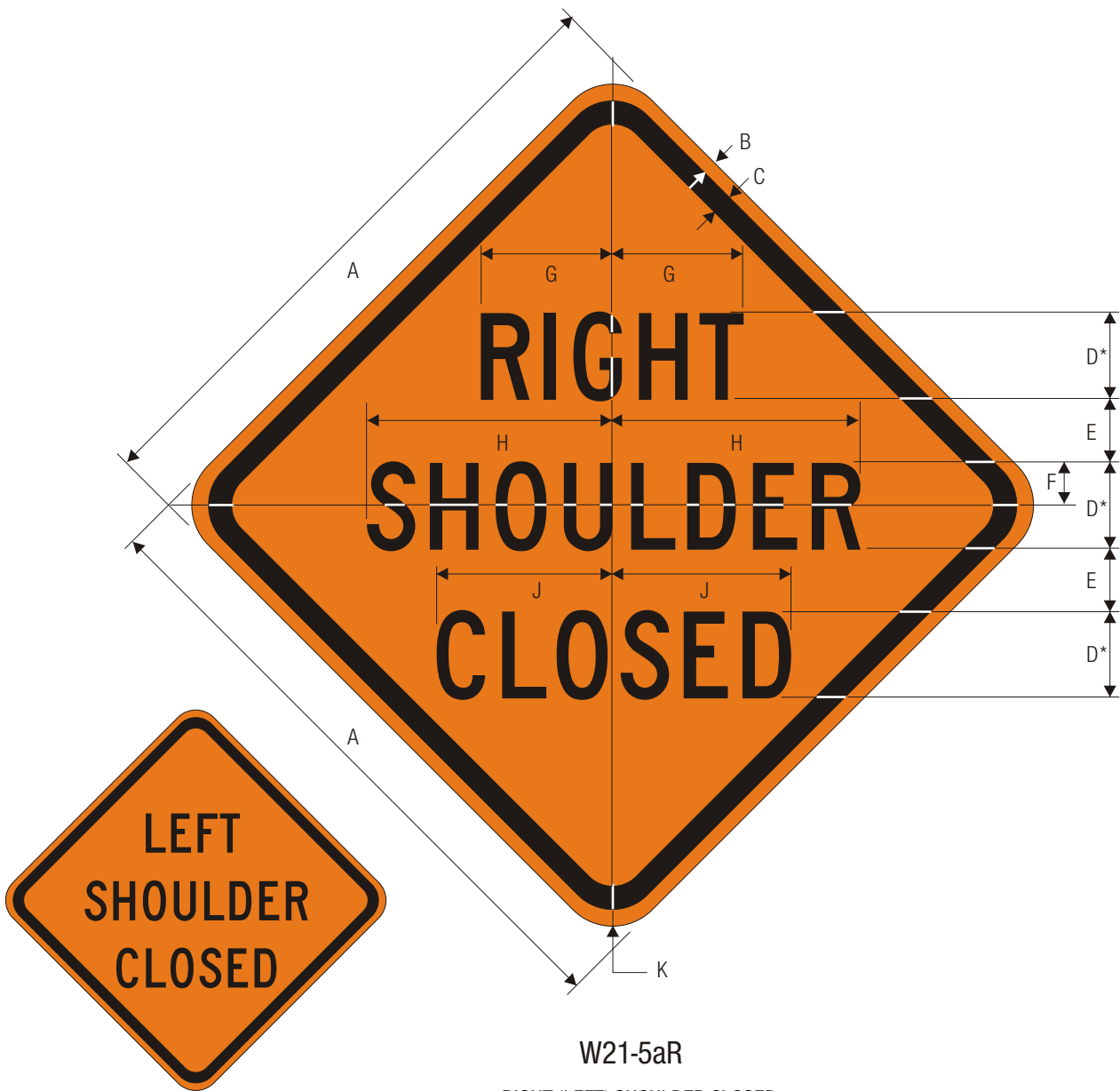

W21-5aL

W21-5aR
RIGHT (LEFT) SHOULDER CLOSED

*Series 2000 Standard Alphabets.

	A	B	C	D	E	F	G	H	J	K
	30	.5	.75	4 C	2.75	2	6.025	11.368	8.163	1.875
C	36	.625	.875	5 C	3.682	2.481	7.565	14.230	10.207	2.25
	48	.75	1.25	7 C	4.803	3.482	10.608	19.194	13.790	3
	60	.75	1.25	8 C	5.484	4	12.109	22.757	16.332	3

TTC SIGN COLORS:

LEGEND — BLACK

BACKGROUND— ORANGE (RETROREFLECTIVE)

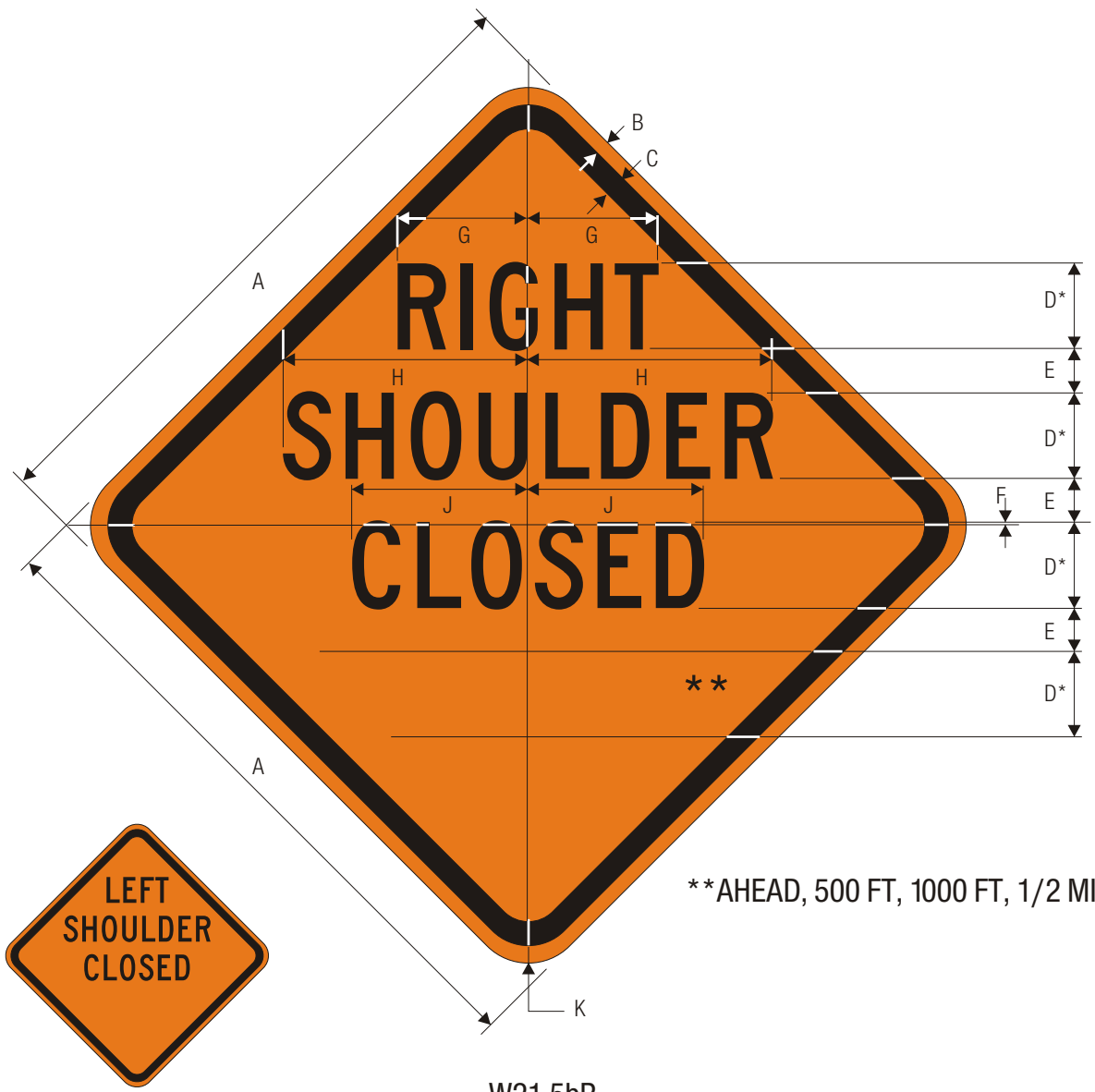

W21-5bL

W21-5bR
RIGHT (LEFT) SHOULDER CLOSED

** AHEAD, 500 FT, 1000 FT, 1/2 MILE

*Series 2000 Standard Alphabets.

	A	B	C	D	E	F	G	H	J	K
	30	.5	.75	4 C	2	.160	6.064	11.368	8.166	1.875
C	36	.625	.875	5 C	2.401	.200	7.565	14.230	10.207	2.25
	48	.75	1.25	6 C	3	.240	9.086	17.072	12.249	3
	60	.75	1.25	8 C	4	.320	12.109	22.757	16.332	3

TTC SIGN COLORS:
 LEGEND — BLACK
 BACKGROUND— ORANGE (RETROREFLECTIVE)

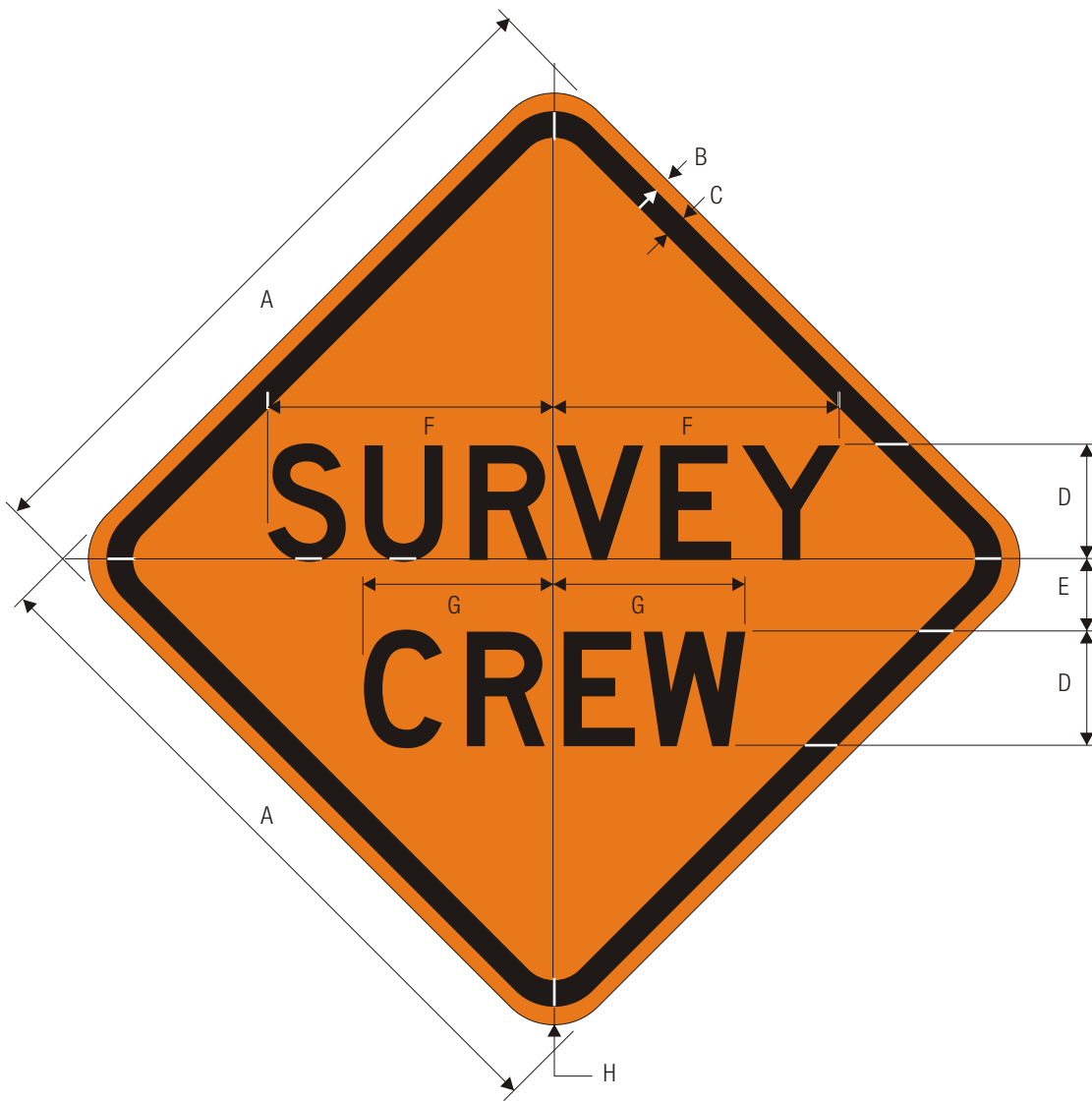

W21-6

SURVEY CREW

	A	B	C	D	E	F	G	H
	24	.375	.625	4 D	2.5	10.375	6.75	1.5
C	30	.5	.75	5 D	3	13	8.875	1.875
	36	.625	.875	6 D	3.5	15.563	10.125	2.25
	48	.75	1.25	8 D	4.75	19.995	13.330	3

TTC SIGN COLORS:

LEGEND — BLACK

BACKGROUND— ORANGE (RETROREFLECTIVE)

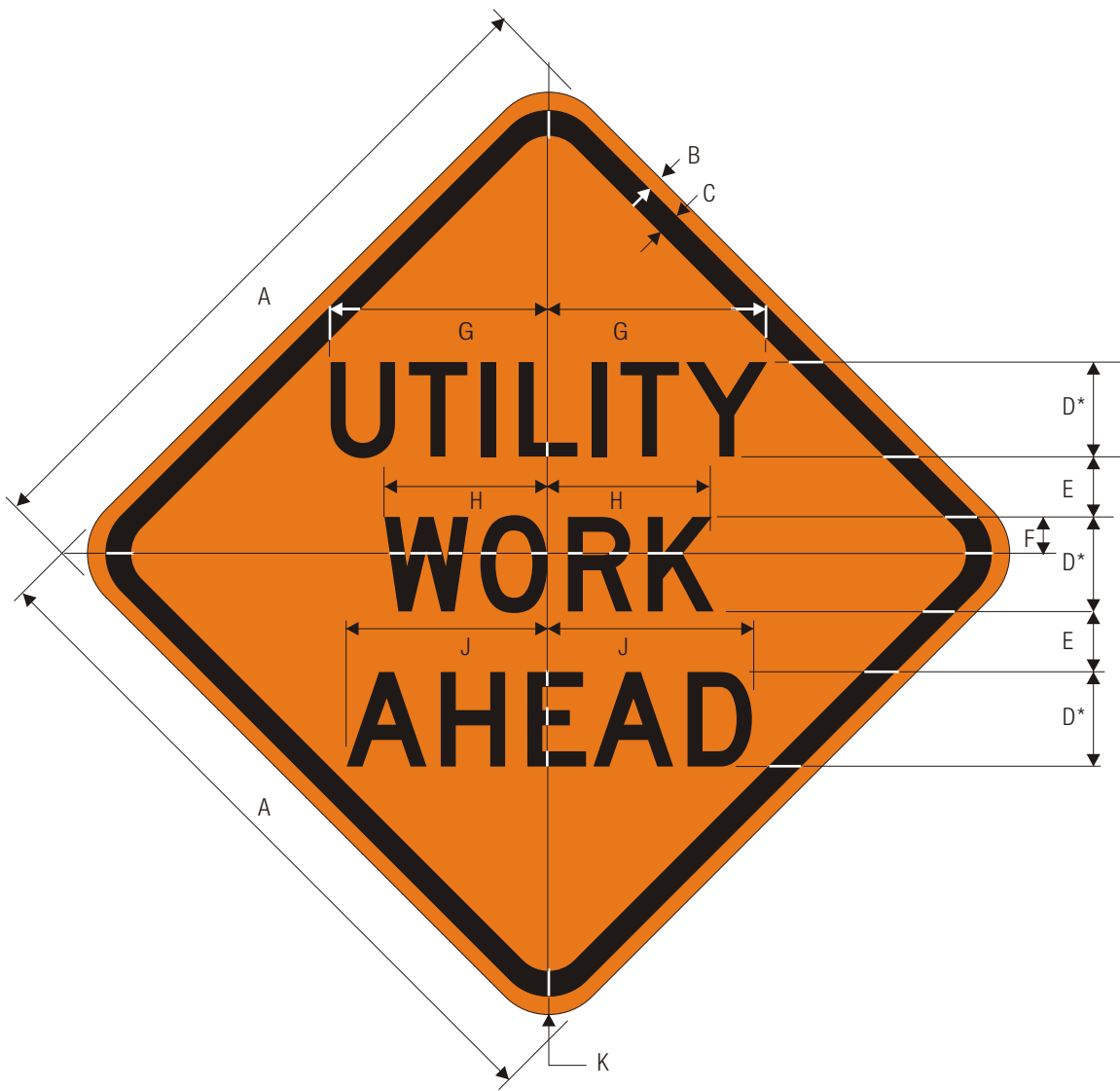

W21-7
UTILITY WORK AHEAD

*Series 2000 Standard Alphabets.

	A	B	C	D	E	F	G	H	J	K
	30	.5	.75	4 D	2.802	1.601	9.227	6.965	8.586	1.875
C	36	.625	.875	5 D	3.202	2	11.548	8.706	10.728	2.25
	48	.75	1.25	7 D	3.602	2.281	16.172	9.887	14.611	3

TTC SIGN COLORS:
 LEGEND — BLACK
 BACKGROUND— ORANGE (RETROREFLECTIVE)

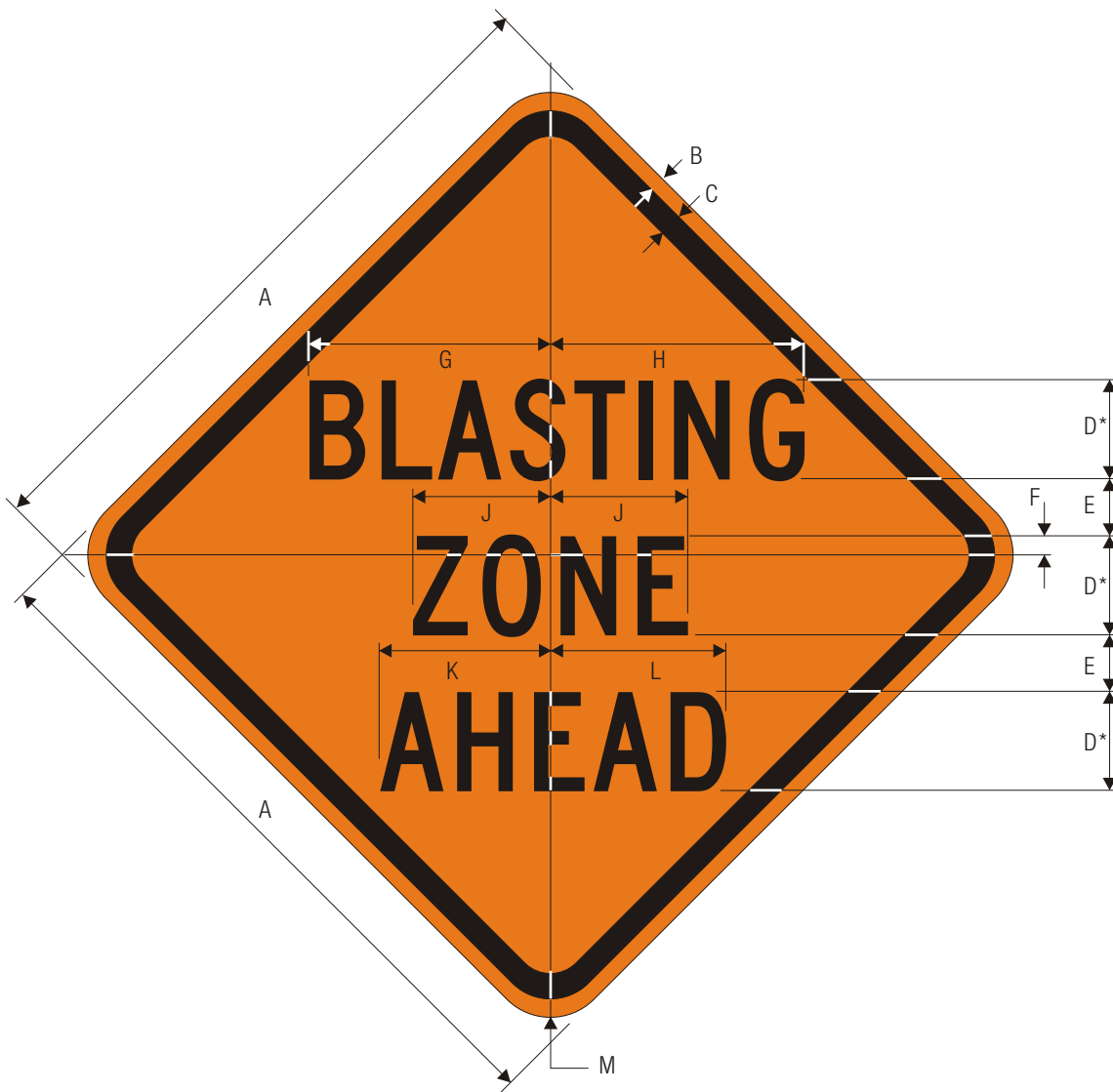

W22-1

BLASTING ZONE AHEAD

*Series 2000 Standard Alphabets.

A	B	C	D	E	F	G	H	J	K	L	M
36	.625	.875	5 C	3	.960	12.129	12.809	6.925	8.446	9	2.25
C 48	.75	1.25	7 C	4	1.481	17	17.933	9.707	11.768	12.649	3

TTC SIGN COLORS:

LEGEND — BLACK

BACKGROUND— ORANGE (RETROREFLECTIVE)



W22-2

TURN OFF 2-WAY RADIO AND CELL PHONE

*Series 2000 Standard Alphabets.
 **Reduce spacing to fit.

	A	B	C	D	E	F	G	H	J	K	L	M
C	42	36	.75	1.25	5	7 C	4	4 C	1.5	18.714	13.910	4.223

N	P
13.486	3

TTC SIGN COLORS:
 LEGEND — BLACK
 BACKGROUND— ORANGE (RETROREFLECTIVE)



W22-3
END BLASTING ZONE

*Reduce spacing 40%.

	A	B	C	D	E	F	G	H	J	K	L
C	42	36	.625	.875	4.5	7 C	3	6.563	7.25	2.25	17.5
	M	N									
	18	9.688									

TTC SIGN COLORS:
 LEGEND — BLACK
 BACKGROUND— ORANGE (RETROREFLECTIVE)

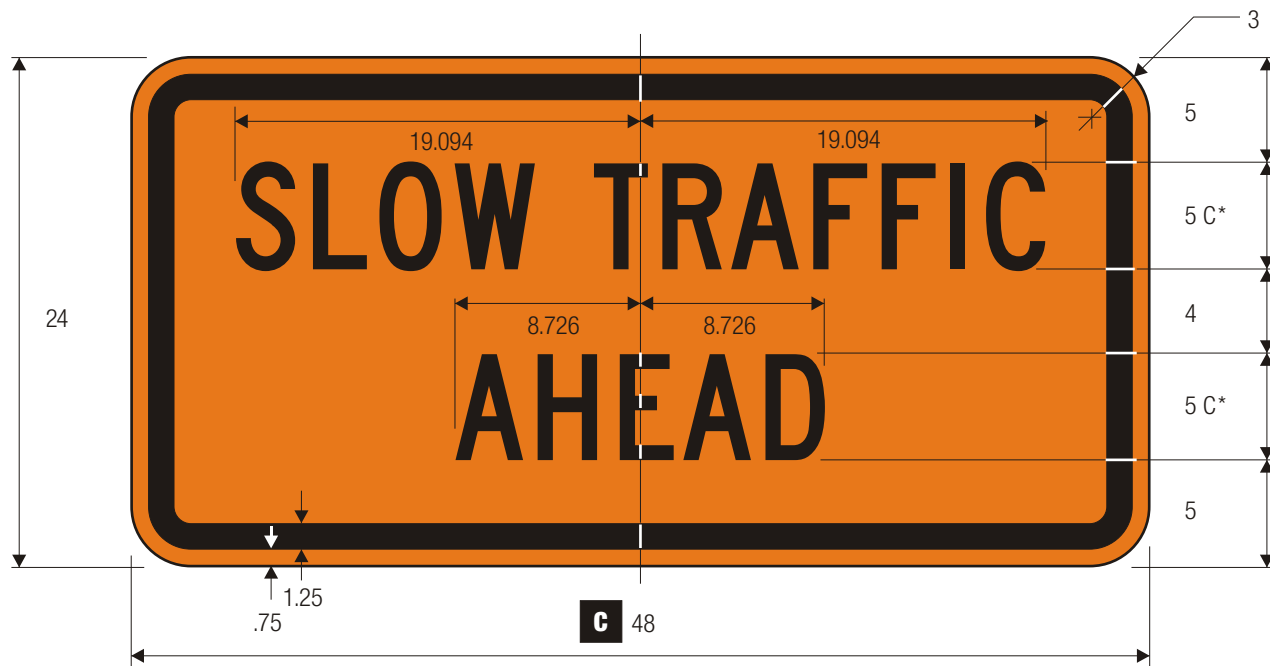

W23-1
SLOW TRAFFIC AHEAD

*Series 2000 Standard Alphabets.

TTC SIGN COLORS:
 LEGEND — BLACK
 BACKGROUND— ORANGE (RETROREFLECTIVE)

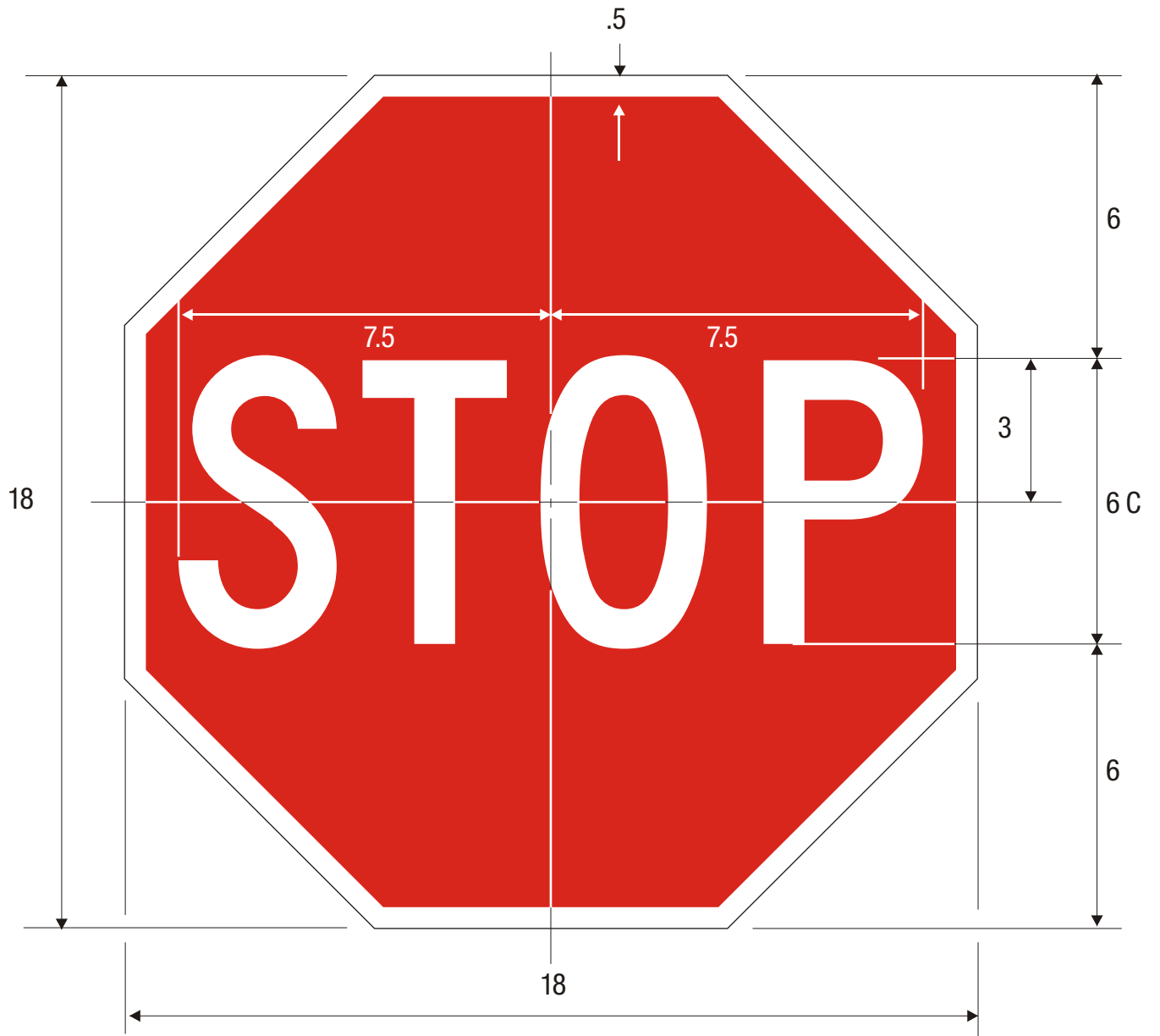

STOP - SLOW PADDLE

COLORS: LEGEND — WHITE (RETROREFLECTIVE)
 BACKGROUND — RED (RETROREFLECTIVE)

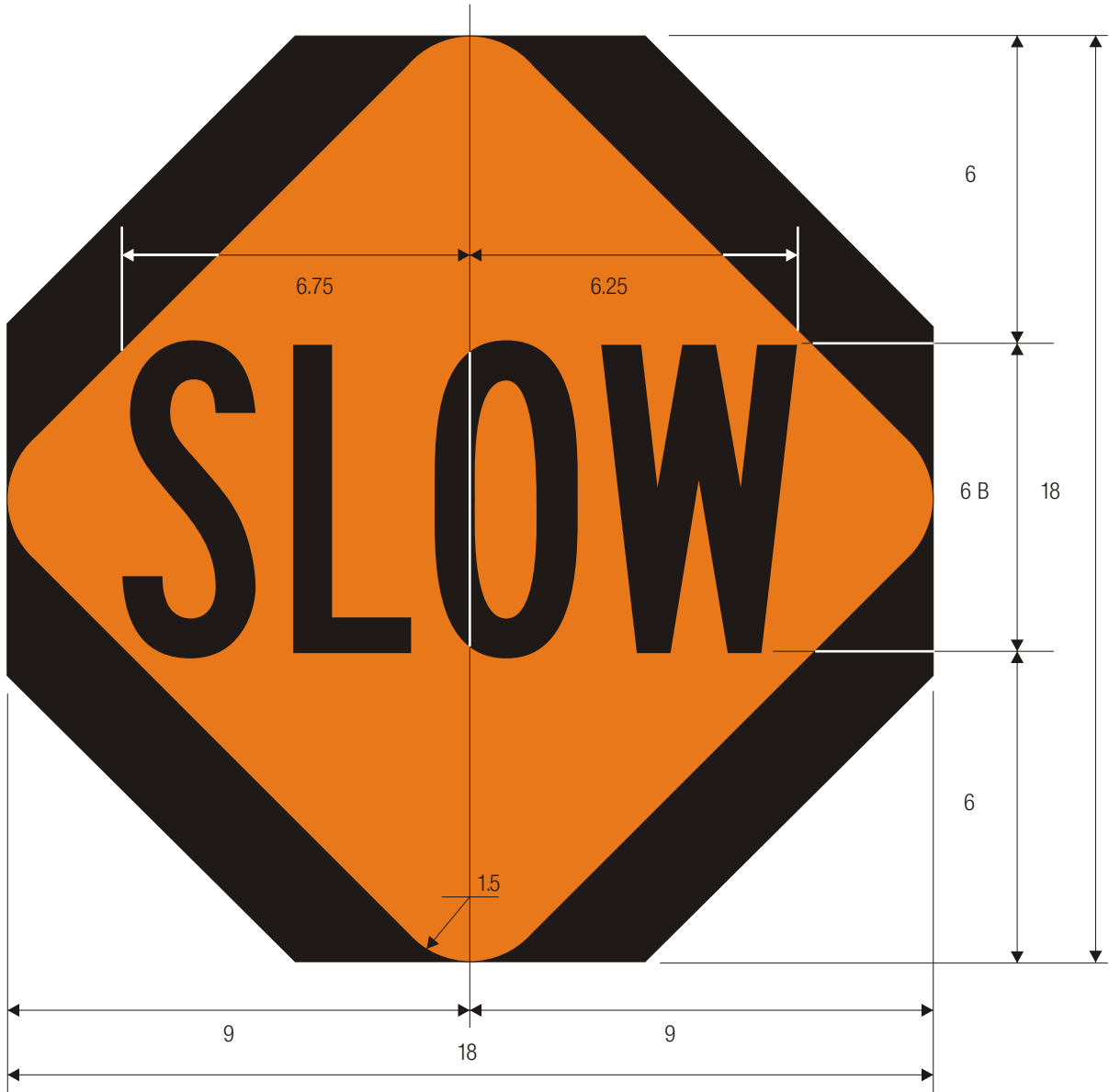

STOP - SLOW PADDLE

COLORS: LEGEND – BLACK
 BACKGROUND – ORANGE (RETROREFLECTIVE)
 AREA OUTSIDE DIAMOND – BLACK

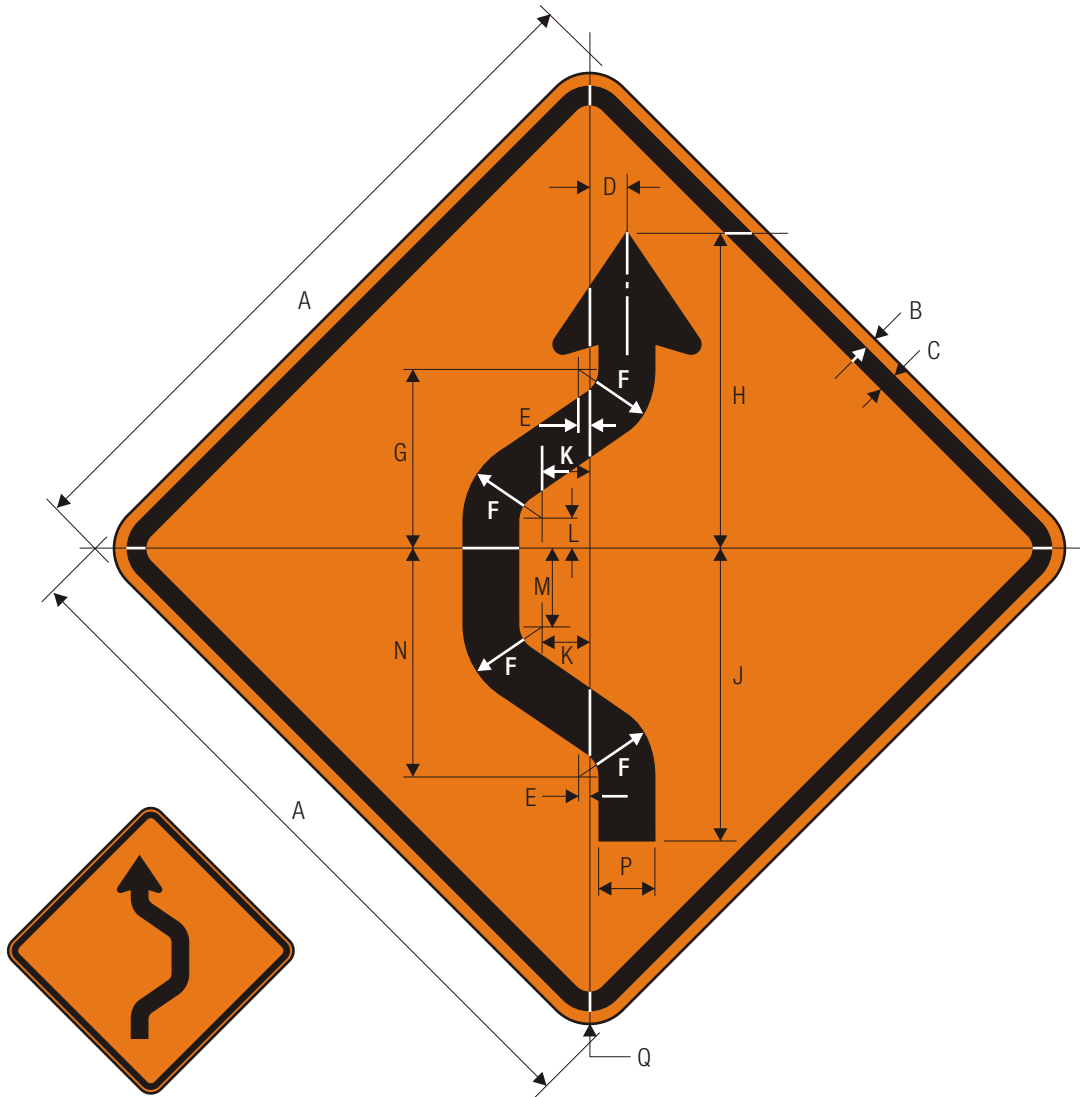

W24-1R

DOUBLE REVERSE CURVE (1 LANE)

W24-1L

DOUBLE REVERSE CURVE (1 LANE)

*See page 6-2 for symbol design.

	A	B	C	D	E	F	G	H	J	K	L	M
	30	.5	.75	1.601	.280	3.082	7.405	13.570	12.569	2.361	1.481	3.522
C	36	.625	.875	1.921	.336	3.698	8.886	16.284	15.082	2.833	1.777	4.226
	48	.75	1.25	2.561	.448	4.931	11.848	21.712	20.110	3.777	2.369	5.635

	N	P	Q
	9.487	2.401	1.875
	11.384	2.881	2.25
	15.179	3.841	3

TTC SIGN COLORS:
 SYMBOL — BLACK
 BACKGROUND— ORANGE (RETROREFLECTIVE)

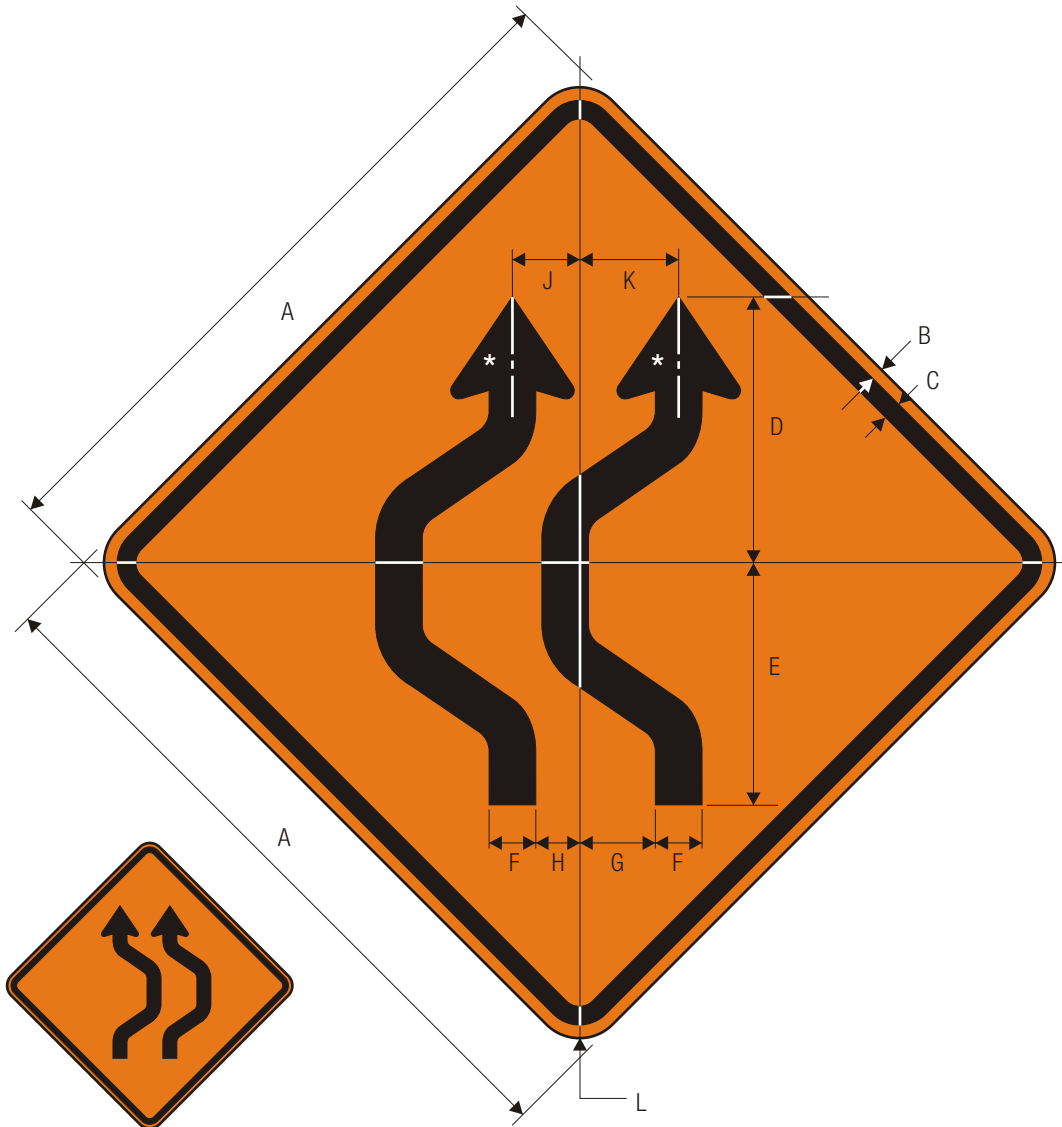

W24-1aR

W24-1aL

DOUBLE REVERSE CURVE (2 LANES)

DOUBLE REVERSE CURVE (2 LANES)

*Reduce arrow from W24-1 15%.

	A	B	C	D	E	F	G	H	J	K	L
	30	.5	.75	11.534	10.683	2	3.242	1.881	2.901	4.261	1.875
C	36	.625	.875	13.801	12.819	2.4	3.882	2.241	3.465	5.105	2.25
	48	.75	1.25	18.455	17.093	3.25	5.202	3.042	4.677	6.834	3

TTC SIGN COLORS:

SYMBOL — BLACK

BACKGROUND— ORANGE (RETROREFLECTIVE)

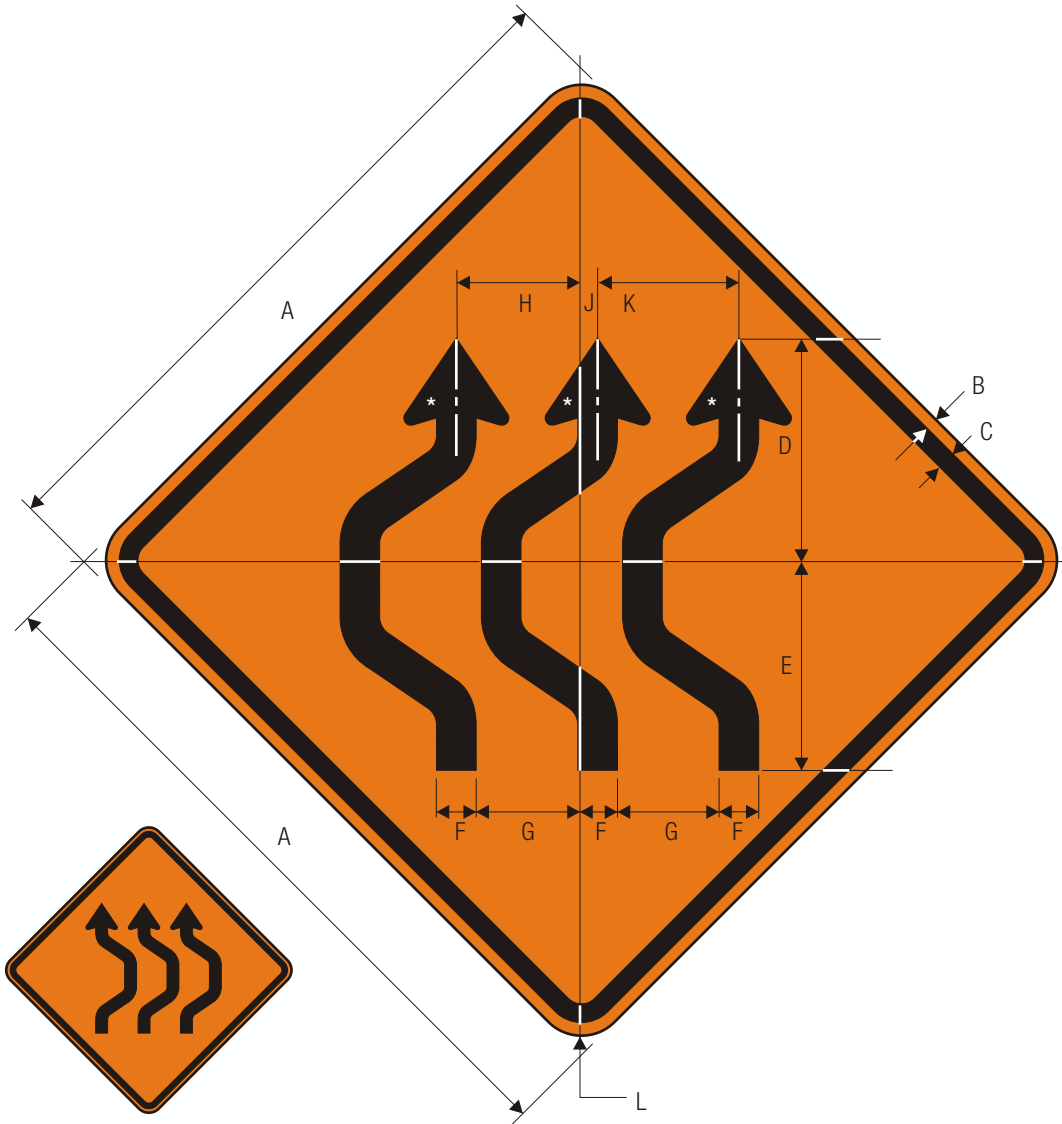

W24-1bR

DOUBLE REVERSE CURVE (3 LANES)

W24-1bL

DOUBLE REVERSE CURVE (3 LANES)

*Reduce arrow from W24-1 30%.

	A	B	C	D	E	F	G	H	J	K	L
	30	.5	.75	9.487	8.806	1.681	4.723	5.564	.840	6.404	1.875
C	36	.625	.875	11.408	10.568	2	5.684	6.685	1	7.685	2.25
	48	.75	1.25	15.171	14.050	2.682	7.525	8.846	1.321	10.207	3

TTC SIGN COLORS:

SYMBOL — BLACK

BACKGROUND— ORANGE (RETROREFLECTIVE)

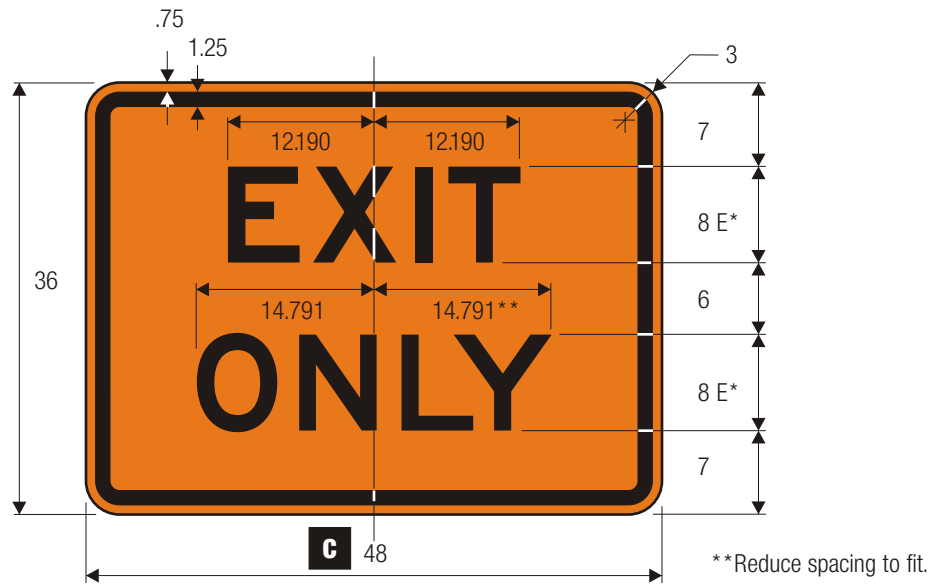

*Series 2000 Standard Alphabets.

E5-3 EXIT ONLY



E5-2 EXIT OPEN



E5-2a EXIT CLOSED

TTC SIGN COLORS:

LEGEND — BLACK

BACKGROUND— ORANGE (RETROREFLECTIVE)

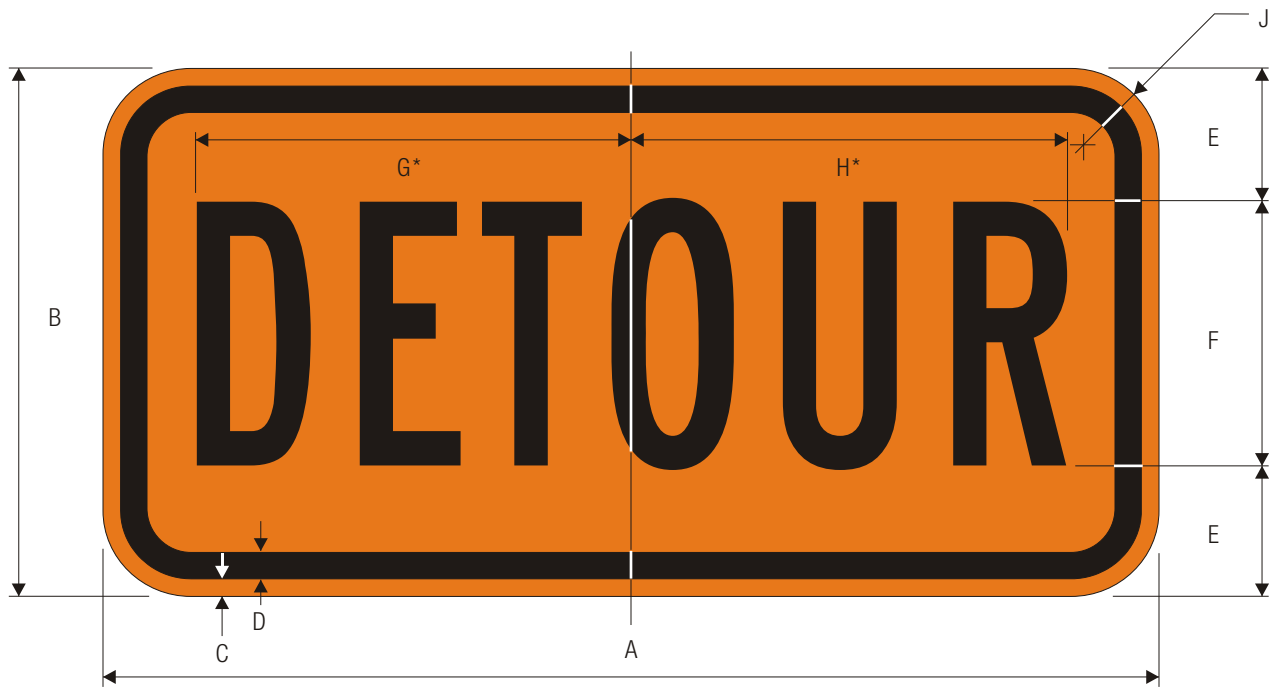

M4-8

DETOUR

*Reduce spacing 20%.

	A	B	C	D	E	F	G	H	J
G	24	12	.375	.625	3	6 B	9.188	9.563	1.5
	30	15	.375	.625	3.5	8 B	12.25	12.75	1.5

TTC SIGN COLORS:

LEGEND — BLACK

BACKGROUND— ORANGE (RETROREFLECTIVE)

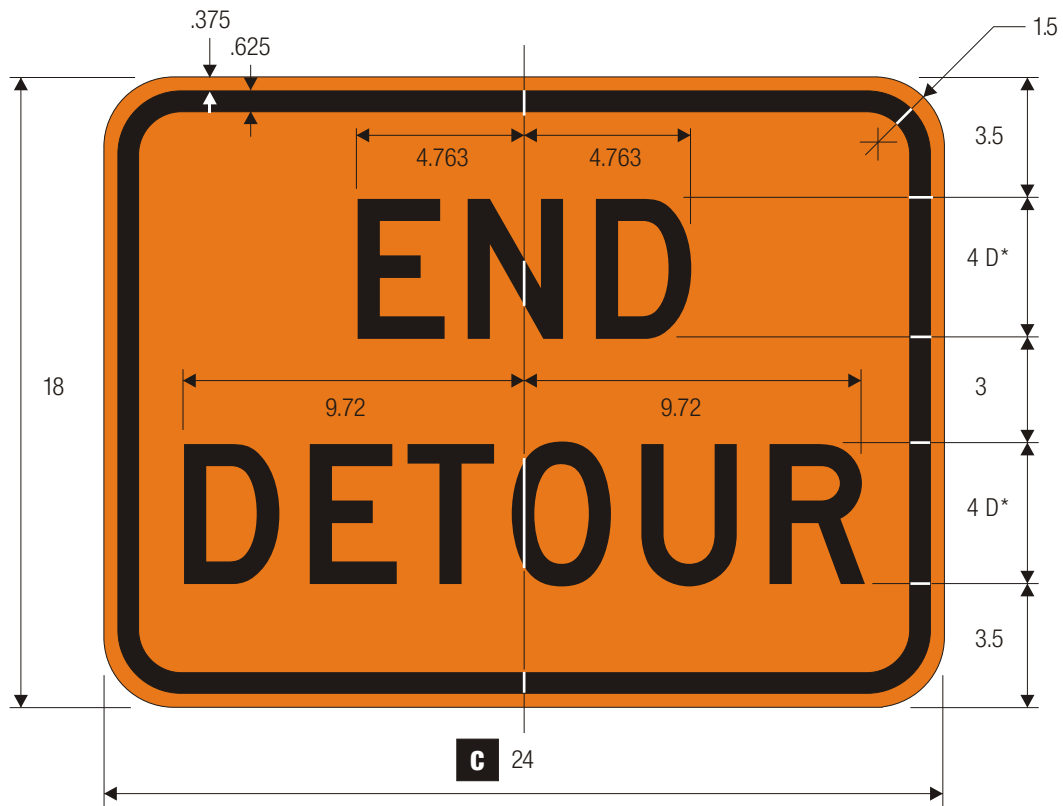

M4-8a

END DETOUR

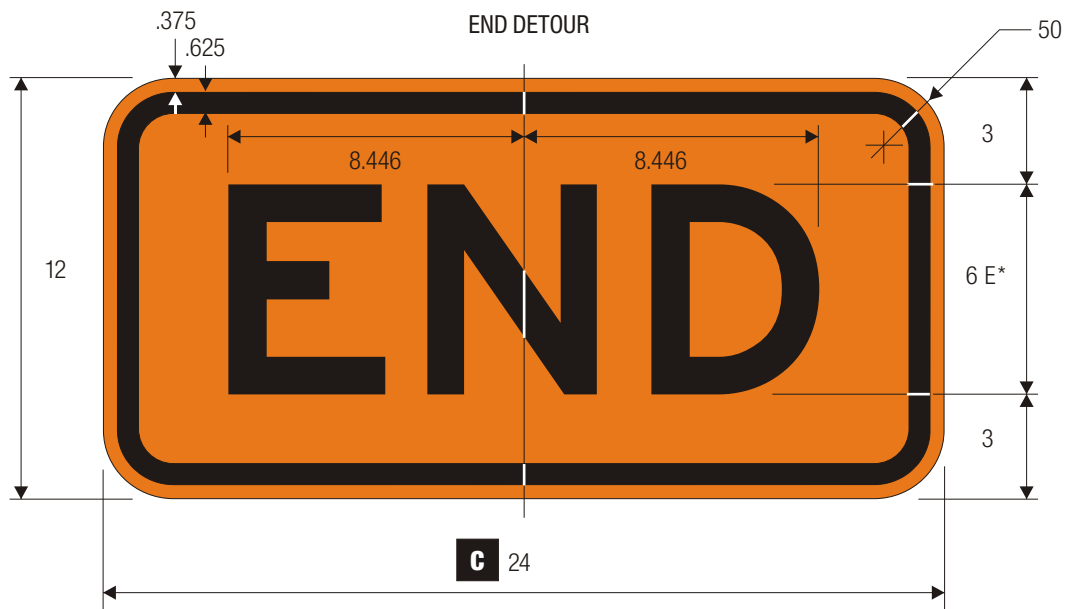

M4-8b

END

*Series 2000 Standard Alphabets.

TTC SIGN COLORS:
 LEGEND — BLACK
 BACKGROUND— ORANGE (RETROREFLECTIVE)

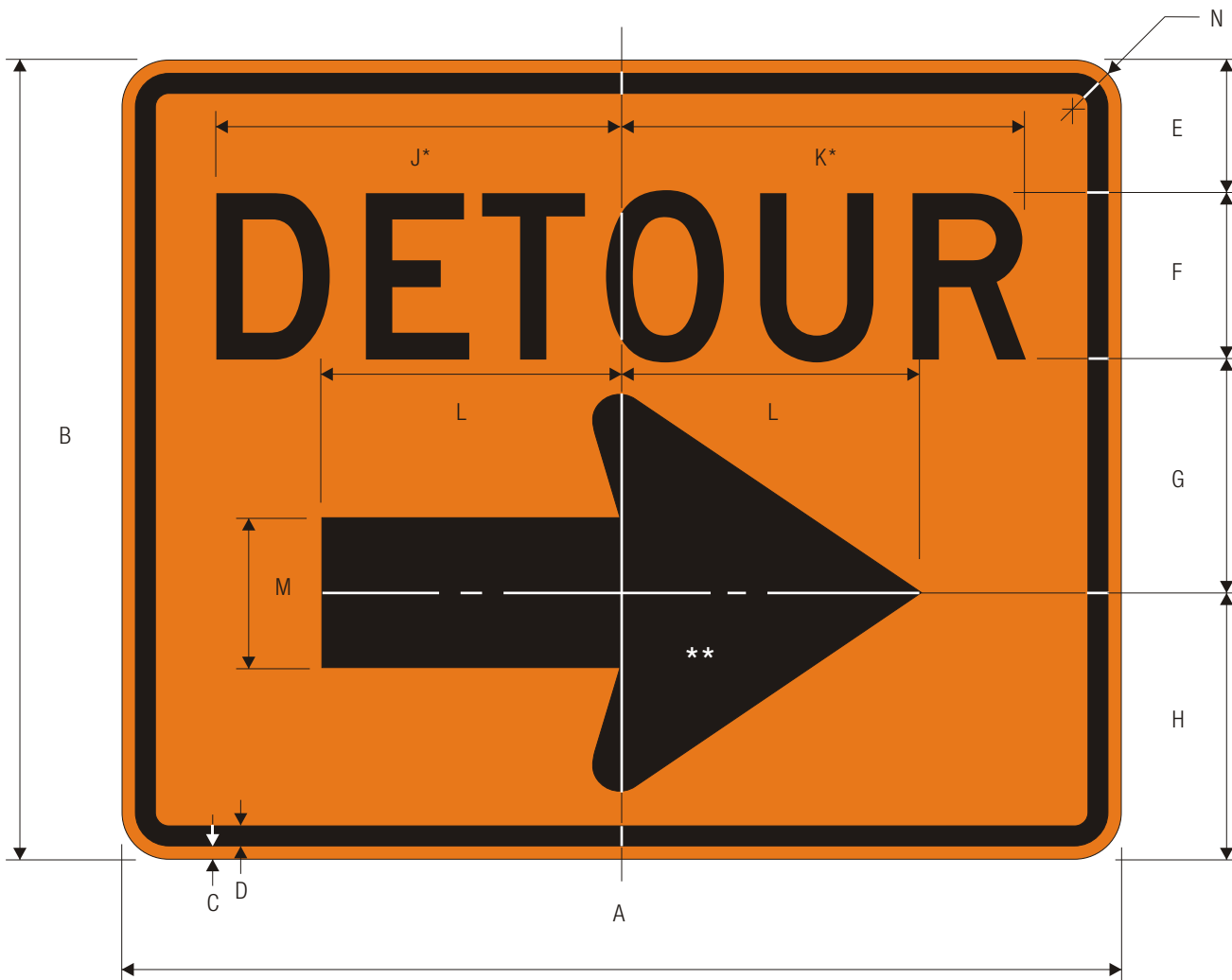

M4-9R

DETOUR



M4-9L

DETOUR

*Reduce spacing 40%.

**See page 6-2 for design details.

	A	B	C	D	E	F	G	H	J	K	L	M	N
C	30	24	.375	.625	4	5 D	7	8	11.5	12	9	4.5	1.5
	48	36	.625	.875	6	8 D	10	12	19.5	20.25	13.25	7	2.25
	60	48	.75	1.25	8	10 D	14	16	23	24	18	9	3

TTC SIGN COLORS:

LEGEND — BLACK

BACKGROUND— ORANGE (RETROREFLECTIVE)



M4-9a

BICYCLE PEDESTRIAN DETOUR

- *Series 2000 Standard Alphabets.
- **See page 6-10 for symbol design.
- ***See page 6-7 for symbol design.
- ****See page 6-2 for arrow design.

C	A	B	C	D	E	F	G	H	J	K	L	M
30	24	.5	.75	2	7.205	1	5 D	3.802	5	5.324	3.122	
48	36	.75	1.25	3	10.648	1.641	8 D	5.924	6.805	8.086	4.403	
60	48	.75	1.25	5.203	13.330	2.081	10 D	7.405	10	6.925	10.127	

N	P	Q	R	S	T
9	8.526	12.169	7	2	1.875
13.530	13.290	19.454	11.208	3.202	3
16.812	16.812	24.318	14	4	

TTC SIGN COLORS:
 LEGEND — BLACK
 BACKGROUND— ORANGE (RETROREFLECTIVE)



M4-9b
PEDESTRIAN DETOUR

*Series 2000 Standard Alphabets.
 **See page 6-10 for symbol design.
 Optically center symbol about centerline.
 ***See page 6-2 for design details.

C

A	B	C	D	E	F	G	H	J	K	L	M
30	24	.5	.75	2	7.205	1	5 D	3.802	5	12.169	7
48	36	.75	1.25	3	10.648	1.641	8 D	5.924	6.805	19.454	11.208
60	48	.75	1.25	5.203	13.330	2.081	10 D	7.405	10	24.318	14

N	P
2	1.875
3.202	3
4	3

TTC SIGN COLORS:
 LEGEND — BLACK
 BACKGROUND— ORANGE (RETROREFLECTIVE)



M4-9c
BICYCLE DETOUR

*Series 2000 Standard Alphabets.
**See page 6-7 for symbol design.
Optically center symbol about centerline.
***See page 6-2 for design details.

	A	B	C	D	E	F	G	H	J	K	L	M
C	30	24	.5	.75	10.207	5 D	3.802	5	12.169	7	2	5.324
	48	36	.75	1.25	15.291	8 D	5.924	6.805	19.454	11.208	3.202	8.086
	60	48	.75	1.25	20.615	10 D	7.405	10	24.318	10	4	6.925

N	P
9	1.875
13.530	3
16.812	3

TTC SIGN COLORS:
LEGEND — BLACK
BACKGROUND— ORANGE (RETROREFLECTIVE)

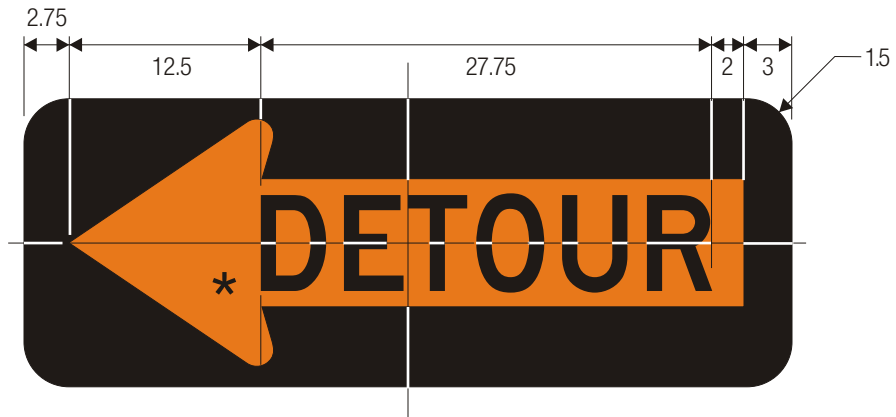

M4-10L
DETOUR (INSIDE ARROW)

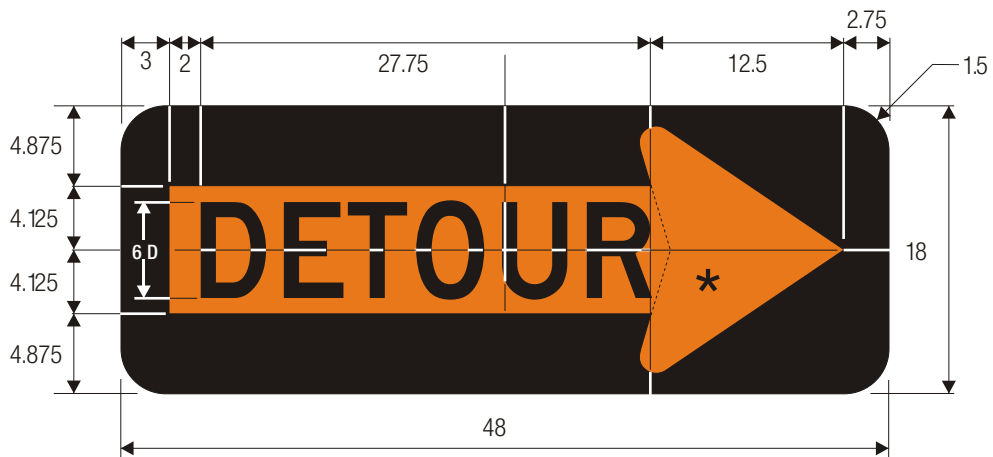

M4-10R
DETOUR (INSIDE ARROW)

*See page 6-2 for arrow design.

TTC SIGN COLORS:
 LEGEND — BLACK
 BACKGROUND— ORANGE (RETROREFLECTIVE)